

**THE DESIGN AND CONSTRUCTION OF MAJOR EXTENSIONS IN THE PORT
OF LIMASSOL FOR THE DEVELOPMENT OF A MODERN CONTAINER TERMINAL
BY**

D.K. Hallett, Director, Coode Blizard Ltd, Consulting Engineers UK
D.J. Pritchard, Principal Engineer, Coode Blizard Ltd, Consulting Engineers, UK
A.L. Edbury, Engineer's Representative, Coode Blizard Ltd, Consulting Engineers, Limassol, Cyprus

ABSTRACT

This paper describes the implementation of the first stage of the Master Plan for Limassol Port, the development of which is described in the companion paper by Meletiou. The paper describes projects valued at some \$100 million; the principal features are shown in Figure 1 and comprise.

- - construction of 670 metres of quays with an alongside depth of 14 metres.
- - construction of 500 metres of rubble mound breakwater.
- - execution of some 7,000,000m³ dredging and reclamation.
- - construction of some 400,000m² paved areas for container operations.

The first section of the paper shows how the requirements of the Port Master Plan were developed into the Design Brief, followed by the development of the design up to tender stage. In the second part, the construction is described, dealing particularly with areas where the particular constraints of the design led to unusual construction methods.

1. INTRODUCTION

Formulation of the Master Plan for Development of the Port of Limassol had continued throughout the eighties and culminated in 1990 in the commission to Coode & Partners to undertake the first phase of development. That first phase (known as Phase A) required the excavation of a new basin in the southern part of the port (then undeveloped), construction of two new quays in 14 metres of water, extension of the breakwater (the new quays being in a location exposed to swell entering the port), and construction of on-shore facilities for container handling.

This paper traces the evolution of the design, the tender process and the construction of the works.

2. DESIGN BRIEF

The Master Plan has set out the context of the works to be constructed, and in consultation with the Cyprus Ports Authority the following parameters were established for the designs:

- Generally
 - design to accepted codes of practice, these being principally British Standard 6349 Code of Practice for Maritime Works and British Standard 5400 and 8110 for concrete works, supplemented by the German Waterfront Code EAU 1985;
 - all aspects of design must take account of the earthquake risk; appropriate parameters have been established by a seismic study; no British Standard exists for seismic design, and detailing is to be carried out in accordance with New Zealand Code of Practice 3101.
- Breakwater
 - design for 100 year storm. Studies undertaken during the planning stage have established a design wave $H_s = 4.1\text{m}$; the alignment is fixed by the existing entrance channel;
- Quays
 - to be suitable for container handling; general loading 5 tonne/m² with panamax or post panamax cranes; rail gauge set at 25 metres to match existing facilities;
- Back of Port
 - suitable for container stacking (1 over 5) using rubber tyred gantry cranes; movement between stacks by terminal trailers.

Design requirements flowed from the Masterplan and the very extensive discussions held between the Consulting Engineer and the Cyprus Ports Authority. These have been summarised above, but it is of interest to note that an early part of the commission required the preparation of a Design Report which encompassed some 100 pages and 15 drawings.

3 DESIGN

3.1 Quay Structures - Choice of Structural Form

For master planning purposes, a quay structure had been shown which was similar to that finally chosen. At an early stage it was required to confirm the principles of the design, and various options were evaluated in terms of cost, speed of construction, seismic stability, wave reflection characteristics and durability (a 40 year design life was required). Wave reflection was considered important because hydraulic studies had shown that a high reflection coefficient could give rise to unacceptable wave conditions in the port. Six conceptual designs were evaluated using these criteria.

This study showed the clear superiority of a suspended deck on steel piles and this was the form adopted (Figure 2). Brief comments on the other standard forms are set out below:-

- Gravity walls - technically feasible, but unlikely to offer advantage in cost or time; high level of wave reflection; most durable option.
- Anchored steel sheet piles - technically difficult to design and heavily dependent ground conditions; unlikely to offer advantage in cost or time; high level of wave reflection; durability may be a problem.
- Anchored concrete diaphragm wall - construction simple but design of anchors may be difficult; programme disadvantages arising from need to construct from dry land; high level of wave reflection, but could be mitigated by special design features; durability satisfactory (with care).
- Cellular steel cofferdams - technically feasible and competitive cost; time neutral but could face difficulty with driving small pile sections; durability doubtful in the steel sections.
- Cellular concrete diaphragm walls - technically feasible, but would require (and be limited to) specialist contractor; competitive in time and cost; durability satisfactory.

3.2 Quay Structures - Design.

Consideration of the loads to be applied to the structure (each Post Panamax crane was estimated at 1000 tonnes), showed that the piles (unless placed at unacceptably close centres) would be required to carry high vertical loads, whilst earthquake forces would apply high lateral loads. These requirements, together with the practical requirements to drive piles through variable strata and into rock made the choice of steel piles almost automatic. Similarly a concrete deck is an obvious choice, and a precast system was chosen to minimise in-situ work whilst at the same time making it easy to provide high quality concrete (especially in the soffits) to ensure durability.

Individually, the design requirements for the quays are unremarkable, but collectively they place an onerous burden on the designer; nowhere is this more evident than in the load cases considered. For most non-complex structures, the designer would consider perhaps 3 or 4 principal load cases, together with dead and live loads; for the Limassol quays no fewer than 45 cases were fully evaluated by computer analysis.

From the structural analysis, detailed design followed for the individual members, using procedures set out in the design codes. The form of precast units was chosen to minimise in-situ shuttering requirements, and indeed none is required other than to seal joints between units. Design is fully composite, with precast units supporting construction loads, but acting compositely with in-situ concrete in respect of live loads.

In general, detailed design was straightforward. However, the limited structural depth (quay deck level is relatively low, defined by existing structures, and it was desirable to keep the deck structure well above the splash zone) required

beams to be very heavily reinforced. This, coupled with the need to ensure a high degree of structural continuity at the pile head has led to the complex design shown in Figure 3.

In view of the commercial importance of the quays, the structure is designed to behave elastically under "normal" earthquake loads; plastic behaviour but not collapse is assumed under an extreme event. In order to share loads more equally in the plastic condition, the front piles are (unusually) of a heavier section than those at the rear of the quays. Ideally, individual piles would have a section related to their length; for practical reasons only two section were chosen.

Reference has been made to durability. Concrete sections have been specified with high grade concrete, high cement content, substantial cover, and in addition contain 10% microsilica, and these are considered sufficient to ensure the required 40 year life. Steel pile sections require specific protection, and although painting was considered, it was felt that there would be problems of quality control, and that in any event the required design life would not be achieved without maintenance which would only be possible above water. An impressed current cathodic protection system was therefore specified, supplemented by a petrolatum tape wrap system in the tidal and splash zones where cathodic protection would be ineffective.

3.3 Breakwater Design

The alignment of the breakwater was determined by the presence of the existing entrance channel, while the length was determined during hydraulic studies carried out as part of the Master Plan development. In the absence of any restrictions, the decision to use a rubble mound breakwater was easily made, and consideration then turned to choice of armouring.

The existing breakwater, which had performed satisfactorily had been designed using 22 tonne concrete block armour on a rubble core. The firm had had experience of using natural stone armour for a similar structure in Larnaca, but investigation showed that, even if transportation were feasible, the source used was no longer available. Investigations of possible sources of stone near Limassol showed that rock was unlikely to be available in the necessary sizes and that quality, at best, would be marginal. It was therefore decided that the primary armour would have to be of concrete units.

A wide range of concrete armour units exists, but the firm had developed and used the COB unit, and its characteristics were well known. The unit has already been used on structures of similar height and subject to a similar wave climate, and since the unit is laid in a single layer on a relatively steep slope, its economy was easily demonstrable. The COB armoured breakwater was therefore model tested in both 2-dimensional and 3-dimensional modes and after some adjustment to the alignment at the roundhead, the design was confirmed, and is shown in Figure 4.

3.4 Dredging and Reclamation

A central feature of the project is the excavation of the new West Basin. This is sized in accordance with the requirements of the Master Plan and provides space for quay extensions well into the 21st Century.

Primary function of the dredging is to provide the water depths appropriate to large modern container vessels. As a result of this, large quantities of material suitable for reclamation were generated and were available for the port construction. The phase A development therefore provides for extensive reclamation behind the new quays to bring these up to the general level of other port areas, and also provides for reclamation on the line of future quays on the south side of the basin. Even with this extensive reclamation (some 1Mm³) a substantial surplus was available and this was used to reclaim an area outside the port boundary to the south, and to form a stockpile there for future use.

Substantial dredging was also undertaken on the line of the quays to remove a weak layer (the *Poseidonia* seaweed) which might otherwise have proved a weakness under seismic loading. This material was replaced with a rock bund (of a size expected not to impede pile driving) and reclaimed material from dredging. Similar dredging and replacement was carried out on the line of future quays on the north and south sides of the West Basin.

Although the results of extensive borehole investigations were available, these had generally not been carried out with dredging in mind. The opportunity was therefore taken, when dredging was being carried out for the Authority in Larnaca to bring the trailing suction dredger *Atlantique* to Limassol to carry out trials in the turning circle and entrance channel. These trials confirmed the general dredgability of materials, and also showed that turbidity arising from the dredging options was unlikely to be environmentally unacceptable. An Environmental Impact Analysis, carried out separately enabled a suitable spoil ground to be located in deep water (100 fathoms) at some 5km from the port.

3.5 Back of Port Works.

Four stages of development of the Back of Port Works were planned within the Phase A Development, in all totalling some 400,000m². Overall planning of the whole area has been carried out, and construction of the second stage of paving is now in hand, making some 180,000m² available for port use.

Although concrete block paving was chosen for paved areas, the Port Authority has extensive experience of gravel bed stacking areas behind the east quay. Use of this system, with modern purpose built handling plant, allows a high stacking density, making optimum use of available space (Figure 5). Service provisions within the stacking areas are limited to drainage, water supply (principally for fire fighting) and medium voltage electricity serving high mast lighting. On the perimeter of the stacking areas adjacent to the quays, there is in addition high voltage cabling serving the container cranes and low voltage cabling serving the cathodic protection to the quay structures.

Design of the gravel bed stacking areas is empirical, based on our previous experience within the port. In practice, the ground will not support the loads under the corner coastings, and containers are then supported over their full length, giving rise to low overall ground pressures which are easily supported by the reclaimed materials underlying the beds. Drainage is provided at the centre of each gravel bed, and separation membranes adjacent to the roadways ensure that the substructures of these remain dry.

Design of the paved areas follows the recommendations of the Port Paving Manual. Within the gravel bed stacking areas, the ruling wheel load is that arising from the rubber tyred gantry crane, and the paving is locally thickened in these areas where wheel loads are generally channelised. Elsewhere, the paving is designed for terminal trailer traffic and/or stacking of empty containers by forklift. At intersections of gantry runways and roadways, steel turning pads are set into the paving to allow the gantries to change direction.

A workshop for maintenance of container handling equipment is included in the second stage of the Back of Port Works. Later stages include for a container freight station, which will replace the two smaller facilities presently in use.

4. CONSTRUCTION

4.1 Dredging and Reclamation

The required depths of dredging to suit the design parameters were -19.5m for the Breakwater Extension, -17.5m for aprons in front of quays, -15m in Entrance Channel and Turning Circle, and -14m general depth within the port.

In the new West Basin, the area of dredging necessitated removal of material, from an existing ground level of +1.5m; this included an upper layer 6m thick of fine sand with cobbles, ie. to a depth generally to -4.5m, which was good reusable material for reclamation fill purposes. 1.3Mm³ reusable material was excavated in the dry to utilise the ready availability of land-based plant instead of by conventional dredging. This reusable material was used behind the new quays and to form the reclamation of the future quays in the West Basin.

The surplus reusable material was stockpiled in a reclamation area 300m x 300m specially constructed as part of the contract works south of the port boundary and protected by a simple rock bund (construction to +2.0m level of 37,000m³ of core stones of 1kg to 1000kg grading) built out from the beach adjacent to the existing Main Breakwater. The material was stored there for use in future phases of port extension.

Most of the dredged material had to be removed from the existing seabed in the existing port area, and from low levels (ie below -4.5m level) of the new West Basin and this quantity, 6Mm³, generally comprised of fine silty sand, and clay, and was unsuitable as fill. This contract specified the offshore disposal of this unsuitable dredged material to be within 500m of the designated point some 5km offshore.

Additionally, the Authority sold 50,000m³ of reusable dredged material to local companies who obtained Cyprus Government licences to use the material as earthfill. Licences were issued to control and prevent misuse in building construction to minimise risk of alkali silica reaction in concrete, a known high risk in Cyprus.

Dredging was undertaken by three dredgers; these were a suction/trailer, "DNESTROVSKY LIMAN" (hold capacity 1300m³), and two bucket dredgers, "GENICHEVSK" and "ILYCHEVSK" (both of output 750m³/hour).

The dredging production averaged some 350,000m³ per month dredged during the 20 months of programme, including approx 80,000m³ per month of suitable material excavated from the dewatered area by landbased plant during the first 17 months of the programme.

4.2 Breakwater Extension Works.

The 500m long Extension of the existing Breakwater (Figure 4) was a major item in the Marine Contract and needed a very substantial quantity of rock of durable quality and of size to suit secondary armouring parameters (5t and 3t limits).

To put the scale of the Breakwater Extension structure in context, the following statistics are supplied:-

<u>Structure Height</u>		<u>Foundation Width</u> (
Foundation level	- 19m (mean)	Landward slope	1:1.75
Crest Roadway Level	+ 4m	Seaward slope	1:1.33
Mean Height	= 23m	Berm 8m wide at -8.75m level on seaward slope	
		approx. width at seabed	=85m
<u>Rock Quantities</u>			
Foundation (700mm thick)	= 42,000m ³		
Core including tertiary armouring	= 650,000m ³		
Armouring, Secondary	= 77,000m ³		

Total rocks	=769,000m ³		

The precast concrete elements incorporated into the design were:-

22t blocks	80 (existing roundhead) (unreinforced Grade 20 concrete)
Toe	604 (footing for COBS) (unreinforced Grade 30 concrete)
Roadway	264 (single, double wave walls) (unreinforced Grade 30 concrete).
Armouring units	10,300 (COBS) (reinforced Grade 40 concrete).

Recognising the scarcity of rock sources to meet the projects needs, the Authority arranged prior to the tendering procedure for the Geological Services Dept. (G.S.D), a Cyprus Government Dept, to investigate suitable locations for quarries. The G.S.D. located two possible quarry sites and two boreholes per site were drilled and logged. Details of the borings was made available to tenderers during the tender period. The suitable rock found by G.S.D. was calcarenite, a bioclastic limestone sedimentary rock. The Authority obtained two quarry licences in the name of their executive Department the Ministry of Communications and Works, and the licences were available to the Marine Contractor from the outset avoiding a lengthy delay.

The location of the 1st Licensed quarry was Kato Polemidhia, some 12km from the site. Quarrying was undertaken by subcontract awarded to a local company who already operated their own quarry adjacent to the Authority's licenced quarry and thereby providing readymade access and basic facilities. During the contract further three adjacent areas were found to be needed and licences for these were also obtained by CPA and operated by the Contractor under additional Agreements. The overall area quarried in Licences Areas 1 and 2 to date was 120,000m² which produced over 600,000m³ of rocks after overburden removal to reach the bench of calcarenite, which was found to exist in bed thickness ranging between 10cm and over 2m.

The Subcontractor erected a simple screening station in the quarry for production of breakwater core material and to eliminate fines. The large grades of rock were selected from the blast products.

On site screening has been carried out by the Contractor to produce some categories of materials for bedding of precast concrete units in the Breakwater Construction. Further quarry extensions Nos. 3 and 4 each of approx, 90,000m² area, and to the north and south of Areas 1 and 2, have been given provisional Licence approval for use and development as needed, and these will be quarried and reinstated as part of the Contractor's overall Environmental Management Plan.

4.3 Breakwater Construction

Dredging of the seabed to firm (clay) material and placing of filter layer by split barge was followed by transporting lower core rocks (1kg to 1000kg) which were placed by split barge to -11.25m level. Approx 30,000m³ of 0.1kg to 30kg grading was included for economy reasons in the lower core. A temporary sheetpiled jetty constructed on the West Basin specially for this purpose was used for the loading of barges. Upper core (10kg to 1000kg) was placed by split barge to -3.50m level after which upper core was transported by truck via the existing roadway on the Breakwater and back tipped by loader down the leading face of the new Breakwater crest, to bring the level to +3.35m level. A floating crane equipped with clamshell shaped the core to the approximate profiles up to sea level, and above sea level shaping was done by excavator and grab.

The leeward face and the apron slope of the seaward face were armoured using 3t rocks loaded on flat barge from the jetty and placed underwater using a grapple equipped floating crane. The placing of leeward face above sea level was carried out using dump trucks to transport the rocks and by excavator fitted with a grapple.

Armouring of the seaward face incorporated the phases of preparing the apron, screeding it, and placing toe units. With a steel screeding frame placed on the apron a 30cm layer of bedding rocks (10kg to 30kg) at -9.9m level was prepared by use of floating crane and clamshell guided by divers. A layer of finer material (0.1 to 1kg) was used to flush up the bedding surface and toe units were then placed on this bed, having been transported by flat barge. Alignment, carefully controlled by surveyors using plumb bobs, was achieved using a pegged line placed by diver.

The screeded slope for COBs was constructed in two layers, and also prepared to final level by screeding frame 5m wide x 17m long filled by 10 to 50kg rocks levelled in by divers for the 13 rows of COBs up to sea level. COB placing was carried out by divers after a 4-column wide slope area of restricted grading was ready. The COB units were transported by flat barge, then by truck when upper core was built up sufficiently. A frame to suit the 1:1.33 slope was used for lifting the COB units, in rows of 4 to match the width of prepared bed, but supported individually on the columns built up from toe units which supported each column of COBs. Phases of construction above sea level were completed by land based mobile crane and transporting of material by truck. The sequence of construction incorporated 3 No. floating cranes and attendant barges as displayed in the attached plan layout (Figure 6).

The Contractor achieved a combined rock placing rate of 43,000m³/month (lower core), +14,000m³/month (upper core) during a 12 month overall period. Placing of COBS units averaged 30 per working day, with peak up to 100 per day, but the critical activity was that of preparing the screeded layer to receive the COB units which generally dictated the overall advancement of armouring.

4.4 Quay Construction.

The quay deck is supported by 1036 bearing piles at 5m centres with 8 piles per bent totalling 8,260 Lin.m of 762 dia. (rear 2 rows) plus 16,870 Lin.m of 813 dia. steel tubes, 25mm wall thickness. Steel quality is to BS En 10025 Grade Fe 510B, and supplied in 12m and 14m nominal lengths; three separate orders enabled data derived from actual piling records to be used to match the total quantity closely to requirements.

Using full and half lengths of tubes joint welding produced fabricated piles in 20m, 22m and 24m lengths for 762 dia. and lengths from 21m to 40m for 813 dia. piles. A temporary site fabrication pile welding yard was prepared with two production lines of sets of rollers supported by concrete plinths on which the pile tubes were rotated during the joint welding. The 28 welders employed on this work were qualified and tested at site for 5G position (17 welders) and for 6G position (11 welders) for shield metal arc welding. During peak programme production (October '93/February '94 and October '94) a nightshift was worked. Radiographic tests were carried out on circumferential joints, making one radiograph 300mm long for 10% of the joints. The ASME Boiler and Pressure Vessel Code, Section 8 was used to define the acceptance standard for defects.

All circumferential joints were also visually inspected and the straightness of two or more jointed lengths were checked to meet the deviation of $\frac{1}{960}$ of the total length.

Pile load tests were carried out on one each of 762 dia. and 813 dia. piles in Container Ro/Ro Quay, and on one 813 dia. in Container Quay, under test load of 5400kN, ie. twice working load. A reaction pile rig of 3 x 3 grid of piles around the central pile under test was temporarily driven to a toe level 0.5m less than test pile; on the central (reaction) piles on each side of the grid a heavy steel beam structure was attached, against which a 600t hydraulic jack was used to

jack test pile at specified intervals of load and times up to the maximum test load and then back to zero load. Driving sets were evaluated using the Hiley formula varying from 35 blows for a 20m pile to 41 blows for a 28m pile.

The Contractor constructed a temporary pile driving platform for six piles per platform supported by four temporarily driven piles. This was superseded by a driving platform welded to the barge platform of the "POSIDONIA" floating crane equipped for the full eight piles per bent and with which pile driving production improved markedly.

Pitching of piles was accomplished using a vibrohammer and vibrating the piles to 4m depth; driving to set with minimum penetration of 10 diameters from ground level was completed using a diesel hammer. Pile position monitoring was maintained by surveyors throughout driving to try to control to the final pile position within 75mm of the theoretical specified by the designer to avoid fit-up problems of precast deck beams. The majority of piles complied but some 20% were outside and at worst 213mm from theoretical. With extra stirrups and modified bundle bar steel fit of beams was never a problem of any magnitude. All out of position piles were surveyed, recorded and a remedial proposal of rebars carefully checked and approved.

The pile driving production averaged 8 piles per working day through the main programme period, and was only seriously disrupted awaiting arrival of the 3rd pile order; milestone dates for taking-over of completed quays by the Authority were fully met.

Precasting of transverse beams 1.11m deep and longitudinal beams 0.61m deep totalling 2,420 in all, and 1265 soffit slabs 0.2m deep area of 4m x 3.5m and 2m x 3.5m 2/3rds of the slab units being variants to accommodate services, quay fittings and then design features, all were cast on a temporary site casting yard and completed in a 14 months duration programme.

Concrete quantities placed in the works were 1380m³ C20, 4500m³ C30, and 37,400m³ C40 with 70% of C20 and all C40 containing microsilica; and 720m³ C40 in Ro-Ro Ramp deck also included Dramix steelfibres. The reinforcement was generally heavily congested in the pile junctions, and a total of 5666 tons of rebars were fixed in 25,950m² of new deck.

The deck construction followed a phased sequence of detailed activities as follows:-

- - preparation of dredged foundation and 1st stage revetments before piling.
- - piling stage, and 2nd stage revetments after piling;
- - 1st stage of deck = placing precast units, weld lap bars cast pile junctions and services pits under deck soffit;
- - 2nd stage of deck = concreting insitu surfacing, fixing crane rail chairs, rails, bollards, ladders, fenders, crane buffer stops, services pit covers, crane cable slot covered by proprietary rubber cover.

During deck construction the skills of the welders were of great benefit to the Contractor who opted to weld lap rebars projecting from beams in pile junctions instead of using mechanical couplers and this option provided greater flexibility for construction tolerance.

The Contractor's initial deck soffit system supported on temporary steel brackets clamped to each pile head was tried then abandoned and replaced by permanent reinforced concrete brackets cast on each pile head which supported the permanent precast deck beams until the pile junctions were cast. This revision was greatly beneficial in enabling the Contractor to meet his programme commitments for handing over the quays on time.

4.5 Back of Port Works

For port operational reasons to enable container storage areas to be taken out of service for resurfacing, the area of paving in Phase "A" of the Master Plan was separated and let in two contracts designated Stage 1 and Stage 2 and restricted to local (Cypriot) contractors.

Stage 1 Paving contract covered an area of 60,000m² of previously derelict land in the north west corner of the Port beyond the Grain Silo. In a 9 month programme March to December '93 the works comprised site clearance, excavation, and filling to suit paving profiles, installation of surface water drainage and outfall, water supply, services ducts for H.V., M.V and telephone supplies, seven light mast bases, new pumping station, and heavy duty pavement.

The pavement details included sub-base of 150mm thick crusher run (compacted to CBR 30%), Grade 21 concrete base course 275mm thick, and 80mm thick paving blocks placed on 50mm thick sand bedding, and finished with a sealer coat.

The block paving specified by the Engineer in compliance with B.S. No. 6717 Part 3 was a herring-bone pattern using 100mm x 200mm rectangular paving blocks, with average corrected compressive strength 49N/mm^2 .

The contractor purchased two block paving machines and his proposal was adopted of an alternative paving block of extended hexagonal shape which eliminated hand-placed infill blocks at the edges of the pallet size areas placed by the machines. The Contractor also automated the construction effectively by using an asphalt spreader for sub-base, and a concrete slipform paver type for the base-course achieving 200m^3 of base course per day and enabling the completed works to be handed over on time.

The Stage 2 contract, was awarded to the same contractor after competitive tender. This comprised of $101,000\text{m}^2$ of paved area, which also included a new Workshop complex, and required completion in 15 months overall. The area has incorporated a part of existing container facilities, together with the newly reclaimed back of port area behind new container quays, and combining all within the Phase "A" surfacing profiles. The exhibited design of 100 x 200mm paving block was again replaced by the extended hexagonal shaped block to suit the repeated production system by machine laying. Base course concrete in this contract was enhanced to 350mm nominal thickness and average daily production was 350m^3 . Phased sectional hand-overs of the works will permit the extension works of the Port to be improved with minimal obstruction to on-going operations.

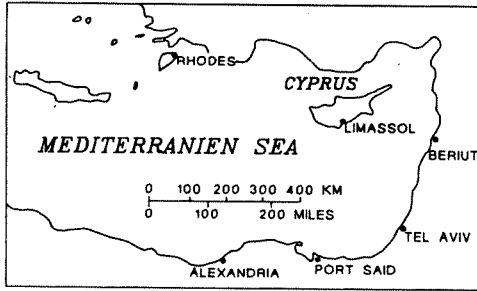

LOCATION PLAN

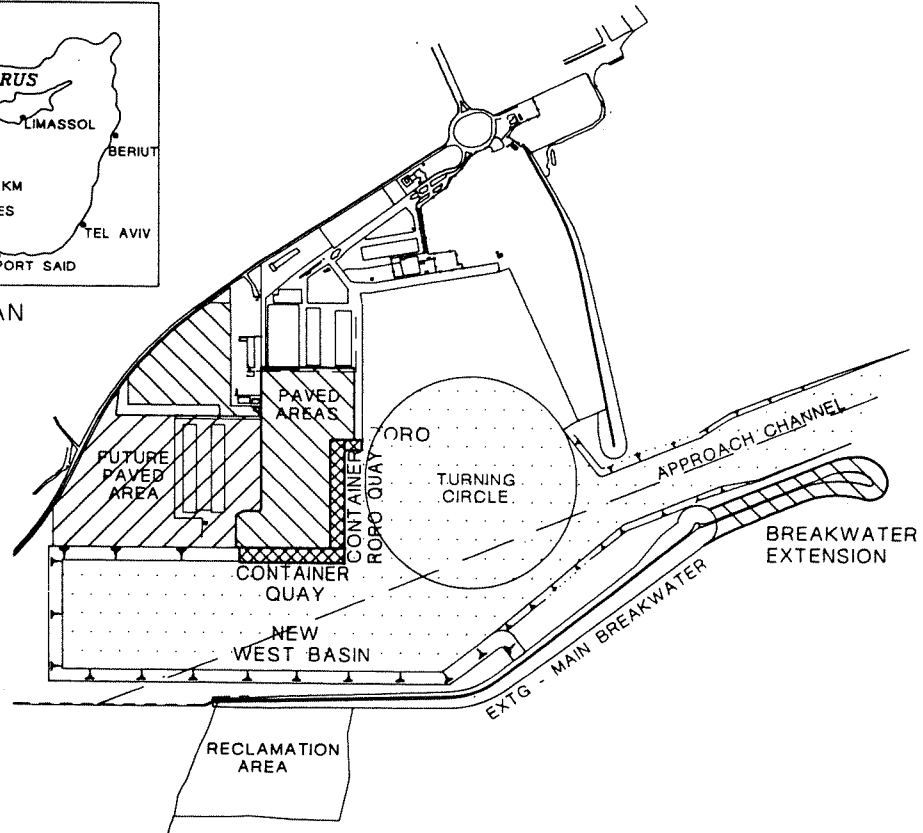

PORT OF LIMASSOL

FIGURE 1

FIGURE 2

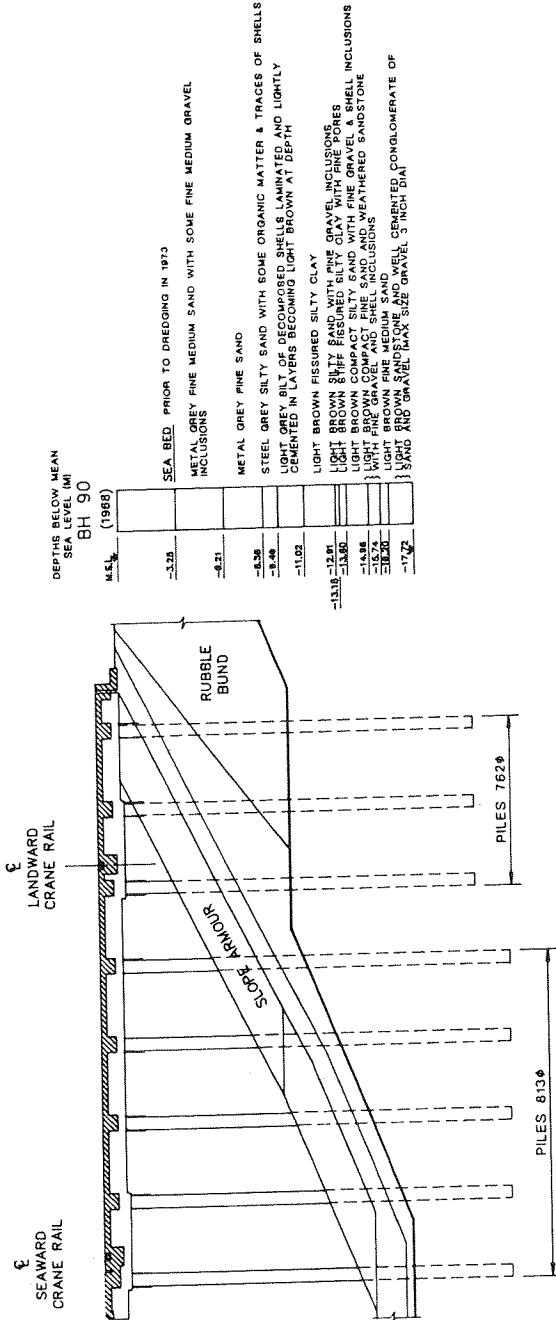

CROSS SECTION OF QUAYS

FIGURE 3

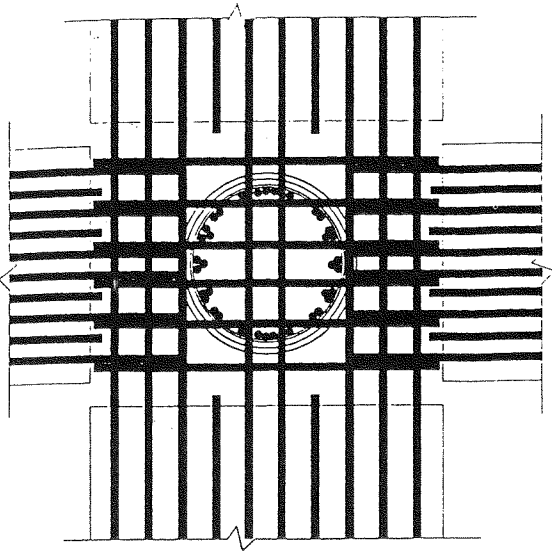

TYPICAL JUNCTION REINFORCEMENT
(BOTTOM)

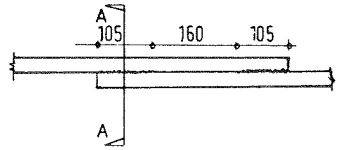

PLAN

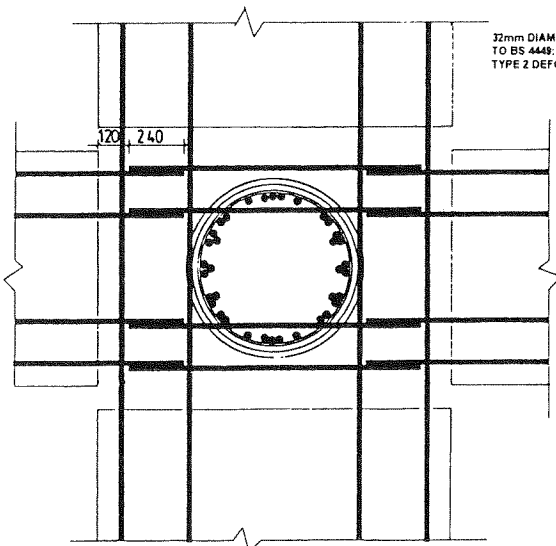

TYPICAL JUNCTION REINFORCEMENT
(TOP)

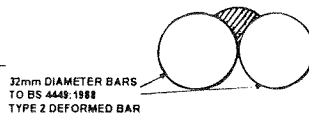

SECTION A-A

32mm DIAMETER BARS
TO BS 4449:1988
TYPE 2 DEFORMED BAR

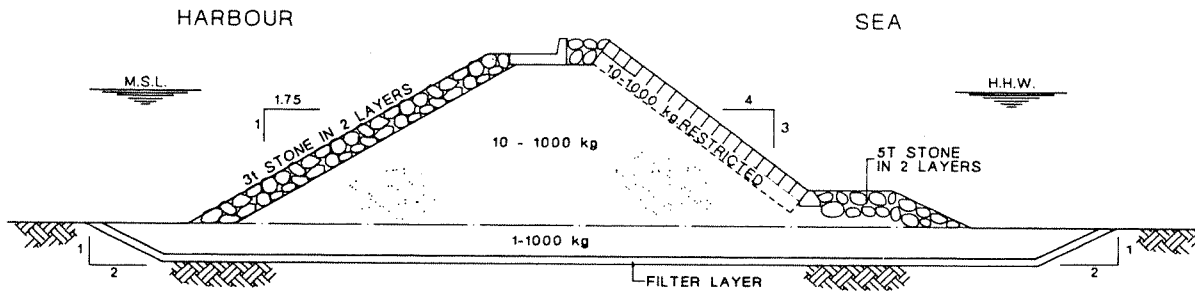

GENERAL SECTION THROUGH BREAKWATER

FIGURE 4

FIGURE 5

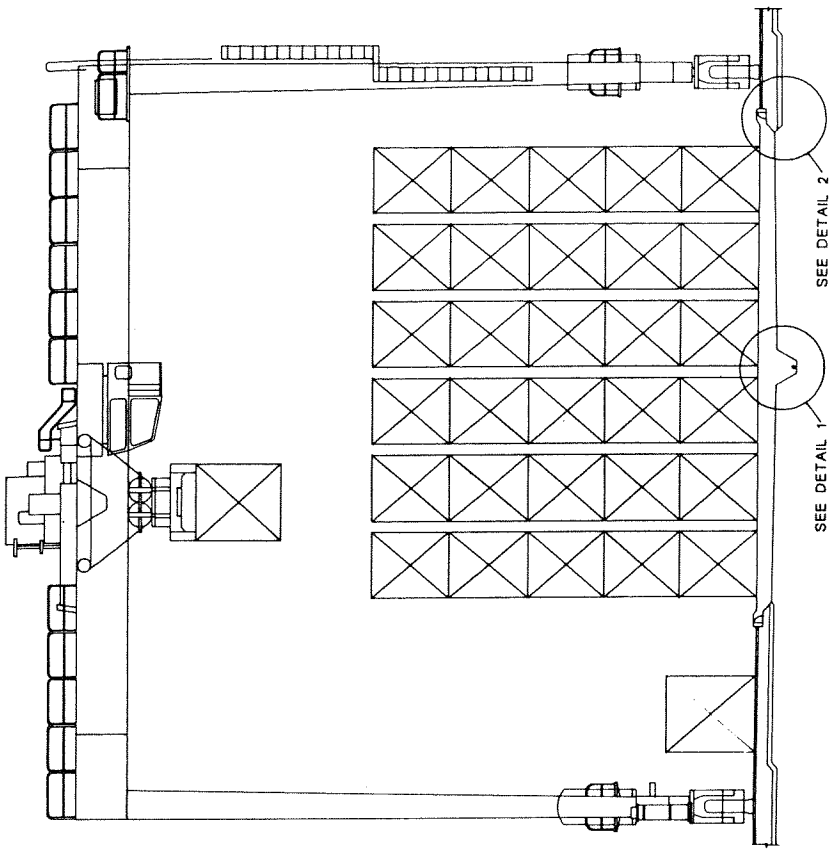

GRAVEL BED CONTAINER STACKS

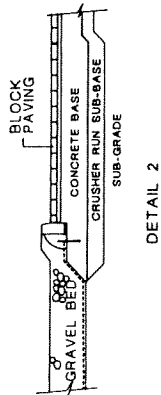
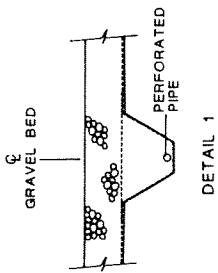

FIGURE 6

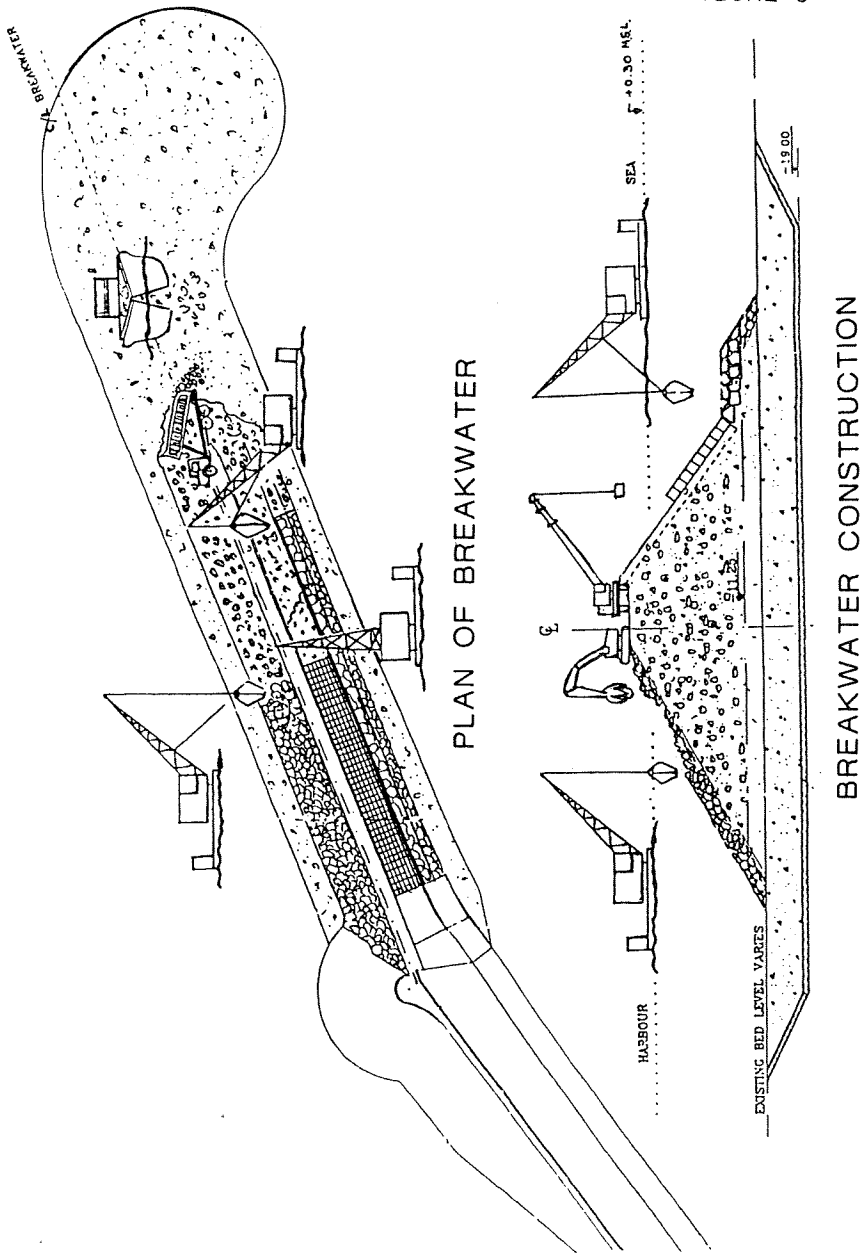

FIGURE 7

