

6 Design of marine structures



1

2

3

4

5

6

7

8

9

10

CHAPTER 6 CONTENTS

6.1 Rubble mound breakwaters.	778
6.1.1 General aspects	778
6.1.1.1 Design considerations and overall approach.	779
6.1.1.2 Definitions.	780
6.1.1.3 Selection of breakwater type	782
6.1.2 Plan layout.	783
6.1.2.1 Influence of the need for berth protection	785
6.1.2.2 Influence of the need to provide protection to access channel	785
6.1.2.3 Influence of the need to reduce maintenance and dredging costs	787
6.1.2.4 Effect of the layout on the breakwater sections.	787
6.1.2.5 Effect of the breakwater sections on harbour layout.	788
6.1.2.6 Cost considerations.	788
6.1.3 Geometry of breakwater cross-section	789
6.1.3.1 Cross-section concept generation, selection and detailing	789
6.1.3.2 Data collection and boundary conditions	790
6.1.3.3 Materials availability	790
6.1.3.4 Failure analysis	791
6.1.4 Conventional rubble mound.	793
6.1.4.1 Main dimensions.	793
6.1.4.2 Detailed dimensions	798
6.1.4.3 Transitions.	801
6.1.5 Rubble mound with monolithic crown wall	803
6.1.6 Berm or S-slope breakwater	808
6.1.6.1 Main dimensions.	809
6.1.7 Caisson-type breakwaters	811
6.1.8 Cost aspects	814
6.1.8.1 Cost aspects related to the production of armourstone for breakwaters	815
6.1.8.2 Cost aspects related to design and construction of breakwaters.	817
6.1.9 Construction issues that influence design	819
6.1.9.1 Construction method	819
6.1.9.2 Placing tolerances	820
6.1.9.3 Construction risks.	821
6.1.10 Maintenance issues that influence design.	821
6.1.11 Repair and upgrading of existing structures	822
6.2 Rock protection to port structures	823
6.2.1 General aspects and definitions	823
6.2.1.1 Types of structure	823
6.2.1.2 Key properties	825
6.2.2 Plan layout.	826
6.2.3 Cross-section design and structure details	826
6.2.3.1 Design loads and armourstone size	826
6.2.3.2 Vertical dimensions.	827

6.2.3.3	Horizontal dimensions	829
6.2.3.4	Slope angle	830
6.2.3.5	Armour layers	830
6.2.3.6	Underlayers and filters	830
6.2.3.7	Toe details and terminations	831
6.2.3.8	Transitions and junctions	831
6.2.3.9	Crest details	831
6.2.4	Alternative materials	832
6.2.5	Cost aspects	833
6.2.6	Construction issues that influence design	834
6.2.7	Maintenance issues that influence design	835
6.2.8	Repair and upgrading	835
6.3	Shoreline protection and beach control structures	836
6.3.1	General aspects and definition of structure types	837
6.3.1.1	Revetment	838
6.3.1.2	Scour protection	838
6.3.1.3	Groyne	839
6.3.1.4	Detached breakwater	840
6.3.1.5	Fishtail groyne	841
6.3.1.6	L-shaped and T-shaped groynes	841
6.3.1.7	Sill or submerged breakwater	842
6.3.2	Plan layout	842
6.3.2.1	General layout considerations	842
6.3.2.2	Plan layout for different structure types	844
6.3.3	Geometry of cross-sections	851
6.3.3.1	General considerations	851
6.3.3.2	Physical boundary conditions	852
6.3.3.3	Overtopping	852
6.3.3.4	Slope design	855
6.3.3.5	Armour layer	855
6.3.3.6	Underlayers and filters	856
6.3.3.7	Layer thickness	858
6.3.4	Structural details	859
6.3.4.1	Toe design	859
6.3.4.2	Crest design	866
6.3.4.3	Joints and transitions	867
6.3.4.4	Structure-specific aspects	869
6.3.5	Cost aspects	879
6.3.6	Construction issues that influence design	881
6.3.7	Maintenance issues that influence design	882
6.3.8	Repair and upgrading	882
6.4	Rockfill in offshore engineering	883
6.4.1	General aspects and definitions	883
6.4.1.1	Pipelines and cables	884

1

2

3

4

5

6

7

8

9

10

6.4.1.2	Slender structures (monopiles)	885
6.4.1.3	Concrete gravity structures (CGSs)	885
6.4.2	Layout	885
6.4.3	Design aspects	885
6.4.3.1	Design approach	887
6.4.3.2	Hydraulic stability	888
6.4.3.3	Morphological changes (sandwaves)	889
6.4.3.4	Geotechnical stability	889
6.4.4	Structural considerations	890
6.4.4.1	Stability against impacts of dropped objects	890
6.4.4.2	Stability of rock berm against dragging anchors	892
6.4.4.3	Stability of rock berm against fishing gear (trawling)	894
6.4.4.4	Pipeline stability against upheaval buckling	894
6.4.4.5	Stability of freespans	897
6.4.4.6	Scour protection for slender structures (eg monopiles)	897
6.4.4.7	Scour protection for large structures (CGSs)	899
6.4.5	Cost aspects	901
6.4.6	Construction issues that influence design	902
6.4.6.1	Construction methods	902
6.4.6.2	Impact of dumped rock	902
6.4.6.3	Survey	903
6.5	References	905

6 Design of marine structures

Chapter 6 explains how to design rock structures exposed to waves in the marine environment.

Key inputs from other chapters

- Chapter 2 ⇒ project requirements
- Chapter 3 ⇒ material properties
- Chapter 4 ⇒ hydraulic and geotechnical input conditions
- Chapter 5 ⇒ parameters for structure design
- Chapter 9 ⇒ construction methodology
- Chapter 10 ⇒ maintenance considerations.

Key outputs to other chapters

- **structure design** (cross-section and plan layout) ⇒ Chapters 9, 10.

NOTE: The project process is **iterative**. The reader should **revisit Chapter 2** throughout the project life cycle for a reminder of important issues.

This flow chart shows where to find information in the chapter and how it links to other chapters. Use it in combination with the contents page and the index to navigate the manual.

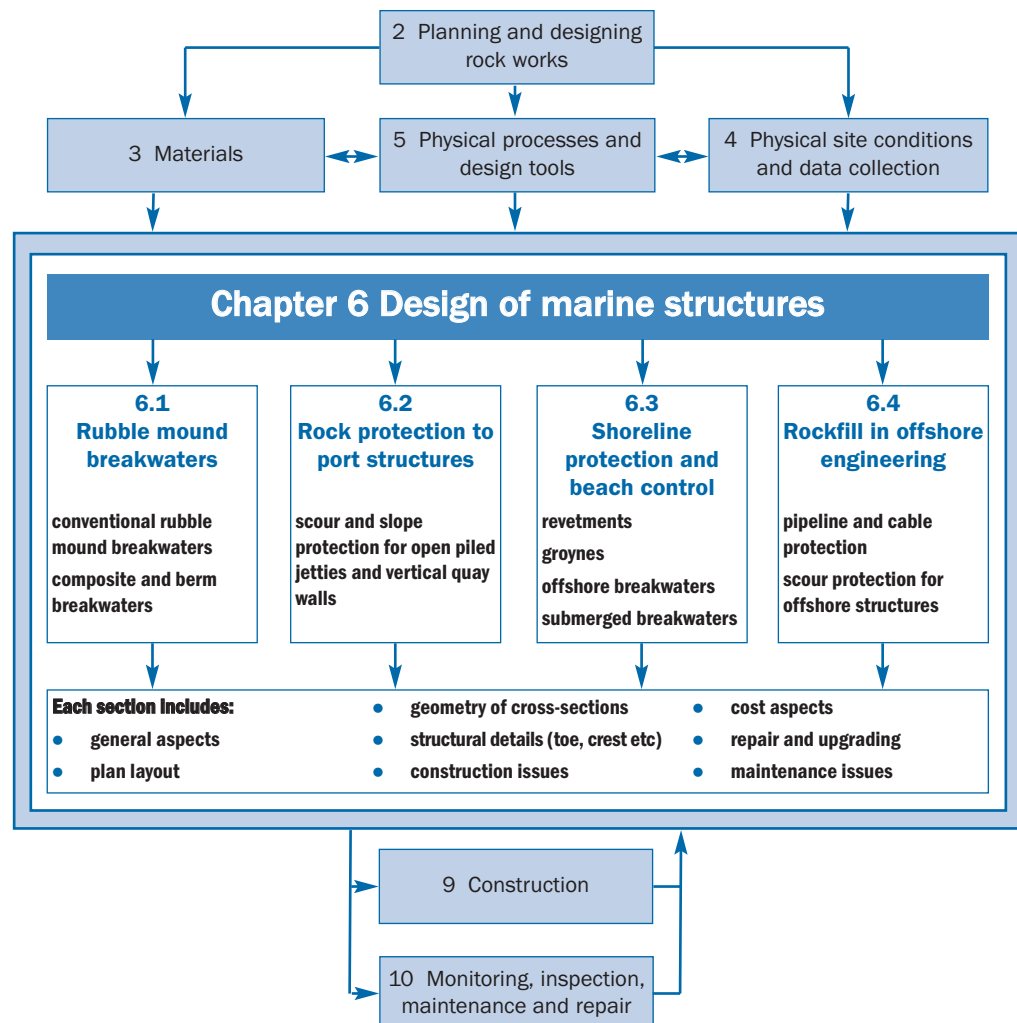

6.1 RUBBLE MOUND BREAKWATERS

6.1.1 General aspects

This section describes the general considerations for the structural design of rubble mound breakwaters. It includes discussion of (composite) caisson breakwaters where these are founded on rubble foundations. Only the design aspects for the rubble mound component of caisson structures are discussed. This section covers design considerations for defining the layout and overall shape and dimensions and structural details for breakwaters. Construction, cost aspects, repair, upgrading and maintenance of the structures as part of the design parameters are covered.

Rubble mound breakwaters are structures built mainly of quarried rock. Generally, armourstone or artificial concrete armour units are used for the outer armour layer, which should protect the structure against wave attack. Armour stones and concrete armour units in this outer layer are usually placed with care to obtain effective interlocking and consequently better stability.

The cross-section of a conventional rubble mound structure usually has a simple geometry, often with a trapezoidal cross-section with side slopes of typically 1:1.33 to 1:2. In some cases, a berm may be incorporated into the design to increase wave energy dissipation and to permit the use of smaller armourstone gradings. This concept is called a *berm breakwater*. The design may allow for some initial movement of the stones on the berm until an equilibrium profile is reached.

Rubble mound breakwaters are often a preferred design solution because their outer slopes force storm waves to break and thereby dissipate their energy, causing only partial reflection. They are also numerous because:

- rock is generally available and armourstone can often be supplied from local quarries
- when artificial armour units are required they only call for simple construction techniques
- even with limited equipment, resources and professional skills, structures can be built that perform successfully
- appropriately designed structures experience only a gradual increase in damage once the design conditions are exceeded, resulting in gradual rather than rapid degradation. The exception to this point is when interlocking concrete armour units are used for armouring (see Section 5.2.2.3). In this case, once damage commences, failure of the armour can be rapid as movements cause the units to break. Thus these structures are usually designed with sufficient safety margin or *stability reserve*, for example by testing for conditions in excess of the design loading. Design or construction errors can mostly be corrected before complete destruction occurs. This is of particular importance where local wave conditions are not well known. Repair works are relatively easy and rarely require mobilisation of highly specialised equipment, particularly if access is provided along the crest of the breakwater that enables land-based plant to be used
- the structures' flexibility means they are not very sensitive to differential settlements. The exception to this point is when a rigid concrete roadway or crown wall is located on the crest, which may tolerate only very limited differential settlements. The sloping faces and wide base assist in spreading the load and often foundation requirements are less than for a comparable vertical structure placed directly on the sea bed.

6.1.1.1 Design considerations and overall approach

Issues to be considered during concept generation, selection and detailing of a rubble mound breakwater are summarised in Figure 6.1. The numbers refer to the relevant parts of this section.

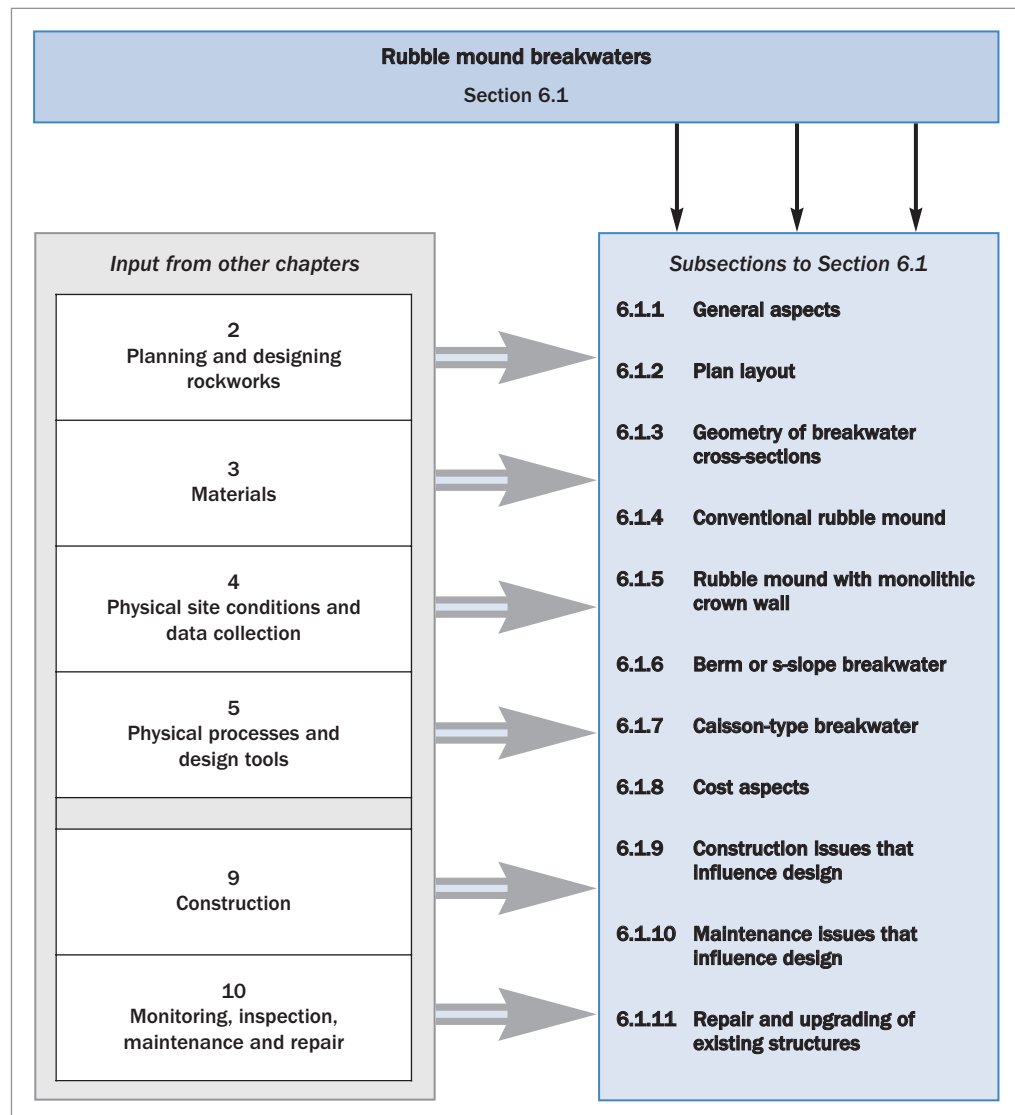

Figure 6.1 Flow chart for design of rubble mound breakwaters

Compared with other structures such as vertical breakwaters or piled jetties, conventional rubble mound breakwaters make use of a greater volume of natural material. Consequently it is of utmost importance to study carefully the availability of material and to analyse the cost implications for the proposed construction method.

Key design considerations include the following:

- use of the facilities to be protected (such as quays, docks etc) and extent of the protection required
- layout of the port or harbour (see Section 6.1.2)
- acceptable downtime
- design life of the port or harbour facilities and thus of the breakwater (see Section 2.3.3)
- acceptable risk during the lifetime of the structure (see Section 2.3.3)
- level of tolerable maintenance and ease of operation (see Section 6.1.10 and Chapter 10)
- acceptable architectural appearance
- acceptable impact on the environment.

Performance, potential risks and whole-life costs for construction, operation and maintenance need to be identified and balanced in discussion with the client. For an overview of general technical, economic and environmental issues to be considered at the outset of design, see Chapter 2.

6.1.1.2

Definitions

Rubble mound breakwaters are structures built of quarried rock, usually protected by a cover layer of heavy armour stones or concrete armour units. The core may partly comprise other materials (eg dredged gravel). Breakwaters generally serve the purpose of providing quiet water for anchorage or mooring of vessels, protecting them from attack by waves and or currents. Other functions are also possible, as explained in Section 6.1.2. A typical cross-section of a rubble mound breakwater is shown in Figure 6.2, which indicates the various components.

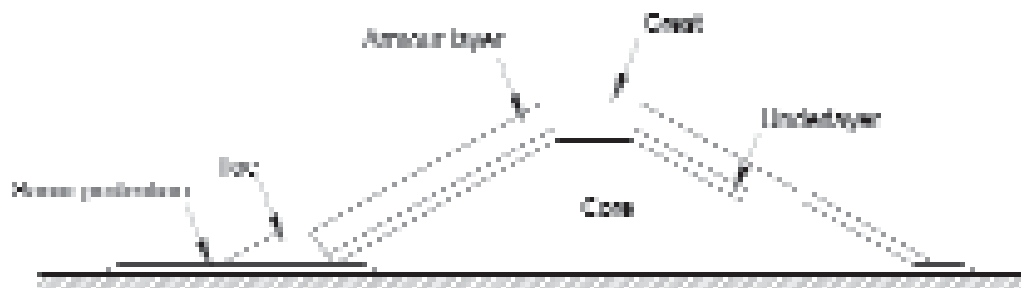

Figure 6.2 Cross-section of a typical rubble mound breakwater

From the typical section shown in Figure 6.2, various options are available depending mainly on the function of the breakwater, access, use of the lee side, crest elevation requirements and also cost considerations or repair requirements.

The main body comprises the core, usually built of wide-graded dredged or blasted material such as quarry run, one or more under- or filter layers, and the cover or armour layer. The crest may be protected by the armour layer, but frequently incorporates a concrete crest element or crown wall, often with a roadway. The toe and scour protection at the seaward face of the breakwater, when built on sandy bed material, is needed to maintain stability of the slope in case of erosion of the seabed. Depending on the type of subsoil, the breakwater may be built directly on the sea bed or on special filters, made of quarried rock and/or a geotextile. In the case of very poor foundation conditions (see Section 4.4), soil improvement or other measures may be needed to achieve geotechnical stability of the structure (see Section 5.4).

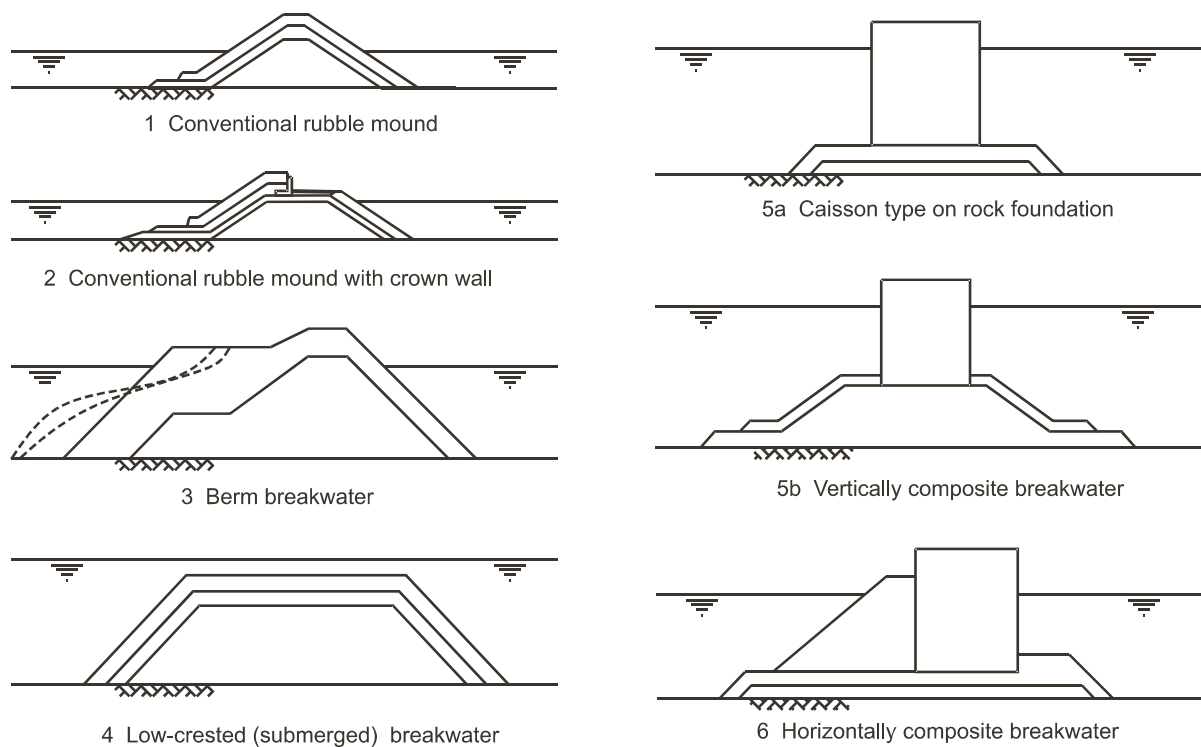

Figure 6.3 Typical cross-sections of various types of rubble mound breakwater

The following types of rubble mound breakwater will be discussed in this section (see Figure 6.3).

1 Conventional rubble mound

This commonly used form of structure has a simple trapezoidal cross-section. The armour layer may cover the crest and part of the lee slope as well as the front face. The purpose of such a simple cross-section is generally to provide shelter to other structures, such as jetties or berths.

2 Conventional rubble mound with crown wall

These structures are mainly used for port protection. The crown wall or *crest element*, which often incorporates a roadway, allows access along the breakwater. This is essential where the lee side of the breakwater is used for port operations, such as ship mooring (quay) or storage (platform). When a quay or platform is not included in the structure, the crown wall affords access to the roundhead and for maintenance of the breakwater.

3 Berm breakwater

In this case, armourstone is placed in a berm on the seaward slope. Three types of berm breakwaters exist depending of the stability level of the armourstone:

- non-reshaping statically stable breakwater, where few stones are allowed to move
- reshaped statically stable berm breakwater, where during extreme storm conditions the armourstone is redistributed by the waves to form a naturally stable profile within which the individual stones are stable
- dynamically stable reshaping berm breakwater, where during extreme storm conditions the armourstone is redistributed by the waves to form a naturally stable S-profile with the individual stones still moving up and down the slope.

4 Low-crested breakwaters

Low-crested structures may be used for protection in areas where wave conditions need to be modified but overtopping is acceptable or where horizontal visibility is a requirement, eg for aesthetic purposes. These structures generally allow significant wave overtopping and may be partially emergent above the water surface or fully submerged,

in some cases depending on the tidal state. This type of breakwater is usually constructed as a mound of armourstone sometimes covered by artificial units, which is a conventional statically stable rubble mound. An option is to construct two parallel breakwaters, the sea-side one being a submerged breakwater and the lee-side one being a low-crested breakwater, to form a double-mound breakwater. These structures generally only limit wave heights effectively for a narrow variation in water levels so they tend to be used mainly for low tidal range conditions. Low-crested breakwaters may be used as beach control structures (see Section 6.3.1.4 on detached breakwaters).

5 Caisson-type or vertically composite breakwater

This is a combination of a rubble mound with a caisson, where the caisson is placed on top of the mound. The rubble mound may only be a low-level foundation for the caisson (see 5a in Figure 6.3) or it may occupy a significant proportion of the depth (see 5b in Figure 6.3). Depending on the depth of the mound relative to the water level and waves, the mound may or may not need protection. This type of breakwater is mainly used as a port protection structure.

6 Horizontally composite breakwater

This is another combination of a rubble mound with a caisson, where the caisson is placed behind a rubble mound-type seaward protection made of armourstone or artificial units that are of sufficient size to be hydraulically stable. The caisson may be placed on top of a foundation of smaller armour stones.

A general distinction is made between attached or shore-connected breakwaters and detached breakwaters. In most cases breakwaters are connected to the shore and comprise a root at the landward end, a trunk portion and a roundhead at the seaward end. If composed of trunk portions with different orientations, an elbow is formed at the junctions. In some cases breakwaters are fully detached and therefore have two round heads, but no root.

6.1.1.3 Selection of breakwater type

Factors affecting the selection of a preferred breakwater type include cost, constructability, local availability of materials and owner preference. In some situations one alternative may be preferred over others.

Caisson breakwaters are often preferred in deeper water, as the quarried rock quantities for a rubble mound increase significantly with increasing depth. The water depth at which a caisson option becomes more economical will vary according to the location, but there is a general preference for caisson breakwaters, including vertically composite caissons placed on a rubble mound, where the water depth is 15 m or more.

Rubble mound breakwaters have better wave energy dissipation properties than vertical breakwaters and so may be preferred to reduce wave reflections. Where the available armourstone top size is not large enough to provide armour stones for a conventional trapezoidal rubble mound, then a berm breakwater solution may be selected, as the design can be tailored to match quarry yield. In areas of low tidal range low-crested or submerged breakwaters may be used.

Where the breakwater will also serve a purpose within a port such as providing a quay wall or storage area, a rubble mound structure will require a concrete crest. A caisson option may be preferred in this instance, as vessels will be able to berth alongside.

6.1.2 Plan layout

This section discusses the development of the alignment of a breakwater as part of the overall planning process of a port, harbour or marina. Further guidance on port and harbour planning and design can be found in Thoresen (2003). In this chapter, the term *harbour* is used in the sense of a sheltered area that provides refuge from wave disturbance. Harbours may be natural or, as discussed here, may be created by the construction of one or more breakwaters. The harbour may serve the purpose of, or may include, a port or marina. Figure 6.4 shows the port of IJmuiden, created at the seaward side of the sluices in the main entrance canal to Amsterdam, and protected on the seaward side by two breakwaters.



Figure 6.4 The port entrance at IJmuiden, The Netherlands (courtesy Rijkswaterstaat)

The harbour area should be designed so that:

- the least amount of wave energy penetrates into the harbour area
- wave disturbance at the berths is minimised to avoid downtime
- the approaches, entrance and inner basins are navigable.

The choice of the breakwater alignment is a major step towards fulfilling those requirements. Developing an optimum and cost-effective layout from the functional requirements often takes place in the early stage of a project, but is of the utmost importance for the final result.

The overall layout requires consideration of a range of functional requirements, such as port, harbour or marina operations, inland connections, environmental impacts and flexibility for future expansion, which are not of direct influence on the breakwater alignment. Indirectly they do have influence, because they define the shape of the harbour. The functional requirements that directly control the alignment are discussed in the following sections. The case study of Port 2000 at Le Havre is discussed in Box 6.1.

Box 6.1 Port 2000 project – Le Havre, France

The Port 2000 project (Figure 6.5) extends the port of Le Havre to provide facilities to cater for increased container vessel traffic. The extension is on the north shore of the Seine estuary and incorporates a 5 km-long breakwater parallel to the river.



Figure 6.5 Port 2000 Le Havre, France (courtesy Port du Havre)

Three principal sites were considered during the preliminary studies: the existing port at Le Havre, the Antifer terminal to the north and the Seine estuary. A public debate – the first in France on a major infrastructure project of this kind – took place throughout Normandy.

The port authorities put forward a long-term solution comprising investment outside the perimeter of the present port in the Seine estuary and a development scheme within the port (Figure 6.6), together with engineering works designed to provide environmental enhancement of the mudflats in the estuary.

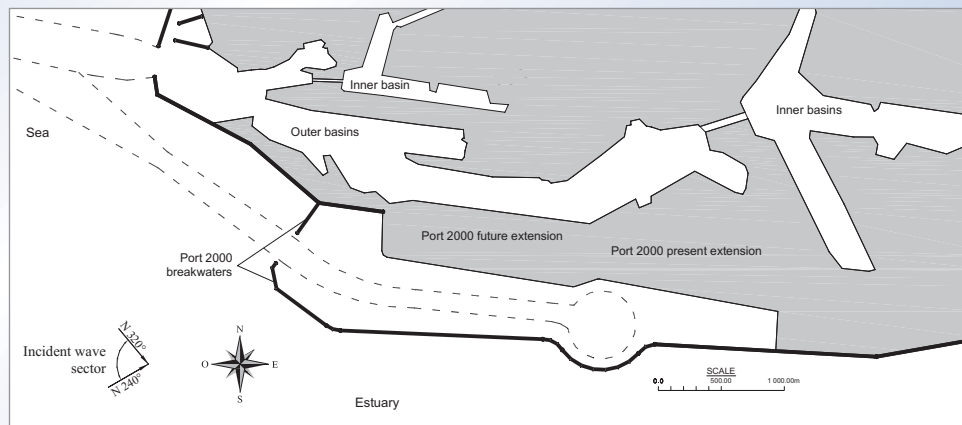

Figure 6.6 Port 2000 layout (Le Havre, France)

The main advantages of this site were:

- the possibility of building a straight quay potentially 4200 m in length, representing 12 berths, with a 500 m-wide area of adjacent port land
- the possibility of dredging a short access channel that links with the present fairway 1 km west of the present entrance channel
- hydrosedimentological impacts on the estuary were minimised.

6.1.2.1 *Influence of the need for berth protection*

Wave penetration into a harbour depends on the width of the harbour entrance and its orientation relative to the incident waves. The wave disturbance inside the harbour at a specific berth is also dependent on the degree of energy dissipation by the edges of the basins (eg by spending beaches or sloping embankments). The distance between the breakwater roundheads and their positioning relative to the breakwater trunk sections may have consequences for armour stability on the rear-side of the breakwaters and on other structures within the harbour, because of the diffraction effects of the breakwater roundheads (see also Section 4.2.4.7). Certain armouring techniques on the inner faces of breakwaters and on waterfronts of port facilities may also increase wave disturbance inside the harbour: for example, vertical walls may be preferred for berthing but can cause high wave reflections and hence increased wave agitation for vessels.

A narrow and well-orientated entrance can reduce the length of breakwater required for a given level of acceptable wave disturbance in the harbour. However, the design of the entrance also needs to take account of navigation requirements, such as the required manoeuvring space.

Numerical and physical modelling of waves and currents can be used to optimise breakwater layouts for harbours to ensure adequate protection of berths. Typical modelling techniques are discussed in Section 4.2.4.10 for wave conditions and in Section 4.2.3.4 for marine and estuarine currents. Special features of both numerical and scale modelling are discussed in Section 5.3.

6.1.2.2 *Influence of the need to provide protection to access channel*

Vessels should be able to enter and depart from the harbour safely even in adverse weather conditions. Subsequently the alignment of the breakwater and the harbour layout should be determined taking into account factors that may affect safe navigation, such as current velocity and wave disturbance. In exposed sites such criteria may have significant consequences on the design of the breakwater sections. Analysis should be undertaken for operational conditions, and also for conditions in which construction vessels will operate if waterborne construction will be undertaken.

Box 6.2 provides a case study of development of the port of Oostende, where two new breakwaters were required to improve conditions in the port access channel. Box 6.3 gives an example of the breakwaters at the entrance to the lagoon of Venezia (Venice). In this case the gates are required not only to protect the access channel but also to protect the flood control gates that protect the lagoon against surges.

Numerical and physical modelling of waves and currents can be used to optimise breakwater layouts to ensure adequate protection. Typical modelling techniques are discussed in Section 4.2.4.10 for wave conditions and Section 4.2.3.4 for marine and estuarine currents. Special features of both scale and numerical modelling techniques are discussed in Sections 5.3.2 and 5.3.3.

1

2

3

4

5

6

7

8

9

10

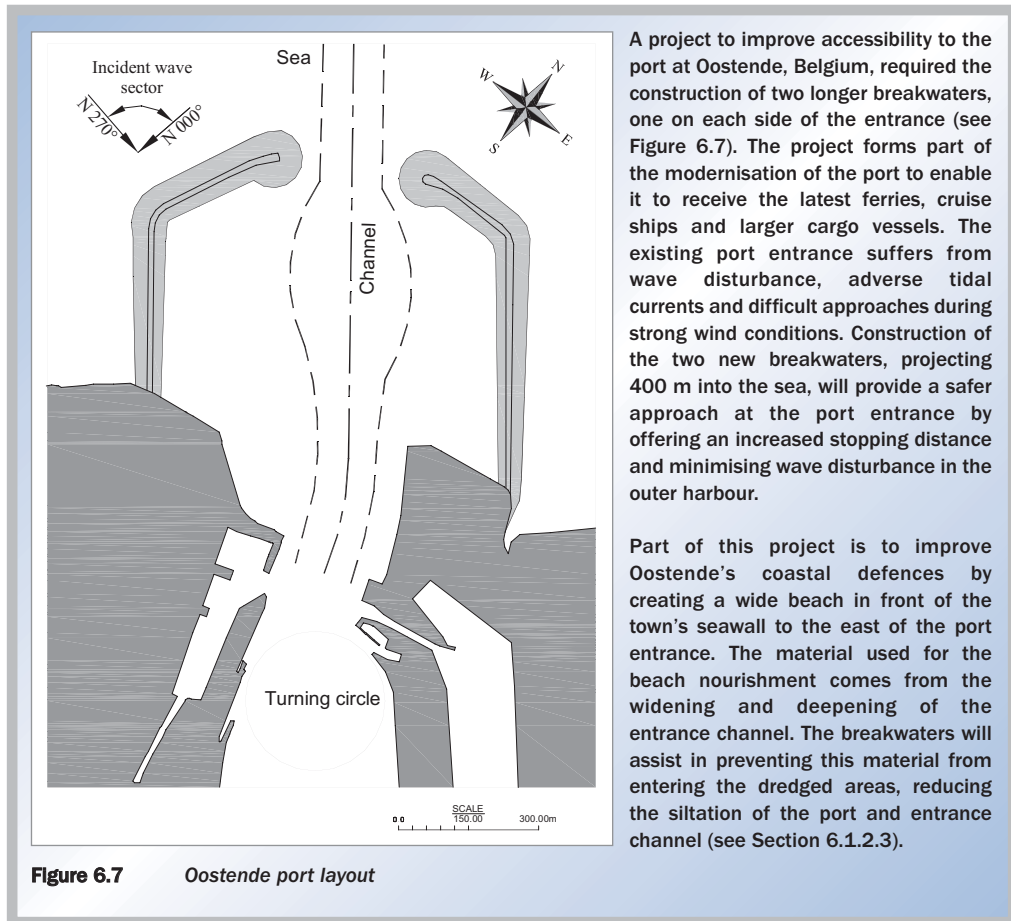
Box 6.2 Port protection improvements, Oostende, Belgium**Box 6.3** Lagoon breakwaters, Venezia, Italy

The protection of Venezia (Venice) against floods caused by surges in the Adriatic Sea will involve the construction of gates in each of the three entrances to the lagoon. Closure of these automatic floating-type gates will be triggered when the sea level rises above acceptable tidal levels. A combination of attached and detached breakwaters (see Figure 6.8) will protect the access channel through the entrances when the gates are open. During periods of high sea level, the breakwaters will protect the closed gates against heavy wave loading.

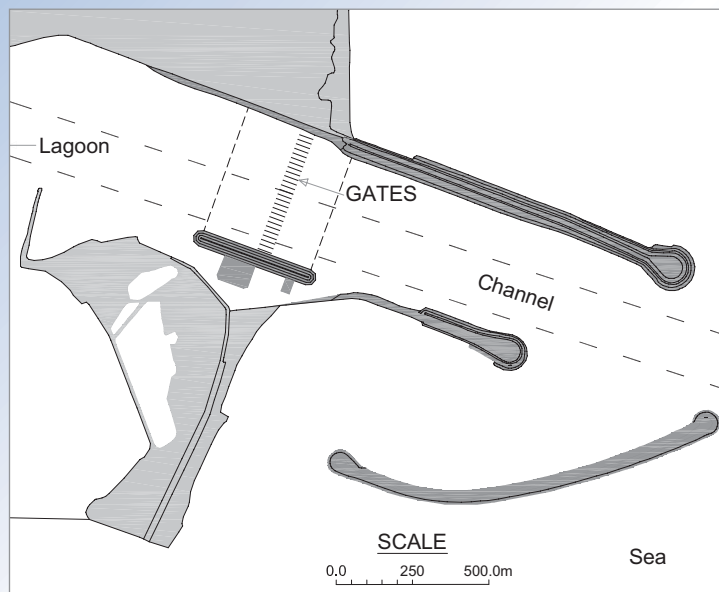

6.1.2.3 *Influence of the need to reduce maintenance and dredging costs*

For major commercial ports designed for large, deep-draught vessels, the need to protect berths and access channels is generally more significant than the need to minimise maintenance and dredging costs. However, for smaller harbours that are not built far out into the sea, siltation of the port entrance can become an important operational and economic factor. In these cases the cost of a longer breakwater may outweigh the maintenance dredging costs over the project life. This cost optimisation leads to an alignment for which the sum of breakwater construction costs and maintenance dredging costs is minimised.

The most common cause of siltation of the port entrance is littoral sediment transport; after a period of accretion against one of the breakwaters, the material starts to bypass the breakwater head and deposit in the entrance. This can be a particular problem for small ports where the breakwaters do not extend far outside the zone of littoral transport.

When the breakwater extends into deeper water, the capacity for accretion is much greater. There may be potential for sediments to be transported into deeper water and lost from the system if there is no intervention to transport accreted sediments to the downdrift side of the structure. Where a port is located in an estuary or inlet and an entrance channel is needed through a bar, construction of a breakwater may be a way to reduce siltation in the channel. In such cases siltation also occurs through the deposition of silt transported by the tidal flow, either through the channel, across it or both. Where the breakwater's key purpose is to control sedimentation it may be low-crested, but it may need to extend above high water to avoid presenting a navigation hazard.

Littoral transport and channel siltation should be analysed early in the design process; numerical models and physical models are available for this purpose (see Section 5.3).

6.1.2.4 *Effect of the layout on the breakwater sections*

The functional requirements, the harbour layout and the structure concept interact with each other. The designer may develop different layouts that meet the same functional requirements. Alternative layout options should be analysed, since the layout has a direct effect on the design of the structures. Some examples can illustrate different options;

- a detached breakwater is likely to be shorter than a shore-connected one, but the cost of the construction may be higher because waterborne equipment has to be used. However, the volume of material needed will be less because of the reduced length, and perhaps also because a lower crest level is acceptable as there is no need to have a working platform for land-based plant at a safe height above the water level. Use of waterborne equipment may not be possible if daily sea conditions are poor
- when looking for the best location for a breakwater it is advisable to study the bathymetry and also the possible shoaling near the coastline. There are examples where breakwaters are located where the waves are highest and close to breaking, which has had dramatic consequences on the size and hence cost of the armour layer
- in other cases, moving the breakwater seawards has allowed more space for accommodating splash due to wave overtopping behind the breakwater and this has significantly lowered the effects of overtopping at the limit of the working area within the harbour. This can also mean that the crest levels of the structures can be reduced
- access along the breakwater is often a functional requirement for maintenance or other operational purposes. This may be achieved with an access road at the crest of the structure, requiring a concrete structure at the crest, with associated cost. Depending on the availability of materials and the design loads for the roadway, a concrete crest may sometimes represent an economic alternative to armourstone. On the other hand it may

prove to be a more expensive option that requires additional construction operations, which in turn can affect construction sequencing and programme.

Every decision on the harbour layout should be carefully assessed and compared to alternatives. An apparently direct cost-saving, eg in material volumes, may be more expensive overall because of another factor that influences other costs, such as the required construction method or navigation safety.

6.1.2.5 **Effect of the breakwater sections on harbour layout**

The choice of type of structure may have an effect on the behaviour of the waves inside the harbour and the harbour layout may differ for different structure alternatives. For example, the wave reflections from a vertical impermeable wall are substantially higher than from a perforated caisson or an inclined porous surface of a rubble mound. The higher reflected waves may cause more downtime for activities within the harbour and the plan layout will have to be designed with this in mind. Figure 6.9 shows a breakwater with the armourstone protection extended around the end of a vertical wall to minimise wave reflections at the entrance to the harbour.

Where caisson structures are used within harbours, in many cases perforations or voids may be incorporated in the face to provide energy dissipation and improve wave conditions. The dimensions of such voids are a function of the wavelength of the incident waves, typically 15–25 per cent. They are therefore generally most practical for minimising reflections of short-period waves. Further guidance on perforated caisson behaviour is given in Oumeraci *et al* (2001). In Europe, examples include Dieppe and Porto Torres, discussed in Oumeraci *et al* (2001), and there are many examples in Japan.



Figure 6.9 *Armourstone protection on breakwater roundhead, adjacent to vertical caisson (courtesy Clive Orbell Durrant)*

6.1.2.6 **Cost considerations**

Significant cost savings can usually be made by minimising the breakwater length. It can be noted that computational or physical modelling studies are on average equivalent to the construction of 1 or 2 metres of breakwater and savings can be equivalent to the cost of several tens of metres of breakwater. Basic navigation simulations are in the same cost range.

These tools can be used to inform the design process, although it is important to note that adequate input information is required to ensure an accurate representation of conditions at the site in question.

6.1.3 Geometry of breakwater cross-section

6.1.3.1 Cross-section concept generation, selection and detailing

The selection of the type(s) of breakwater cross-sections to be examined in more detail should be made on the basis of:

- functional requirements, discussed in relation to plan layout in Section 6.1.2
- boundary conditions, see Section 6.1.3.2 (and Chapter 4)
- materials availability, see Section 6.1.3.3 (and Chapter 3)
- construction considerations, see Section 6.1.9 (and Chapter 9)
- future maintenance requirements, see Section 6.1.10 (and Chapter 10).

If this selection still permits alternative designs to be considered, the final choice should then be made on the basis of optimisation using cost comparison and consideration of appropriate construction methods (see Sections 6.1.8 and 6.1.9; Sections 9.3 and 9.7; Sections 3.2 and 3.11, as well as Section 2.4). This process is illustrated in Figure 6.10.

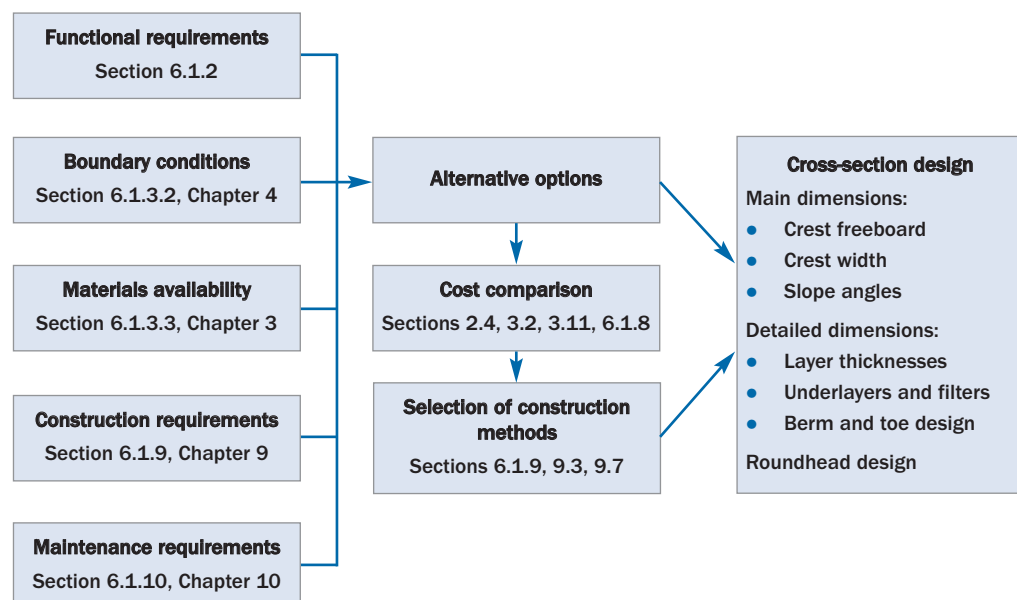

Figure 6.10 Cross-section selection

Significant cost savings arise when the height of the breakwater is reduced. By assessing material availability and boundary conditions it can be seen whether there is a need to use concrete armour units for the primary armour, if armourstone of sufficient size is not available.

For the selected option/s, the required values of the main dimensions (crest height, size and thickness of primary armour and underlayers etc) should first be determined by using the structure-specific hydraulic and geotechnical design tools presented in Sections 5.2 and 5.4. Actual dimensions and practical details should be obtained from the structure-specific considerations and rules of thumb given in Sections 6.1.4 to 6.1.7, including constructability, availability of armourstone of various gradings and the possible or preferred level of maintenance.

The information in Sections 6.1.4 to 6.1.7 is really only adequate for preliminary design purposes, so the detailed design for major breakwater projects should ideally be checked in a hydraulic physical model (see Section 5.3.2), making use of state-of-the-art techniques. Alternatively, uncertainties in the design formulae may be translated into (increased) safety factors, but even for small breakwaters this generally leads to substantial cost increases. In most cases model tests are cost-effective and lead to optimisation of the preliminary design.

6.1.3.2 **Data collection and boundary conditions**

The main environmental conditions serving as input parameters for the design formulae and mathematical or physical models are given in Table 6.1 below.

Table 6.1 *Main environmental input parameters for design formulae and models*

Input parameters		Output	Tools
Environmental conditions	Water depth, tides and currents, long-term wave statistics	Design water levels, currents and wave statistics at the structure	Section 4.2.2: Marine water levels Section 4.2.3: Marine and estuarine currents Section 4.2.4: Wind waves and swell
	Seabed properties, bathymetry	Bearing capacity, geometry of the structure	Section 4.1.2: Bathymetry and morphology related to marine structures Section 4.4: Geotechnical investigations and data collection
Conditions during construction	Short-term wave statistics and seasonal variation, meteorological conditions	Construction methods and cost Design elevations	Section 4.2.4.8: Short-term or daily wave climate Section 9.3: Equipment
Environmental restrictions	Availability of construction material, infrastructure facilities Presence of protected fauna or flora	Construction costs Mitigation measures	Sections 3.2–3.11: Quarried rock Section 9.4: Transport
Present constraints	Availability of labour and equipment, local experience, safety of labour and public	Production costs and works duration	Sections 3.2–3.11: Quarried rock Section 9.5.2: Key hazards sources and their delivery
Future constraints	Facilities for future maintenance Durability of construction materials	Design details	Section 2.4.6: Maintenance and repair Section 2.4.7: Removal Chapter 10: Repair and replacement

6.1.3.3 **Materials availability**

The material for rock structures is supplied by quarries (see Section 3.9), the geological characteristics of which determine the maximum size and shape of the armour stones. Where a quarry is dedicated to a breakwater project, blasting to obtain the required design sizes of armourstone for a conventional rubble mound breakwater usually involves production of greater quantities of materials than are required by the design. This often results in an overproduction of certain gradations for which normally no other application can be found, even when that required for concrete aggregates has been used. This material is then effectively classified as waste. The design of a rock structure in this situation should therefore be tailored to the expected quarry yield as much as possible. This practice has been successfully adopted in Iceland and Norway.

Use of concrete armour units (see Sections 3.12 and 6.14) and berm breakwaters (see Section 6.1.6) are examples of design approaches that help achieve this kind of tailoring. Information

on assessing quarry output and on production techniques in the quarry is given in Section 3.9. Berm breakwaters can make use of the total quarry output. Cost implications related to the use of the quarry output are discussed in Section 6.1.8. Concrete armour units make use of materials with a mass of less than 1 kg that may be processed to produce aggregate for fabrication of the concrete units. This material is generally inexpensive compared with selected armourstone and is often a surplus material if only large stones are required from the quarry output. If proper filter layers are used this small material may only be suitable for use in the core (see Section 5.2.2.10 and Section 5.4.3.6).

Armourstone is often obtained from permanent quarries (see Section 3.9). The majority of these quarries provide smaller sized aggregates and therefore blast for maximum fragmentation, so that large armourstone is essentially a by-product. Some permanent quarries may adjust their blasting procedures using fragmentation techniques described in Section 3.9 to maximise armourstone production and minimise damage to large stones.

When the quarry output is such that the use of artificial units is the most economical option, the designer should check the availability, cost of supply and quality of cement for the duration of the works. It is recommended that this alternative be evaluated as soon as possible and certainly before comprehensive design or model testing are carried out on the cross-sections.

In addition to the top size of armourstone available, it is important to assess the quality of available rock sources. If locally available rock is not of sufficient quality, then it may be necessary to oversize the armourstone to account for degradation over the project lifetime. Alternatively, armourstone may need to be imported from another source, which will affect the project cost. Use of lower-quality rock may also have implications for maintenance requirements during the project life. There is more discussion of rock durability issues in Section 3.6. Maintenance issues are discussed in Section 10.5.

6.1.3.4 **Failure analysis**

The design of a breakwater requires hydraulic, structural and geotechnical analysis. This should cover all identified failure modes. Failure mechanisms are summarised in Section 2.3.1. The more frequent failure modes that are particularly relevant to rubble mound and caisson breakwaters are shown in Figures 6.11 and 6.12, respectively.

Failure may be defined in terms of exceedance of **serviceability** or **ultimate limit states**. The **Serviceability Limit State (SLS)** refers to performance of the structure under normal conditions, and generally defines the function the structure is required to perform: for example, a breakwater may be required to provide a certain level of protection to limit wave conditions in a harbour to an acceptable level. While exceedance of the SLS may not lead to damage or failure of the breakwater it will mean it is not performing the required function.

The **Ultimate Limit State (ULS)** refers to performance under extreme conditions, and generally defines the ability of the structure to survive under extreme loading conditions. Exceedance of the ULS leads to damage, and potentially failure, of the structure: for example, exceedance of design wave conditions may lead to damage of breakwater armour and underlayers, with risk of progressive failure.

Rubble mound breakwaters

For rubble mound breakwaters, failures are generally caused either by wave action or by geotechnical factors, such as slope failure, foundation failure and internal erosion, which are influenced by dead weight, sub-surface water loads and seismic actions. Toe erosion, slope failure, internal erosion, hydraulic damage and severe overtopping, which can cause erosion of the crest and lee-side damage, are key causes of major damage (see Figure 6.11). Checks should be undertaken for each of these potential failure modes. Physical model testing is of

utmost importance for assessing the behaviour of the structure against wave action. Foundation erosion and related slope failure at the toe of the structure is a common failure case that should be carefully assessed.

Apart from these so-called 2D failure modes (which can be verified in a wave flume), 3D effects are of equal importance, in particular:

- lee-side parts of roundheads
- transitions, junctions and terminations, such as at crown walls, caissons, toes etc (see Figures 6.16, 6.20 and 6.32): these are prime locations for initiation of damage.

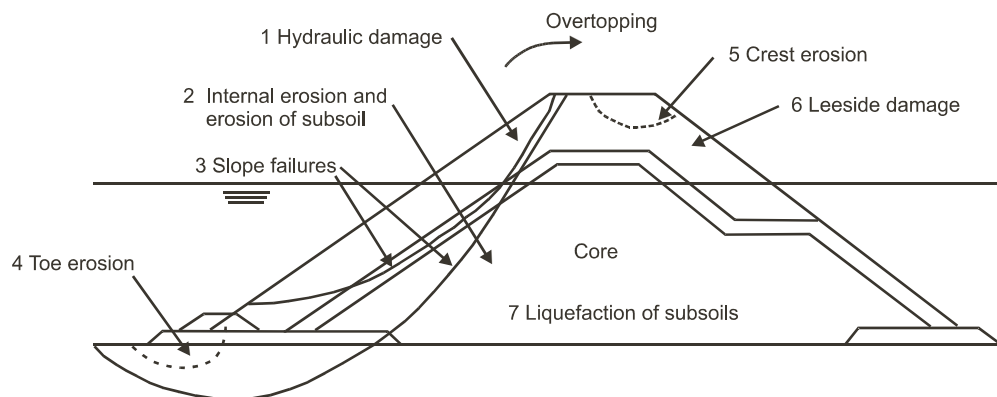

Figure 6.11 Standard rubble mound breakwater failure modes

Caisson breakwaters

Failures have been experienced by vertically composite breakwaters because of the very high impact forces caused by breaking waves, which can lead to instability of the caisson structure on its rubble base. Literature is available for calculation of the loads on caisson structures and assessment of stability (Goda, 2000; Miyata *et al*, 2003). If conditions at a specific location are such that breaking waves can occur, a horizontally composite breakwater may be a viable alternative. Initially, the concept was developed in Japan to protect existing caisson-type breakwaters against (further) damage. At present it is still applied at sites where quarried rock is scarce and breaking waves cannot be excluded. Further discussion and new guidance for the design of caisson breakwaters including assessment of breaking wave forces is provided in the report of the EU project on PRObabilistic design tools for VERTICAL BreakwaterS (PROVERBS); see Oumeraci *et al* (2001).

Instability of the rock berm and foundation and toe erosion can be caused by wave action and are discussed in this manual (see Section 5.2.2.9). Calculation of the caisson stability and related planar or circular slip failure are not part of this manual, although the effect of the caisson on stability of the rubble base, notably with reference to its effect on pore pressures, is discussed in Section 5.4.5. The main failure modes for vertically composite caisson structures are shown in Figure 6.12.

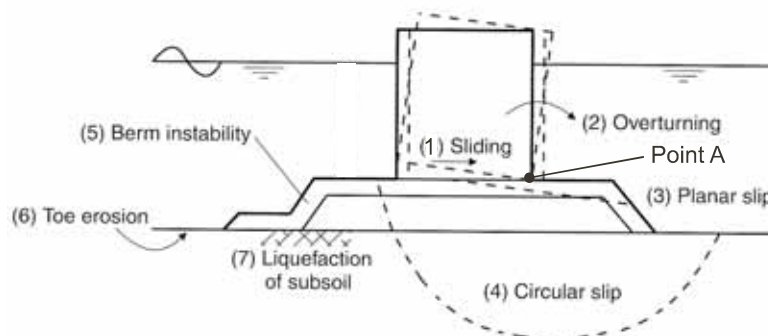

Figure 6.12 Failure mechanisms of a caisson breakwater

6.1.4 Conventional rubble mound

Once the layout of the harbour has been chosen, the determination of the size and layout of the components of the cross-section is a principal design objective. The selection of design conditions, accepted damage levels and maintenance policy allows the armour criteria to be calculated using design equations for armour layer stability given in Section 5.2.2.2 for armourstone on non-overtopped structures, Section 5.2.2.3 for concrete armour layers and Section 5.2.2.4 for armourstone on low-crested (and submerged) structures. The main dimensions of the cross-section can then be estimated. Each typical cross-section applies along a length of the whole structure. Different cross-sections need to be developed if seabed levels and exposure to waves vary significantly along the length of the structure. The wave climate and bathymetry along the full length of the breakwater need to be known. The bathymetry should be surveyed for a distance of at least several wavelengths in front of the structure, as seabed features may cause localised wave energy concentrations (see Section 4.2.4.7).

When the main dimensions have been settled, the budget cost of the structure can be calculated. This can be used to make a comparison between the different project options. Once the preferred option is selected, the next step is to define the roundhead and the design details of the structure.

6.1.4.1 Main dimensions

A definition sketch for a conventional rubble mound breakwater is shown in Figure 6.13. The structure typically consists of a core of quarry run (and possibly some alternative materials such as dredged gravel or secondary materials) (see Section 3.4.4) protected by armour on the seaward slope, on the crest and on (part of) the lee-side slope. A filter or underlayer is generally needed between the core and armour, depending on the filter requirements (see Sections 5.2.2.10 and 5.4.3.6) and the need to protect the core against wave attack during construction. A filter layer may also be required between the structure and the sea bed. A toe is often built to support the armour layer. Scour protection may also be provided seaward (and landward of the toe) to prevent scour of the adjacent sea bed, which could affect breakwater stability.

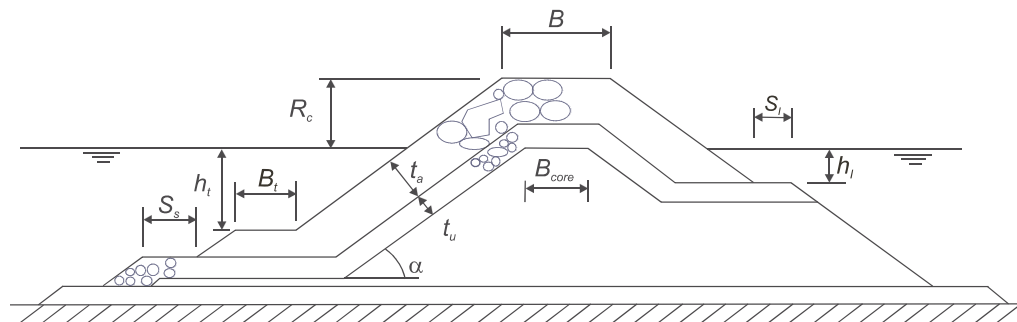

Figure 6.13 Definition sketch for a rubble mound breakwater

The parameters defined in Figure 6.13 are as follows:

- crest freeboard, R_c (m)
- crest width, B (m)
- slope angle, α (deg)
- armour layer thickness, t_a (m)
- underlayer thickness, t_u (m)
- seaward toe level, h_t (m)
- leeward berm or shoulder level, h_l (m)
- toe width, B_t (m)
- shoulder width, S_s , S_l (m).

These are discussed in more detail within this section and in Section 6.1.4.2.

Crest freeboard, R_c

The elevation of the crest is generally dictated by acceptable overtopping discharge or wave transmission, based on the functional requirements that have been determined for the structure and the facilities in its lee. In some situations, the structure's visual appearance may also be an issue. The minimum crest freeboard, R_c (m), follows from overtopping requirements for stability, operability and safety (see Section 5.1.1.3). Conventional rubble mound breakwaters without crown walls are not accessible to the public or vehicles. Acceptable overtopping thresholds are in that case only governed by permissible disturbance inside the harbour (see Section 5.1.1.4) and stability criteria for crest and rear face armouring (see Section 5.2.2.11). Appropriate overtopping thresholds for these criteria are given in Table 5.4 in Section 5.1.1.3. In the case that a breakwater has to be accessible, additional, sometimes more restrictive, thresholds are applicable. Assessing the crest level is a major design issue; the slope angle (see Figure 6.13) and the type of armouring of the seaward face not only determine the degree of overtopping, but also the stability of the armour layer. See also the special note as annex to Box 5.4 in Section 5.1.1.3 "Considerations related to overtopping calculations".

The crest elevation may also be determined by the level of the core relative to the water level if the structure is to be constructed with land-based equipment. This normally requires a level of at least 1 m above high water. When marine equipment is employed, the level of the crest can be chosen arbitrarily, recognising that all material above 3 m below low water level cannot be simply dumped and therefore needs to be placed by crane barges.

The crest freeboard when concrete armour units are used is governed by the same parameters as applicable to rock armour layers. Single-layer units require less layer thickness, thus allowing a higher core level and a wider core crest for easier working.

The design crest elevation should allow for post-construction settlement (see Section 5.4) and a rise of the mean sea level due to climate change (see Section 4.2).

The freeboard may occasionally be referred as the armour freeboard, R_{ca} , particularly when a crown wall is present (see Section 5.2.2.12). R_{ca} is the distance from the water level to the top of the armourstone.

Crest width, B

The crest width, B (m), should be sufficient to permit at least three stones or artificial units to be placed on the crest. This is a particularly important requirement if significant overtopping is expected to occur. In the case of armourstone, a crest width of three to four stones is typically a minimum value. The stones on the crest should be placed with maximum interlocking or packing density to ensure the greatest stability under wave action. The packing density on the crest may be different from that achieved on the slope (see Section 3.5.1 for discussion of stone packing and packing density). With artificial units a crest width with a minimum of three rows is recommended for safe placement and interlocking of the blocks. In both cases, the actual crest width also depends on the core crest width B_{core} (m). If the core is built out with dump trucks, B_{core} should allow traffic of two trucks or one truck and one crane, as illustrated in Figure 6.14. Dimensions of the trucks are governed by the volume of material to be placed in the core, the dimensions of the crane are governed by the mass of and the reach for placing the heaviest armourstone (see Sections 9.3.2 to 9.3.6). For this purpose the crest width, B_{core} , is measured at least 1 m above high water level and in exposed conditions 2–3 m above MHW is preferable.

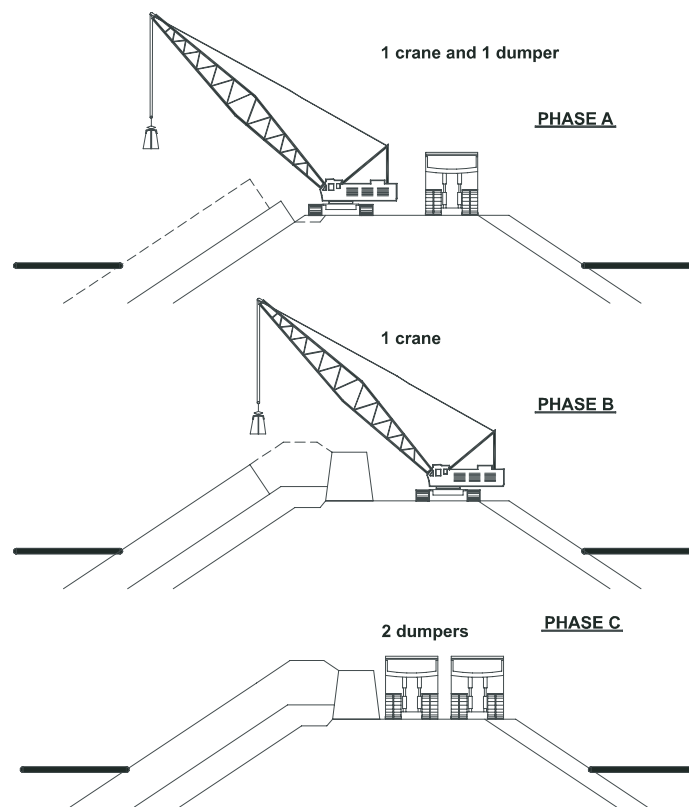

Figure 6.14 Crest width – use of land-based equipment

Slope angle, α

The slope angle, α (deg), adopted in design of the front face should ideally be as steep as possible to minimise the volume of the structure, but it depends on hydraulic and geotechnical stability considerations. The slope is generally not steeper than 1:1.5, except for artificial armour units where the preferred slope is generally given in guidance by the unit developer, and can be as steep as 1:1.33. This slope may be compared to the natural angle of repose of material dumped under water (see Section 5.4.4.2), which can be as steep as 1:1.2. An adjustment to the final required profile can be made in the secondary armour layer or underlayer, but this requires a layer thickness larger than that theoretically required and per unit volume these stones are often the most expensive (see Section 6.1.3.3). For artificial armour units, massive and bulky double-layer units are placed at slopes of 1:2.5 to 1:1.5, and highly interlocking single-layer units are preferably placed at a 1:1.5 slope and up to 1:1.33 slope. Milder slopes are acceptable, but for highly interlocking units there is no reduction in the unit mass required for stability on less steep slopes. Tolerances can vary depending on the unit, but should remain in the range of $D/5$, D being the characteristic armour unit length. The lee-side slope is generally built as steep as possible, but seldom steeper than 1:1.33.

If seismic activity is to be taken into account, the slopes should generally be gentle, to allow for the expected horizontal accelerations to be absorbed without damage (see Section 5.4.3.5). Foundation stability problems may also be encountered in locations with poor sub-soils, and in such cases gentle slopes should be used.

Roundhead design

The seaward end of a shore-connected rubble mound breakwater, or both ends of an offshore breakwater, is termed the roundhead and is circular in plan. Roundheads experience severe exposure to storms from both diffracted waves and overtopping discharges and therefore need special consideration when the armour unit size is being selected. A typical roundhead layout is shown in Figure 6.15 below.

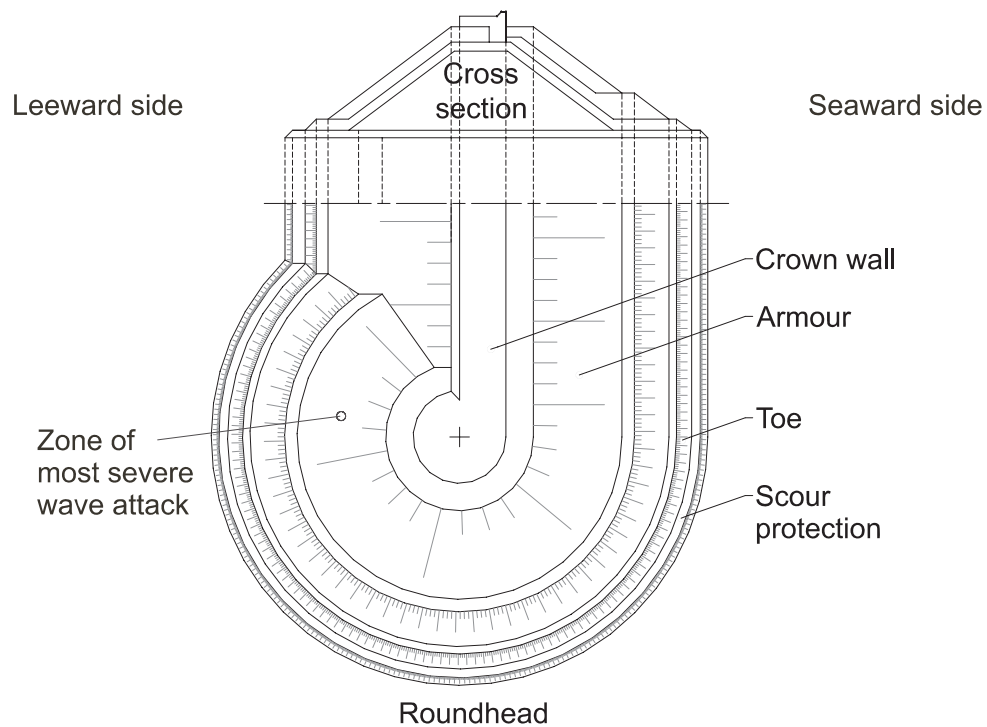

Figure 6.15 Typical roundhead layout

The main parameters of a roundhead are the radius and the side slope. The radius of a roundhead should be selected as a function of significant wave height, H_s (m), at the design (still) water level. The most severe attack is at the leeward far end quarter of the circle and the primary armour should be extended at least to this section (see Figure 6.15). If overtopping is allowed, some concentration of energy may be found at this location and hydraulic testing is recommended to confirm performance. Section 5.2.2.13 provides guidance on the design of roundheads. For a given slope, the required armour size for a roundhead will normally be greater than for the adjacent trunk section.

When sufficiently large armour stones are not available, the slope at the roundhead should be less steep than that of the trunk section to ensure stability. Care is then required to avoid reducing the width of the access channel and exceeding the reach of the crane that will be used for construction. High-density armourstone (see Section 3.5) has sometimes been used at heads, avoiding the need for either larger armourstone or milder slopes to ensure stability. An alternative is to use concrete armour units (see Section 3.12).

A reduced crest level at the roundhead allows more energy to be dissipated by overtopping rather than impacting on the structure. This can allow development of an economic design as it reduces material volumes and the required size of armour stones. Such a design refinement needs to be checked by hydraulic physical model tests. Some overtopping can often be easily tolerated near harbour entrances.

In areas where sufficient stone sizes are not available for the protection of a roundhead structure or in ports where safety regulations or local practices impose the need for a vertical reference for navigation it is possible to use caisson or mass concrete structures as roundheads, as illustrated in Figures 6.16 and 6.17. Figure 6.16 shows one of the breakwaters at the Port 2000 entrance where Le Havre Port Authority used caissons at the end of the rubble mound breakwaters to create vertical walls at the harbour entrance that provide a clear visual marker for the port entrance. Figure 6.17 shows the plan layout of the Saba harbour in the Caribbean. The original main breakwater was destroyed by a hurricane. The severe wave conditions and the constraints of the local construction facilities resulted in a design of the new breakwater with a solid concrete roundhead instead of a standard rubble

mound roundhead. Careful preparation and levelling of the stone foundation is required where caissons are to be precast and floated into position.

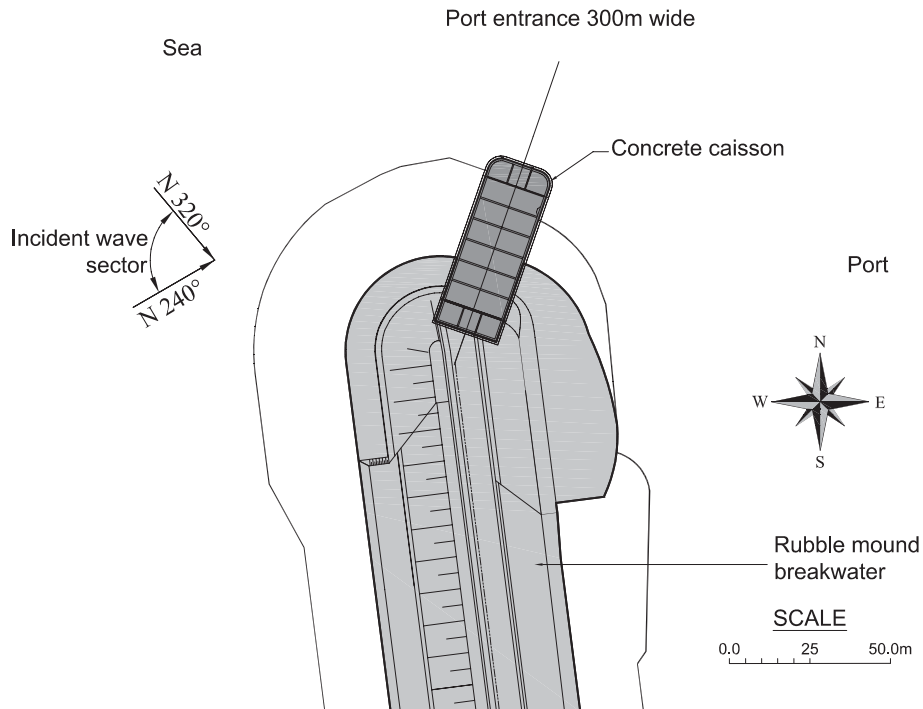

Figure 6.16 Port 2000 southern breakwater roundhead, Le Havre, France

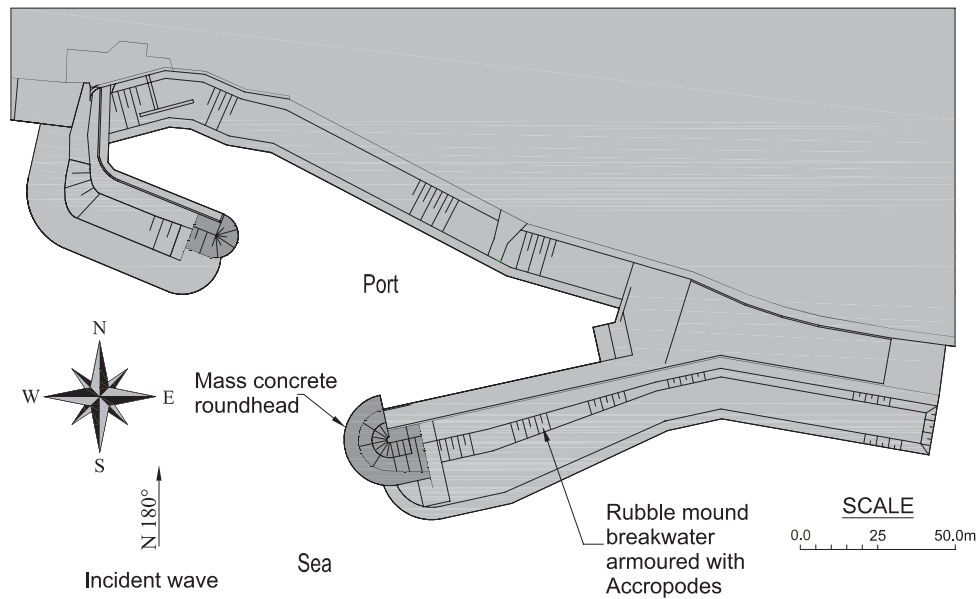

Figure 6.17 Breakwaters with mass concrete roundheads, Saba, Netherlands Antilles

When designing roundheads, consideration may also have to be given to whether the breakwater is likely to be extended in the future. Dismantling and removal of heavy stones, and in particular highly interlocking units, for future modifications to be carried out is not a straightforward task.

The transition between the trunk section and the roundhead is specific and careful attention should be paid to its design. The transition may display a change of armouring size and type on both the seaward and the lee side. Transitions are discussed further in Section 6.1.4.3.

6.1.4.2 Detailed dimensions

Having determined the main dimensions of the breakwater, ensuring an adequately low risk of failure, the following practical considerations that refer to the dimensions shown in Figure 6.13 should also be incorporated in the design.

Layer thicknesses, t_a , t_u

Having determined the armour size using the equations in Section 5.2.2.2, the layer thicknesses (armour: t_a , underlayer: t_u) follow from the requirement that for randomly placed stones a double layer is required to ensure that the inner layers are properly protected at all places even after occasional washing out of individual stones. The layer thickness is thus equal to $2k_l D_{n50}$ where k_l (-) is the layer coefficient which takes account of the layer-packing density (see Section 3.5.1 and Box 3.7). Layer thickness coefficients for artificial armour units are given by the developer; the layer thickness is determined by $nk_l D_n$, where $D_n = k_s^{1/3} D$, where D is the characteristic dimension of the unit and k_s is the shape coefficient (see Section 3.12).

Toe levels, h_t , h_l

The water depth at the toe on the seaside, h_t , is generally at least $1H_s$ to $1.5H_s$ below low water and influences the required stone size for the toe, as discussed in Section 5.2.2.9. The water depth at the lee-side toe, h_l , depends on the wave attack from inside and the amount of overtopping. As a rule of thumb, a depth of 3 m can be considered as acceptable in most cases. The effect of overtopping on the lee-side toe can only be assessed in hydraulic model tests. In the determination of h_t and h_l , the expected quarry output should also be considered, to ensure the required volumes match the quarry yield curve as closely as possible (see Section 6.1.3.3). Considering the stability formulae in Section 5.2.2.9 it can be noted that a minor increase in h_t or h_l values has a significant influence on the size of the toe armour, resulting in a requirement for smaller armourstone as the depth over the toe increases.

Toe width, B_t

For rubble mound breakwaters, the toe width, B_t (m), should in general allow at least three stones to be placed (see Section 5.2.2.9 for the determination of the stone size). The thickness of the toe berm should be based on the general requirements for layer thickness, discussed above.

A wider toe can be applied for breakwaters in zones at risk of severe scour; to provide sufficient rubble to act as a falling apron. Further measures for protection against scour are discussed at the end of this section, where recommendations for the shoulder width (of the scour protection) are presented.

Toe details

In situations with relatively deep water and a sandy sea bed it is often possible to use a smaller stone size in the breakwater toe to support the main armour layer: the configuration shown in Figure 6.18a and discussed in Section 5.2.2.9. This also applies to very deep water conditions, although in this case it is usually not necessary to cover the entire breakwater slope with main armour layer material and the toe can therefore be placed at a level above the sea bed (see Figure 6.18c).

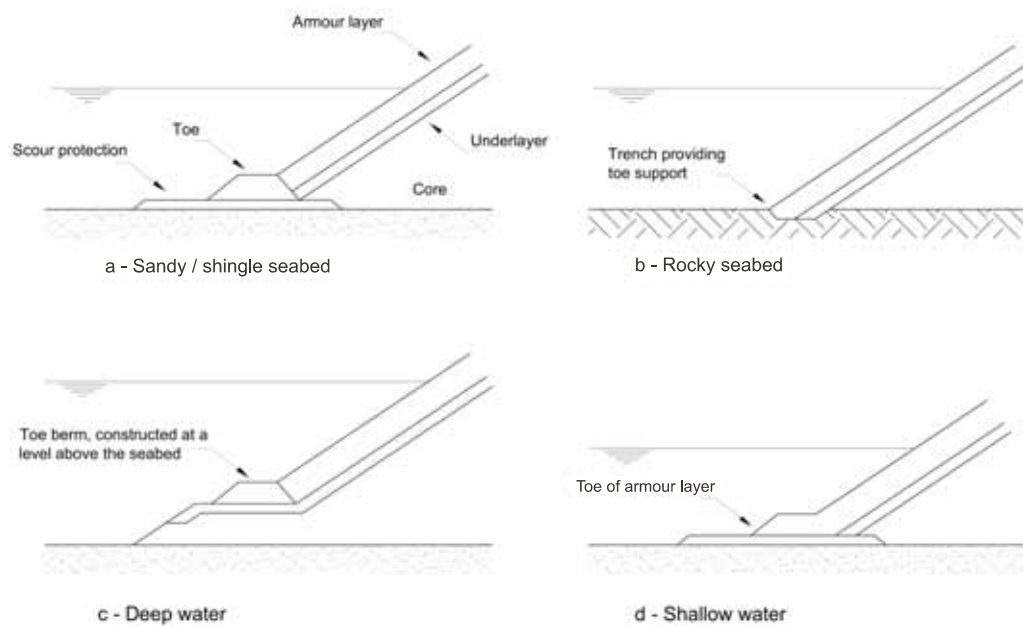

Figure 6.18 Schematic examples of toe details for rubble mound breakwaters

In shallower water the required armourstone size for the toe increases, as discussed in Section 5.2.2.9. For shallow-water conditions where waves may break on the structure, the breakwater toe can often be made by extending the main armour layer, as illustrated in Figure 6.18d. A more expensive solution for shallow water conditions is to construct the toe in a dredged trench, which makes it possible to lower the toe level and use a smaller stone size.

A more complex situation arises for shallow waters in combination with steep foreshores (for example 1:10 or steeper and at the edge of canyons), where the waves may break directly on to the breakwater toe. For these situations, toe detailing issues are often addressed by moving the position of the breakwater to more shallow water or on to the foreshore slope where there is no breaking.

Sloping rock foreshores with smooth surfaces provide limited sliding resistance for breakwater toes. For these situations toe support can be achieved by digging a trench (see Figure 6.18b) or by supporting the toe armour with piles driven into the rock (see Box 6.4).

- **Toes of concrete armour layers**

The toe details for concrete armour units do not differ significantly from those for natural armourstone, but they are specific for each concrete armour unit and details should be provided by the product developer. Attention should be given to the construction scenario. Placement along a grid at the toe is always possible, but placement in a given orientation may require the assistance of divers and should be restricted to limited depths or locations where the working conditions are satisfactory. The toe stability is essential for the whole armour layer stability. Examples of some toe details of concrete armour layers are given in Figure 6.19.

An important **feature of highly interlocking single-layer armour units** is that the armour layer is much more stable at the centre than at the edges and especially at the toe. When such a toe is in shallow water conditions with aggressive plunging waves, little can be done to protect the edges of the armour layer. The solution is to place the first row in an excavated trench in the rocky sea bed, as shown in the embedded toe detail in Figure 6.19, or to create special stabilising solutions, such as are discussed in the case study in Box 6.4.

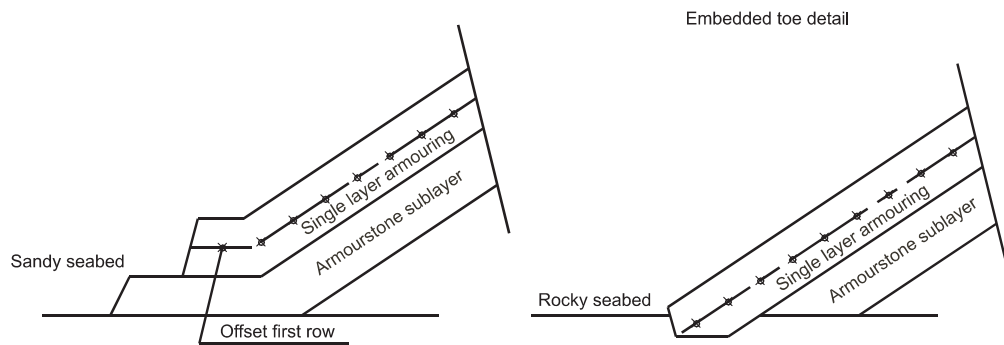

Figure 6.19 Toe details for single-layer concrete armour units

Shoulder width, S_s , S_l

Unless specific erosion conditions are encountered, the shoulder width at the sea side, S_s (m), is mainly determined by placing tolerances and is generally not less than $S_s = 2$ m. The corresponding width, S_l (m), at the lee side is determined by tolerances; $S_l = 0.5t_u$ (underlayer thickness) is a practical value. If scour problems are expected, the shoulder becomes an erosion control device and the extent of the shoulder should not be less than 6 m or H_s from the toe of the structure. This design detail is the same for concrete armour units as armour layer material.

Box 6.4 Case studies of special toe design for concrete armour units

Piled toe

A concrete armoured structure was constructed to improve overtopping conditions. The toe of the structure is on a very shallow rocky seabed. The traditional method of anchoring the toe would have been to dig a trench and to bury the first row of armour units in this trench or to secure the toe with concrete cubes anchored into the sea bed. All solutions were tested in a laboratory. An alternative to the toe cube blocks was implemented that consisted of precast concrete piles. The concrete piles are composed of H-profiles cast into 800 mm circular concrete piles (see Figure 6.20).



Figure 6.20 View of the model test for typical toe detail using concrete piles (courtesy HR Wallingford)

Box 6.4 Case studies of special toe design for concrete armour units (contd)**Anchored concrete toe blocks (for Cirkewwa breakwater)**

The root-end section of the Cirkewwa breakwater, Malta, is founded on a very shallow rocky seabed. The wave attack on the structure is very oblique. Model tests have shown that the only way to secure the toe was to construct anchored concrete cubes of about 60 per cent the height of the Accropode armour units, as shown on the typical section in Figure 6.21.

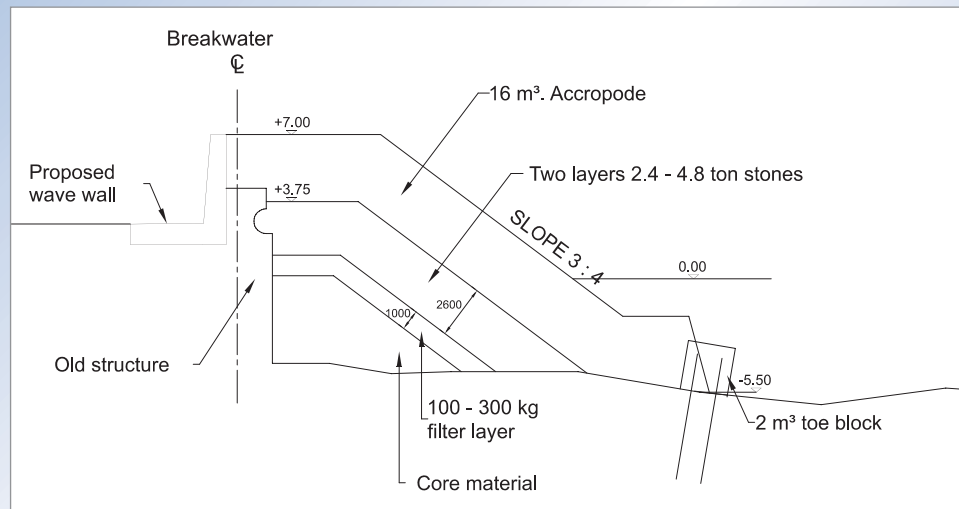

Figure 6.21 Cirkewwa: typical toe arrangements

6.1.4.3 Transitions

Transitions in rubble mound breakwaters are required in the following cases:

- when the orientation of the breakwater changes relatively rapidly
- between different types of armouring
- between different sizes of armouring.

Transitions in concrete armour unit structures are generally more complex than for armourstone structures as these units are often placed to a specific placing pattern, which is essential to ensure good interlock. Thus some specific issues for transitions in concrete armour unit structures are discussed first and illustrated in Figure 6.22, followed by guidance for armourstone structures.

The external profile at transitions should preferably be kept constant, although it should be noted that this then involves a change in profile of the underlayer, filters and core profiles. Where changes in the external profile are necessary, these should be as gradual as possible. Any protrusion or *overhang* of larger concrete units or armourstone at a transition across the slope of the breakwater should be avoided as hydraulic loads can lead to extraction of such units and progressive damage of the armour layer.

NOTE: Transitions are zones of weakness in a structure and it is recommended that physical modelling of any design should include transitions to ensure that they are not located in zones of localised increases in hydraulic loading. The model should also accurately represent the form of the transition, the placing techniques and the packing density of the concrete units or armourstone.

Changes in orientation in concrete armour unit structures

Transitions in breakwater orientation in plan with no change in concrete armour unit size may be constructed by placing the straight sections to the standard placing pattern,

terminating these at an angle of approximately 45° across the side slope (see Figure 6.22a). The armour units are then placed around the bend or transition area, leaving a triangular panel between the two sections that is then filled, working from toe to crest, ensuring good interlock with the units that are already placed. Often this is executed in a series of smaller triangular panels until the transition is complete. The units should be placed in accordance with any specific placing instructions applicable to the relevant type of concrete armour unit.

Transitions may also be required at relatively sharp bends (*knuckles*), often using heavier concrete armour units in these zones than in the adjoining straight sections as stability can be less due to 3D effects and reduced friction between the individual units (similar to the stability-reducing effects found at roundheads). Such transitions are generally completed in the same manner as above, ensuring that the smaller (trunk) units are placed on top of the larger units at the interface between the two sizes (see Figure 6.22b).

Changes in type of armouring

Special transitions are also necessary in breakwaters between different types of armouring, ie between sections with concrete armour units and sections with armourstone as cover layer. Note that different types of concrete armour units are normally not applied to the same structure. Such transitions are therefore not discussed here. A typical location for transitions between armourstone and concrete armour units is the area behind the roundhead of a breakwater. The concrete armour units (eg on the roundhead section) should be placed first, resulting in a transition line at 45° across the side slopes (as described above), after which the armour stones are placed on top of and against the concrete armour units (see Figure 6.22c). This also means that the type of armouring with greater stability should be placed first. The transition between the different underlayers requires special attention as the internal level differences may be significant, due to the different armour and underlayer thicknesses, assuming that the external profile is kept constant (which is preferred – see above).

Changes in concrete armour unit size on trunk sections

Transitions are also necessary along breakwater trunk sections between different sizes of the same type of concrete armour unit. For transitions between different sizes of armouring the smallest elements should always be placed on top of the larger ones (see Figure 6.22d).

Transitions in armourstone structures

Transitions between sizes in armourstone structures may be either inclined transitions across the slope as described for concrete armour units (see Figure 6.22d) or alternatively steeper (often near-vertical) transitions may sometimes be used. The form of the transition is often dictated by practical factors such as the construction plant to be used, whether different cranes are needed for placing different sizes and the reach of the cranes being used. As noted above, any changes in external profile should be as gradual as possible.

The sequence described above for construction of transitions at changes in orientation is less applicable to armourstone structures as there is greater flexibility in placing armourstone, compared with units that require to be placed to a predefined pattern. The sequence of constructing such planshape transitions in armourstone structures is therefore more likely to be defined by construction methodology.

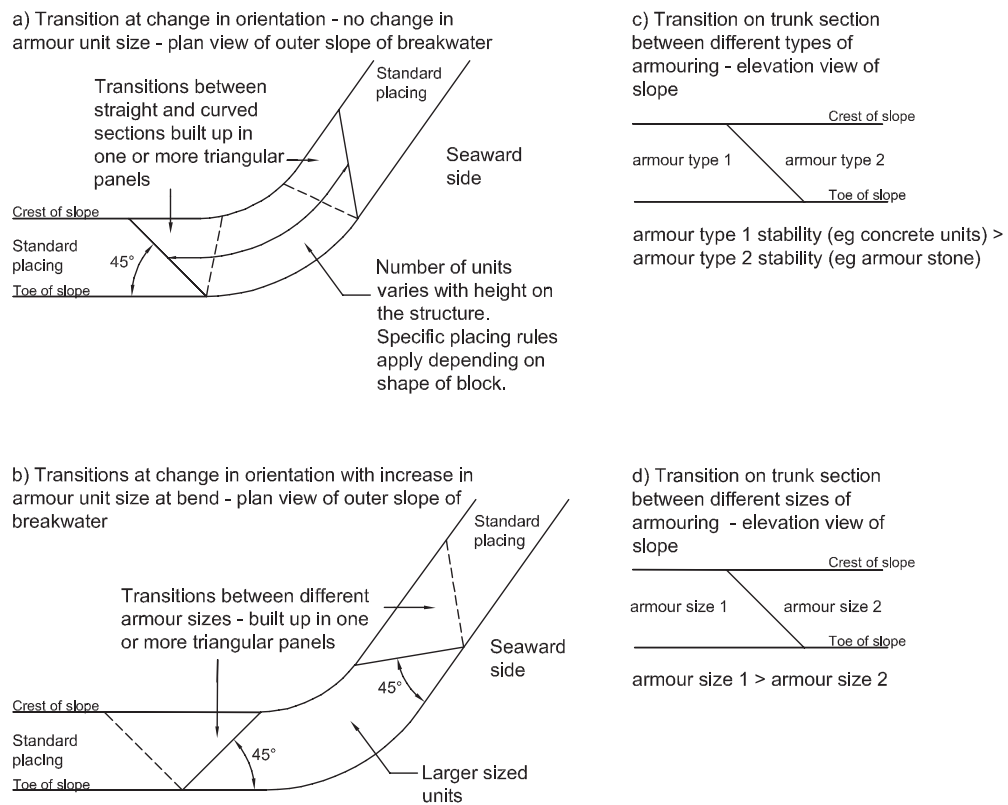

Figure 6.22 Typical transitions in concrete armour unit breakwaters

6.1.5 Rubble mound with monolithic crown wall

A rubble mound structure with a crown wall is generally designed like a conventional rubble mound, the key difference being that vehicles or pedestrians have access to the structure. Only those elements that differ from the rubble mound breakwater are discussed below.

A superstructure consisting of a concrete cap block or wave wall is named the crown wall. Design of the main dimensions of a rubble mound structure with a crown wall does not differ substantially from the guidance given in Section 6.1.4.

The crest level to be considered for overtopping is the crest of the crown wall. Specific guidance is given for calculating overtopping of crown walls in Section 5.1.1.3. The crest width is determined with the same considerations as for rubble mounds, although the required dimensions of the crown wall to prevent sliding or overtopping may dictate the wall design. Guidance for calculating wave forces on crown wall sections is given in Section 5.2.2.12. The crown wall may provide pedestrian or vehicle access along the crest of the structure. A minimum of 2 m for pedestrian access or 4 m for vehicles (single-lane) is generally required.

The introduction of a crown wall on top of a rubble mound breakwater is a logical step because:

- as mentioned above, rubble mound breakwaters are often designed to sustain some damage and access along the breakwater is needed for repairs
- a crown wall with parapet may lead to a substantial reduction in the amount of armourstone that would otherwise be needed for a comparable conventional design (see Figure 6.23)
- if overtopping is allowed, the crown wall may limit the width of the mound and by its shape protect the lee-side slope (see Figure 6.23)
- access may be required along the breakwater for port operations or for recreation.

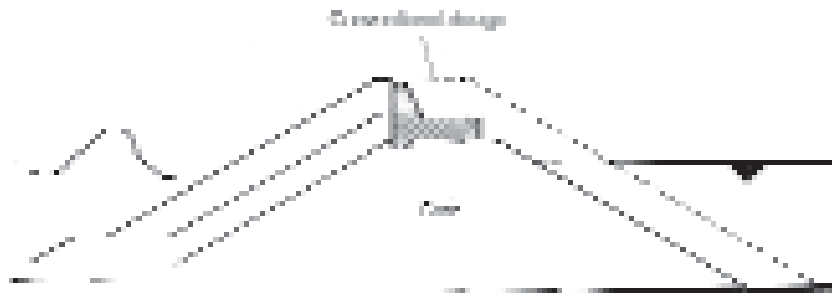

Figure 6.23 Concept of rubble mound with crown wall

Where berths are constructed immediately behind a breakwater, it is common practice for the crown wall to carry facilities for cargo loading and unloading (pipelines, conveyor systems) and electrical and water supply systems.

There are certain disadvantages related to a crown wall, which should be taken into account in selection and design:

- the crown wall represents a rigid element in a structure that is flexible by nature; uneven settlements may lead to structural problems for the elements of the crown wall and for any facilities located on the superstructure
- reduced interlocking of the upper row of armour that is placed immediately adjacent to the crown wall
- the tendency to increase the parapet wall in order to reduce the volume of armourstone can lead to very large wave impact forces on this wall
- the reduction of overtopping by a crown wall increases wave attack on the armour layer
- the crown wall increases the risk of excessive pore pressures in the mound
- overtopping water becomes concentrated into a jet, and can be a potential danger for the lee-side armour if the slab is not wide enough. Chute blocks at the inner (harbour side) edge of the slab can break the jet (see special note in the introduction of Section 5.2.2.12 and Figure 6.25c).
- higher cost and construction time compared with conventional rubble mound
- disruption in the armour layer construction sequence and increased risk of damage until the primary armour layer is completed.

The design of crown walls should begin with an assessment of their stability, using the methods and force information provided in Section 5.2.2.12. Significant design loads are the mass of the crown wall and wave forces. The horizontal force exerted on the vertical face of the crown wall is either a dynamic load (short-duration impact force caused by the wave front) or a quasi-static load, resulting from the overtopping water. Depending on the elevation of the underside of the crown wall, the mound beneath it may or may not be saturated. Wave forces and flows through the rubble mound may also lead to an increase in pressure on the underside of the crown wall causing uplift forces. Taking into account that design forces generally only occur on a limited number of crown wall elements at any one time and not simultaneously over the full length of the structure, a horizontal coupling or inclusion of keys between sections is recommended, to assist in transferring the loads.

Jensen (1983) and Palmer and Christian (1998) present the following guidelines:

- to minimise forces on the superstructure, the crown wall should not extend above the level of seaward armour (see Figure 6.24). On the lee side the primary armour should be retained by the wall to a height at least equal to 0.6 times the thickness of the armour layer
- the crown wall should be keyed into the core with a heel, such as the cut-off wall shown in Figure 6.28

- the core should be extended up to the underside of the crown wall
- the rear of the crown wall should be extended past the leeward slope to direct overtopping jets of water past the leeward armour to fall directly on the water surface (see Figure 6.25c).



Figure 6.24

Breakwater with crown wall where top of crown wall is at same level as rock armour (courtesy Clive Orbell-Durrant)

The circulation of water and pore pressure beneath the crown wall should be controlled, either with an impermeable material to prevent contact with the underside of the crown wall or with a highly permeable material to allow free drainage. Useful comments are given by Baird *et al* (1981).

With regard to practical details for crown walls, both L-shaped and rectangular options are available, as shown in Figure 6.25. The former may be built in two phases, first the horizontal slab, followed by the parapet wall, although care has to be given to the joints here as wave forces may cause damage to the parapet wall. The latter can consist of precast concrete mould elements, with a fill of mass concrete. Prefabricated concrete slabs may also be used; this allows rapid construction of the crown wall compared with the traditional casting method.

1

2

3

4

5

6

7

8

9

10

(a) L-shaped crown wall

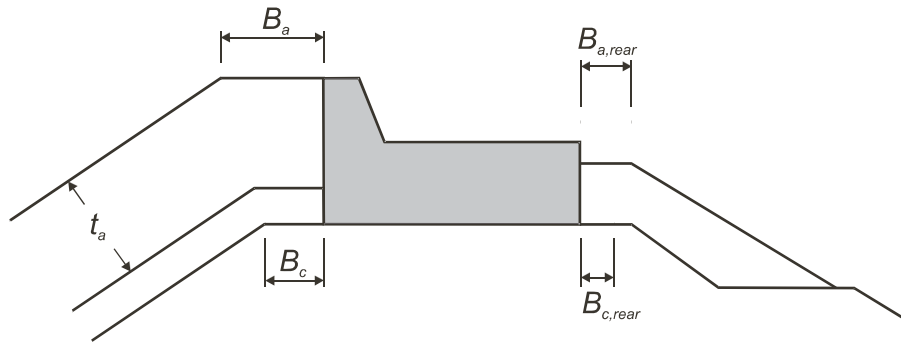

(b) Rectangular crown wall

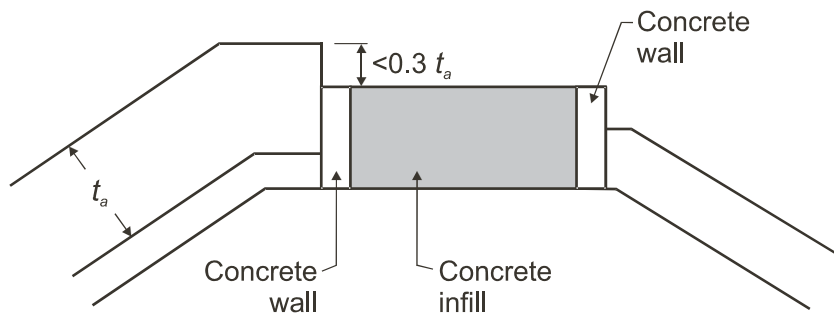

(c) Crown wall to direct overtopping away from rear armour

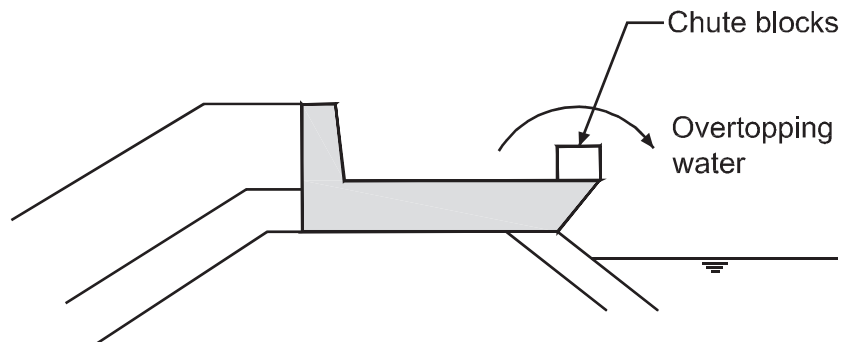
**Figure 6.25** Crown wall configurations

In Figure 6.25, B_a generally corresponds to three rows of units or stones. The height that the armour protrudes above the crown wall should be maximum $h_p = 0.3 t_a$ otherwise there is a risk of tilting of units on to the crown wall. Care is however required to minimise this height to prevent the most landward armour unit being dislodged by incident waves. If the protruding height, h_p (see Figure 6.26), cannot be limited, a slope between the armour layer and the crown wall should be designed (see Figure 6.26).

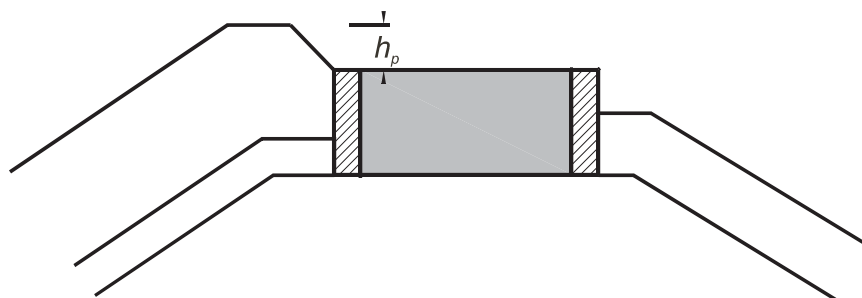
**Figure 6.26** Cross-section showing a slope between the cover layer crest and the crown wall

Generally a large stationary crane is used to place any precast elements. This can be done by working back from the head, or by dumping the stone of the core with the same crane. The choice of placing method has an effect on the required stability of the core during construction in view of the different exposure times. The width and elevation of the core and crown wall should, of course, be sufficient for the required heavy crane.

Normally it is preferable to place the crown wall on the core and not on the underlayer, in order to avoid the higher penetration of uplift pressures under the wall that occurs in the latter case. A layer of smaller material is often placed on the core to provide a level surface for the crown wall. The bottom of the crown wall should be kept sufficiently above still water level to reduce uplift forces to acceptable values to ensure stability of the crown wall section. Alternatively, the crown wall unit should have a deep enough section, and hence mass, or be sufficiently keyed into the rubble mound to provide sufficient resistance loads.

Sometimes the crown wall is made of a simple slab of mass concrete, such as in those cases where the crest elevation is sufficiently high to avoid wave pressures under the slab. High parapet walls, extending above the level of the primary armour should normally not be used, because high wave impact forces may be expected on to such walls. When a high parapet is absolutely required, the structure should be strengthened appropriately.

At the base of the crown wall, shoulders should be provided, B_c and $B_{c,rear}$ in Figure 6.25, the width of which follows from tolerance considerations, but should not be less than 0.5 m. To prevent any settlement exposing the crown wall to wave impacts, a horizontal shoulder at the top of the armour layer, B_a in Figure 6.25, of dimension approximately equal to the armour thickness or three stone rows should be applied on the seaward side. On the lee side the armourstone shoulder, $B_{a,rear}$, may be omitted if the crown wall slab extends to a point where the overtopping jets plunge directly onto water without eroding the lee-side slope (see Figure 6.25c).

Concrete armour units are often used with a monolithic crown wall. Design rules are standard (see Section 5.2.2.3), but the need to achieve good packing next to the wall may be a constraint on geometry. The space between the last upper row and the wall depends on the packing density of the armour layer and the relative position of the wall. Various options are possible:

- there is exactly enough space for one block. While recommended, this is rarely achievable
- there is too little space for the unit, the gap may be filled up with partially broken units or very large stones. The hydraulic stability of such an arrangement should be checked
- there is too much space for a single row. Special arrangements should be made. For some units special positioning rules have been developed to ensure good positioning of the units at the crest.

The exact number of artificial armour units cannot be known with accuracy until the work is done because it depends on the exact number of entire rows that can be fitted into the space available on the crest. It is therefore advised to ensure some flexibility for adjusting the number of units to be prefabricated at a late stage in the construction process.

Figure 6.27 shows an example of design with a double layer of concrete cubes where the underlayer has been reduced immediately in front of the base of the crown wall. This should generally be avoided, since this configuration reduces the filter's effectiveness for water retention. In addition, high flows generally result from the discontinuity in permeability caused by the crest wall itself. Finally, different construction methodologies are involved in the construction of the point of contact between the core, the filter layer and the crown wall, making this a difficult zone to build. A recommended alternative design is shown in Figure 6.28 where the filter layer has a constant thickness and the crown wall has a cut-off toe. Note that this type of crown wall may be more difficult to build.

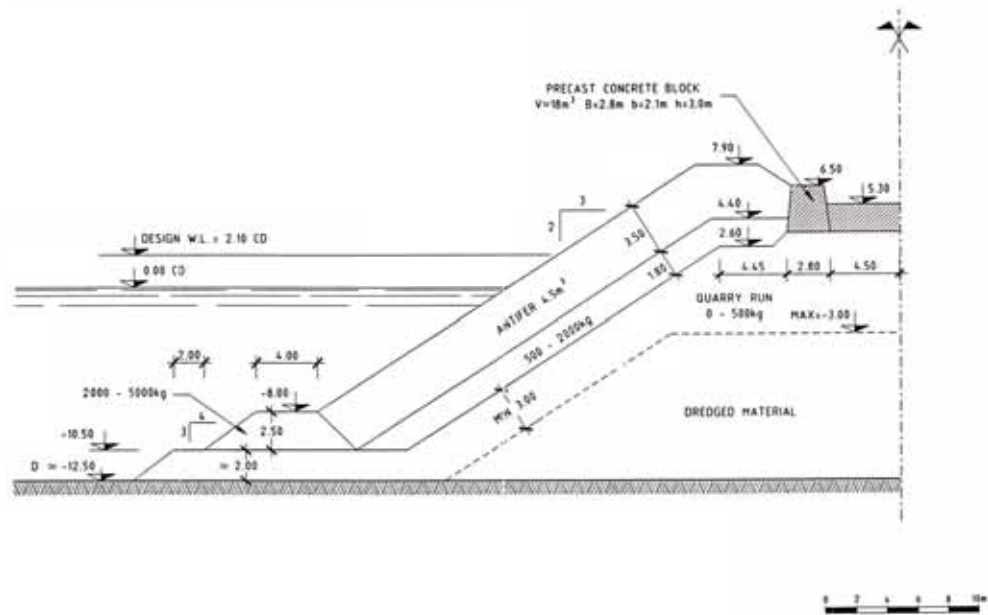

Figure 6.27 Double-layer concrete-armoured breakwater with underlayer of reduced thickness adjacent to crown wall

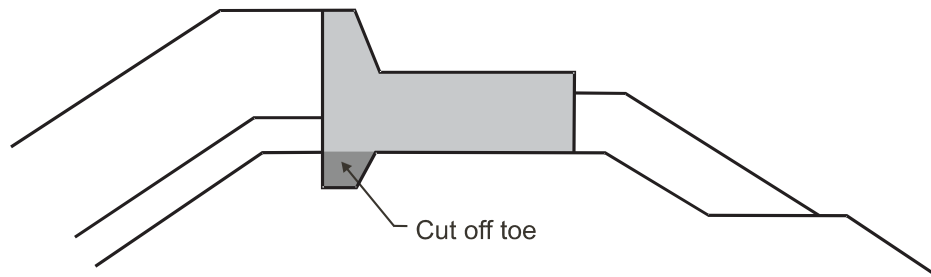

Figure 6.28 Breakwater with crown wall and cut-off toe and sub-layer with constant thickness

6.1.6 Berm or S-slope breakwater

The first berm breakwaters were built with a homogeneous berm, for example the St George berm breakwater in Alaska (Gilman, 1987). The first modern berm breakwaters were built as dynamically stable reshaping breakwaters. The berm breakwater concept has evolved into the multi-layer berm breakwater. The advantage of this latter type is that it makes more efficient use of the quarry yield, to almost 100 per cent. The present state-of-the-art approach is to design a berm breakwater as a multi-layer statically stable or as a statically stable reshaping breakwater – as, for example, the Sirevåg berm breakwater, in Norway (see Box 6.5). PIANC (2003) presents a detailed review of current practice for the design and construction of berm breakwaters.

The berm breakwater offers great flexibility for the designer. The design should be supply-based, that is based on quarry yield, rather than demand-based, in which the armourstone and core material requirements are set by the designer. The specifications should therefore be *functional specifications*, not *demand specifications*. This makes it essential to investigate the yield from potential dedicated or other quarries at an early stage of the design process. Methods to investigate and predict the quarry yield are described in Section 3.9.5.

Three main types of berm breakwater are generally identified:

- non-reshaping statically stable
- reshaped statically stable
- dynamically stable reshaping.

The following design approach may be used for selecting an appropriate form of rubble mound breakwater.

- 1 Local (or other) rock sources should be evaluated before concept selection.
- 2 Evaluate whether it is economical to design a conventional rubble mound breakwater (as discussed in Section 6.1.4), using the design guidance in Section 5.2.2.2 to select an appropriate minimum armourstone size.
- 3 It may be more economical to design a berm breakwater with the largest stone class similar to that predicted from the equations given in Section 5.2.2.2 for conventional rock armour layers on non-overtopped structures or with the stability number, $H_o = H_s/(\Delta D_{n50})$ up to say 2.0, a **statically stable non-reshaping** berm breakwater (see Section 5.2.2.6). The demand for large stones is usually less for this option than for a conventional rubble mound and can often be more economical, particularly if there is a dedicated quarry.
- 4 If large stones of sufficient size are not available, then a **statically stable reshaping** berm breakwater may be adopted; it has a wider cross-section with a greater volume.
- 5 If the options above are not possible, a **dynamically stable reshaping** berm breakwater may be adopted that has an even wider base and requires a greater volume of stone.

6.1.6.1 Main dimensions

The main dimensions of a berm breakwater are shown in Figure 6.29. Strict rules on these main dimensions have not evolved. The size of Class I stones is governed by the quarry yield and the recession and the mode of reshaping (statically stable, reshaped statically stable and dynamically stable). These parameters are calculated and evaluated by the methods given in Section 5.2.2.6. Preferably the **berm breakwater should be non-reshaping statically stable**, but a reshaped statically stable berm breakwater may be acceptable. Reshaping dynamically stable berm breakwaters should normally be avoided, because the dynamics of the stones rolling up and down the slope may cause unacceptable breakage of the stones. Stone integrity and resistance to attrition are key factors for berm breakwaters, because of the potential mobility of the stones. Methods to estimate the strength and thus the suitability of stones from a given quarry for a berm breakwater are described in Section 3.8.5. Studies to quantify the risk of breakage are discussed in PIANC (2003).

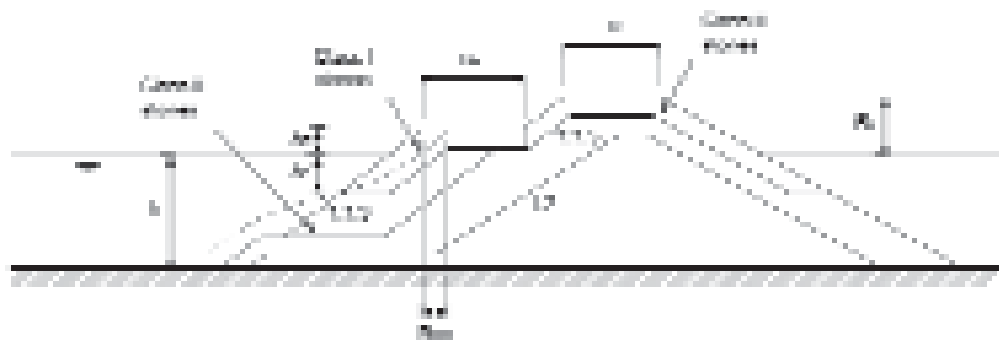

Figure 6.29 Main dimensions of a multi-layer berm breakwater and main stone classes. Slopes shown are indicative of typical slopes – other slopes may be adopted

The lowest position of Class I stones on the seaward face should preferably be at the level of h_f , defined in Section 5.2.2.6. However, examples exist where this is not the case. The Sirevåg berm breakwater has the lowest position of Class I stones on the seaward face at 1 m below Chart Datum (Lowest Astronomical Tide level).

Class II stones are used to armour the crest and the zone immediately below the Class I stones and are sized with methods described in Sections 5.2.2.11 and 5.2.2.9 respectively. The latter zone is then regarded as a relatively high toe, with h_f being the *extreme* toe depth, h_t

(m), in Equations 5.187 and 5.188. Moving further down the slope towards the toe, progressively smaller stone sizes may be used as the exposure to wave loads is reduced.

The width of the berm, B_B (m), should be governed by balancing breakwater costs with the probability of damage of the breakwater. The minimum width should be the recession from the maximum design waves. It is preferable to make the berm as wide as possible and the increase in costs can be marginal for making the berm width to be at least the expected recession for a more extreme storm, for example the 1:1000-year wave.

The berm height should be in the range $h_B \cong (0.5-0.9)H_s$ (m) above the design water level, but from the few tests that have been carried out with varying berm height, and summarised by Tørum (1999), there is no significant effect on the recession from varying berm height within the range $h_B/D_{n50} = 2-4$.

The crest height, R_c (m), is governed by the acceptable overtopping rate. The overtopping rate is calculated using the methods given in Section 5.1.1.3. Frequently the crest height is set in the range $R_c = (1.0-1.4)H_s$ (m) but the height should to a large extent be governed by acceptable overtopping rates for harbour facilities located in the area behind the breakwater.

The berm breakwater head should be given special attention. Extensive model tests on the trunk and head of a reshaped dynamically stable berm breakwater, H_o up to 4.0, with a homogeneous berm were carried out by Juhl *et al* (1997). In this case there was transport of berm stones into the area behind the breakwater head. Design of berm breakwater roundheads is discussed in Section 5.2.2.13.

Box 6.5 *The Sirevåg berm breakwater, Norway*



Figure 6.30 *View of the front side of Sirevåg breakwater, Norway (courtesy HR Wallingford)*

The Sirevåg berm breakwater (see Figure 6.30 on previous page), was designed as a statically stable berm breakwater (with minimal reshaping) for $H_s = 7.0$ m, $T_p = 14.2$ s (1:100-year wave conditions), see Sigurdarson *et al* (2004, 2005). The design was also required to withstand the 1:1000-year wave condition without suffering catastrophic failure. The breakwater is about 500 m long and seabed levels along its length vary from 3 m to 22 m.

The aim of the breakwater design was to achieve an economic design based on optimisation to match quarry yield predictions from locally available rock sources. Three possible quarries were assessed and quarry yield predictions were produced for the 640 000 m³ of armourstone and core required for the breakwater construction. The cross-section design was then developed based on the relative yields in the armourstone size classes defined below in the note to Figure 6.31. The largest armourstone class was located on the berm, close to the still water level, as this is the zone of most severe wave attack. The cross-section is shown in Figure 6.31.

Box 6.5 The Sirevåg berm breakwater, Norway (contd)

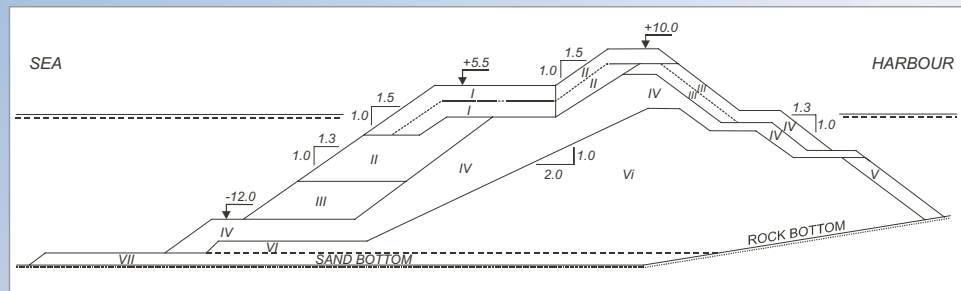

Figure 6.31 Cross-section of the Sirevåg berm breakwater – statically stable with a multi-layer berm.
 Note: Stone classes: Class I: 20–30 t; Class II: 10–20 t; Class III: 4–10 t; Class IV (filter): 1–4 t; Class V: 0.4–1 t; Class VI: core, quarry run

During the first winter in service, the breakwater experienced a storm that exceeded the design level, estimated to have a maximum $H_s = 7.9$ m at the breakwater ($H_s \cong 9.3$ m at a wave buoy seaward of the breakwater). The breakwater functioned well during this storm with a minimal amount of reshaping on the berm and front slope (Tørum *et al*, 2003b,c; Sigurdarson *et al*, 2004).

Although model tests were not undertaken as part of the design process, they were later completed as part of a research study. This has allowed assessment of behaviour of the breakwater in storms exceeding the design condition. Model tests showed that the breakwater was reshaped into a statically stable profile for the storm experienced by the breakwater – $H_s \cong 9.3$ m, $T_p = 16.4$ s (1:10 000-year waves). The physical model indicated that recession due to this storm was on average $Rec = 8.2$ m or $Rec/D_{n50} \cong 4$, or less than half of the berm width, $B_B \cong 20$ m. The recession is apparently to a large extent governed by the Class I stones on top of the berm. This complies with the findings of Westeren (1995) and Tørum (1997) that the wave forces on individual armour stones on a reshaped berm breakwater are largest in the upper part of the berm, where in this case the largest (Class I) stones are located. When there are large stones in this area the recession is withheld compared with a berm containing smaller, eg Class II, stones in this area.

During the reshaping process most of the Class I and Class II stones that moved were displaced down the slope, indicating that an S-shaped profile is the preferred equilibrium profile. Construction methods presently available do not allow economical construction of an S-shaped profile.

The Sirevåg berm breakwater has been designed with the same profile for the breakwater head and the breakwater trunk. The stability tests for this breakwater showed that there was hardly any transport of stones into the area behind the breakwater roundhead (Menze, 2000; Tørum *et al*, 2003a).

From the model tests (Menze, 2000; Tørum *et al*, 2003c) some reshaping was expected on the prototype breakwater for this storm. However, actual reshaping was significantly less on the prototype. There was some difference between the model and prototype with respect to berm stone placement. The potential causes of these differences were evaluated. This indicated that a key factor contributing to the differences in behaviour was the manner in which the armourstone had been placed on the structure, in particular the Class I stones, placed on the berm. In the model, these stones were placed randomly on the breakwater. In the prototype a more orderly placement was adopted, which appears to have contributed to less reshaping. It seems that it is preferable to place the berm stones in an orderly manner, but the effect on the stability or reshaping of the difference in construction methods has not yet been extensively explored.

6.1.7 Caisson-type breakwaters

Caisson-type breakwaters have found wide application in some Mediterranean countries, eg Italy, and in Asia, eg Japan. The different types of composite breakwater are presented in Figure 6.3, which shows the three concepts (or sub-types) that should be distinguished, each having specific conditions and design criteria.

Caisson structures are generally more economical in deeper water. Sufficient water depth is necessary to allow floating of the caissons to the required location. For depths of 15 m and more the caisson is often more economical than a rubble mound. For depths of 10 m and less the rubble mound is generally more economical.

All three sub-types of caisson breakwater often comprise quarried rock as an important part of the structure and this aspect of caisson breakwaters is therefore addressed in this manual.

In sub-type 5a in Figure 6.3 the use of armourstone is limited to a foundation layer only. This design is consequently attractive in countries where insufficient good-quality rock for the construction of a conventional rubble mound breakwater is available.

The width of the caisson increases with increasing water depth and the vertically composite breakwater, sub-type 5b in Figure 6.3, may become an economical alternative in certain situations.

In the past many failures occurred to caisson or vertically composite breakwaters because of very high impact forces caused by breaking waves. If, at a specific location, the wave conditions are such that breaking waves can occur, a horizontally composite breakwater, type 6 in Figure 6.3, may present a viable alternative. Initially, the solution was developed in Japan to protect existing caisson-type breakwaters against (further) damage. At present, it is still applied at sites where armourstone is scarce and breaking waves cannot be excluded.

Caisson type on rip-rap foundation

The principal failure modes are shown in Figure 6.12:

- horizontal sliding (1) occurs if the total horizontal wave force exceeds the friction resistance at the interface between caisson and foundation
- overturning (2) implies a rotation around the lee-side end of the concrete structure (point A), which means the effective stress around point A increases such that the stones are crushed
- if horizontal sliding does not occur at the underside of the caisson (for example, by provision of keys), a failure of the upper part of the foundation may occur, called a planar slip (3)
- geotechnical instability along a slip circle (4) can occur in very poor conditions of the existing subsoil; see Section 5.4.3.2
- wave impact forces on the caisson may result in liquefaction (7) if the subsoil consists of loosely packed sand
- finally, the wave action in front of the caisson may lead to damage of the toe (5) – see Section 5.2.2.9 – or erosion of the sea bed outside the toe (6).

The design of the caisson stability, involving mechanisms (1) to (4), is determined by an extreme wave height-wave period combination, while the instability of the toe (5) is linked to the occurrence of a design storm, characterised by a significant wave height, usually combined with a low water level. This difference is due to the fact that a single extreme wave condition may cause the caisson failure, in contrast to the more gradual process of (hydraulic) damage to a mound of stone. Different probabilities of exceedance will thus be applied in defining the single design wave height, $H_{d,c}$, for the caisson design and the significant wave height, H_s , for design of the toe.

Failure mechanisms (1) and (2) are not directly influenced by the armourstone foundation and are therefore not relevant within the framework of this manual. Guidance on calculating wave forces for use in calculations for these mechanisms can be found in Oumeraci *et al* (2001). Global stability equations for these mechanisms are however given with reference to crown walls in Section 5.2.2.12. Selection of appropriate friction angles at material interfaces is discussed in Section 5.4.4.5.

For the hydraulic stability of the rubble mound foundation, reference should be made to Section 5.2.2.9 where preliminary design formulae are given. For detailed design, model tests should normally be carried out. These allow the wave pressures on the caisson to be measured and the stability of the foundation material to be assessed.

Toe erosion may be caused by the high velocities that occur in the node of the standing wave pattern seaward of the breakwater. A rule-of-thumb approach suggests that an area of up to three-eighths of a wavelength, measured from the vertical face, may be subject to possible erosion. The need for bottom protection depends largely on the width of the toe structure and its flexibility to follow erosion immediately seaward of it.

Vertically composite breakwater

As indicated above, this type of breakwater becomes attractive when the water depth increases. The design has one potential danger: incoming waves are forced to break by the underwater mound and cause impact wave forces on the caisson. For that reason, the mound should not be too high and the width of the seaward berm should not exceed $1/20L$, where L is the length of the steepest design wave that can occur at the breakwater. It is necessary to check the final design in model tests for a range of wave conditions to ensure that no vertical wave front hits the caisson.

For vertically composite caisson breakwaters, failure mechanisms are very similar to those for conventional caisson breakwaters, as shown in Figure 6.12 and the design approach for mechanisms (1)–(4) and (6) is also the same. For stability of the primary armour layer protecting the berm against hydraulic damage (5), design information is provided in Section 5.2.2.9.

Horizontally composite breakwater

The mound in front of a caisson should break and absorb part of the wave energy effectively. In most of the examples of this type built in Japan the mound consists of one type of concrete armour unit, without core or filter layers, in order to achieve a high porosity. Bulky concrete armour units are generally preferred. A mound of armourstone may also be used. Because of this protection the impact wave forces on the caisson are greatly reduced. However, the same failure mechanisms apply to this type as for the previous two, since quasi-static wave pressures penetrate the mound. The hydraulic stability of the mound is basically similar to that of the primary armour layer of a conventional breakwater. However, the stability coefficients in the design formulae (see Section 5.2.2.2) are different because of the high porosity on the one hand, and the reflecting caisson face on the other. Japanese test results in the form of a damage coefficient K_D versus percentage damage show considerable scatter (Tanimoto *et al*, 1983). No conclusive relationship can be obtained from them and hence model tests are required to confirm any particular design. Structure-specific studies should be performed to check the resistance of the armour units within a multi-layer system.

Special considerations at junctions with rubble mound structures

As caisson structures can only be placed in a sufficient depth of water, in some cases a rubble mound can be used from shore with a transition to a caisson in water of sufficient depth. The junction with the caisson is a location where there may be concentration of wave action and where the contact with the concrete creates a weaker area because of the lack in interlocking at the transition between the caisson and the rubble mound armour.

A radius similar to the roundhead radius is recommended for transitions where a rubble mound meets a concrete structure, see Figure 6.32.

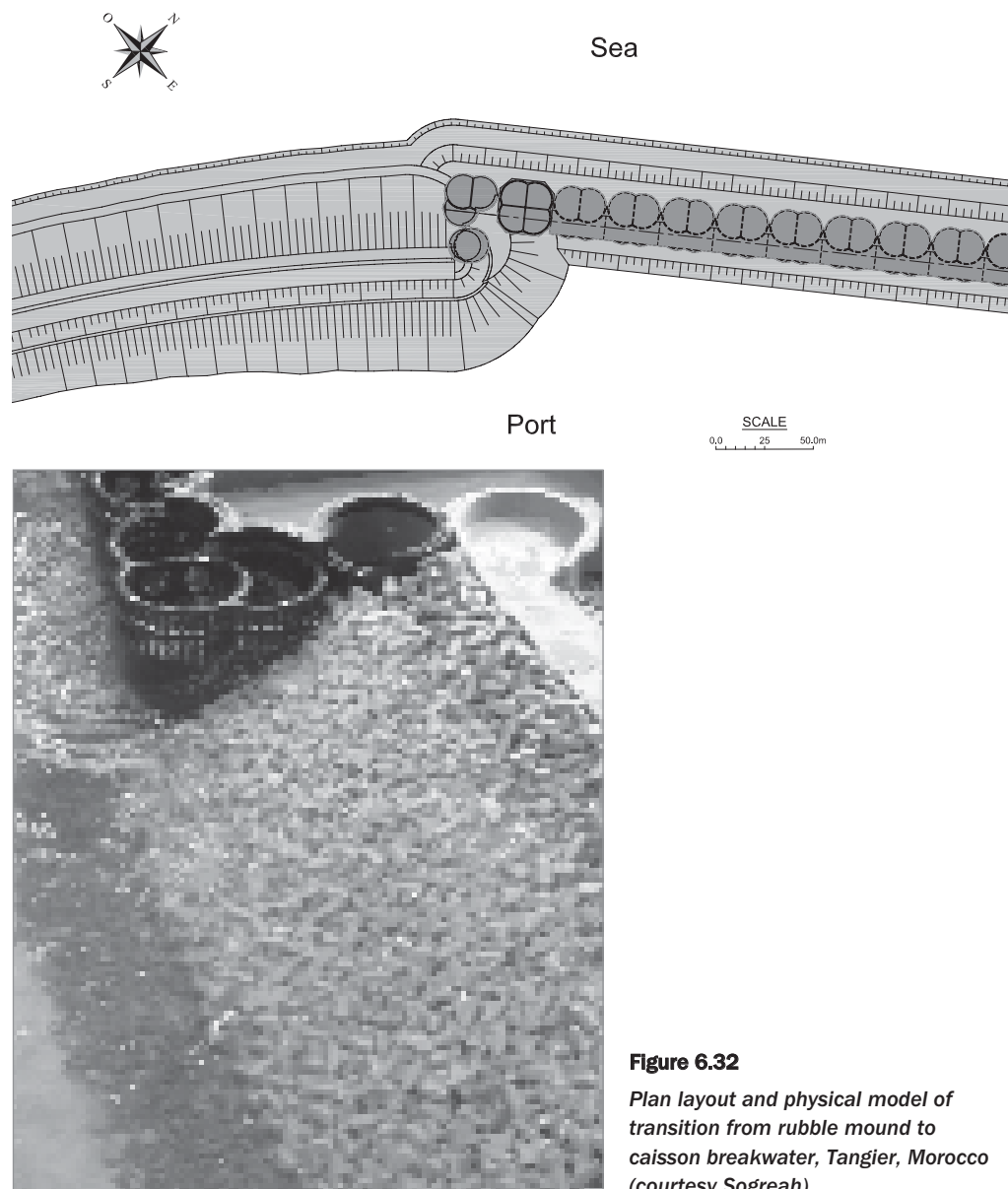

Figure 6.32
Plan layout and physical model of transition from rubble mound to caisson breakwater, Tangier, Morocco (courtesy Sogreah)

6.1.8 Cost aspects

Cost aspects should be considered during the design phase. Approaches to the costing of projects throughout the design life are discussed in Section 2.4.

As accurate assumptions on construction techniques often cannot be made in the design phase, the approach to project costing during design is essentially based on quantities and unit rates for the different components of the structure (see Table 2.6). It should be noted that in certain cases much greater material volumes may still lead to lower costs in relation to particular local construction techniques.

At the bidding stage, the contractor should undertake a more accurate cost analysis and may modify the proposed design based on his work methods and optimised use of equipment, to produce a more cost-effective design.

Once the volumes are estimated and the unit rates are known to a reasonable degree of accuracy the designer should compare the cost of each component of the structure to the failure analysis modes (see Section 6.1.3) and the functional and performance requirements of the structure. Re-analysis of each zone of the structure with respect to the cost and risk may then allow refinement of the structure design. For example, the effect of oversizing the

elements of the structure to reduce the risk of failure can be assessed. It may be that oversizing will not have a proportional impact on cost, because it may result in fewer elements and hence will demand fewer construction operations, which could be particularly significant in the case of waterborne operations.

A similar analysis should be run for the risk during the works in terms of procurement of materials, damages to the works, delays and any type of contingencies that can be reasonably anticipated for the whole duration of the works, from the placement of the core material and until the whole structure is constructed at its final designed stage.

At preliminary design stage, total costs can be estimated with unit rates and quantities. Table 6.2 gives indicative values of unit quantities for two types of rubble mound breakwaters. From this table it can be noted that the armour layer, which is usually the most expensive part of the structure, is a relatively small proportion of the total material volumes required for construction. More examples of unit quantities are presented in Box 6.6.

Table 6.2 Volume ratios (rules of thumb)

Material	Double-layer rubble mound breakwater (%)	Single-layer rubble mound breakwater (%)	Proportionality of volume to height
Armour layer	10–30	5–15	volume \propto height
Underlayer and filters	5–20	5–20	volume \propto height
Berms and anti-scour layers	0–10	0–10	–
Core	40–70	50–80	volume \propto height ²

Unit rates are highly dependent on the quality of the material, the source of the material and on the work methods.

Unit rates may be well established in certain countries, but in more remote locations or where quarried rock is not readily available a local study may be necessary to obtain cost information. Typical rates are not given here because changing market conditions can affect costs significantly.

6.1.8.1 Cost aspects related to the production of armourstone for breakwaters

If a dedicated quarry is opened for the works, the unit rates depend primarily on the production costs. In this case the total production volume required from the quarry depends on the theoretical volume required in each stone size category, the losses and the fragmentation curve achieved in the quarry (see Section 3.9). Any volume requirement for a particular category in excess of the fragmentation curve will require a proportional extra production for all categories (see Figure 6.33). The excess production for the other categories is to be considered as waste unless other commercial uses can be found.

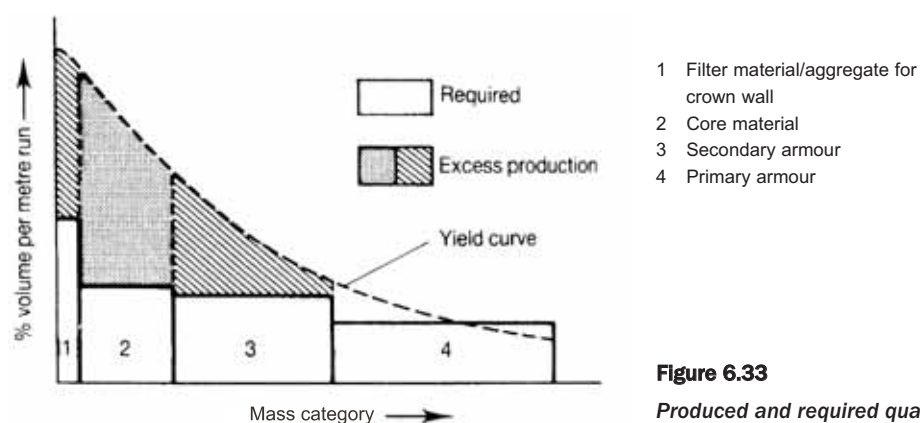
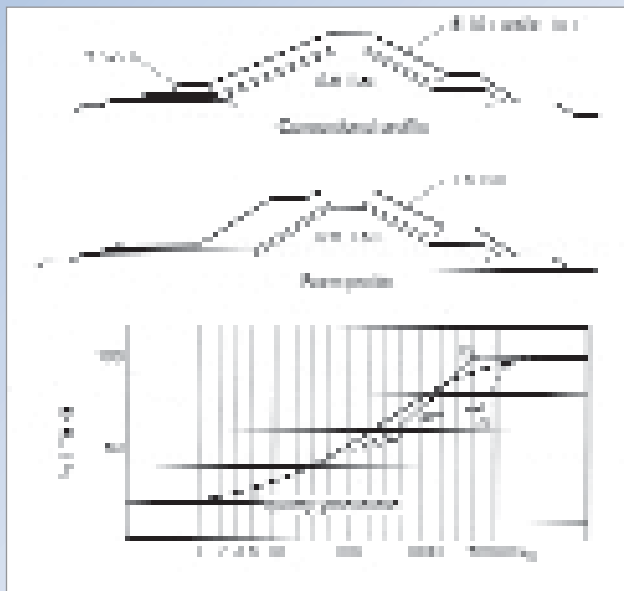

Figure 6.33
Produced and required quarry output

Box 6.6 Matching demand for stone to quarry fragmentation curves

The actual production of quarry stone depends not only on the total theoretical volume required but also on the match of the demand curve to the yield curve of the quarry. Since typical quarries produce only few heavy armour stones, this category determines to a large extent the required production. Important cost savings can be realised by designing with the best match possible.

As an example, two breakwater sections with similar safety are compared, one a conventional type (A) and the other a berm-type breakwater (B), see Figure 6.34. The quarry yield and stone requirements for the two different cross-sections are given below and in Table 6.3.

**Figure 6.34**

Cross-sections and quarry yield curve compared with demand curve for conventional rubble mound and berm breakwaters

Table 6.3 Comparison of match between design and quarry yield (critical grading in bold)

Category	Average yield (%)	Conventional type		Berm type	
		Volume required (%)	Volume to be produced (%)	Volume required (%)	Volume to be produced (%)
Filter	–	11	–	11	
Core	70	45	350	48	98
0.5–1.5 t	15	16	75	20	21
1.5–5 t	10	3	50	21	21
5–10 t	5	25	25		
Total	100	100	500	100	140

In order to produce the quantity of stone in the 5–10 t category that is required for the conventional rubble mound (A) (25 per cent) an additional 400 per cent of material must be produced in the quarry, with excess quantities produced for the lower grades of stones. For the berm breakwater (B) an additional 40 per cent production is required to produce the quantity of the largest armourstone size that is required.

It is not unrealistic to assume that the costs for drilling, blasting and handling in the quarry are 30 per cent of the total costs of quarried stone in the stockpile. These production costs may typically represent 25–35 per cent of the unit cost of armourstone placed in the breakwater, so the costs of drilling, blasting and handling in the quarry amount to $0.3 \times (0.25-0.35)$ or approximately 10 per cent of the total quarry costs in the breakwater.

Therefore the excess production in the quarry of 400 per cent that is required for the conventional breakwater compared with the excess 40 per cent required for the berm breakwater represents an extra cost of $0.1 \times (400 - 40) = 36$ per cent in this case.

The optimum cost is arrived at where the required quantities and sizes of armourstone match the yield curve. Since only a small fraction of the total production provides large blocks, the required volume of these is critical and often leads to overproduction of smaller sizes. An example of this optimisation is given in Box 6.6 and the process is considered in more detail in Vrijling and Nooy van der Kolff (1990).

Every effort should be made to tailor the design to the anticipated yield curve. It should further be borne in mind that frequently the actual yield curve is quite different from the anticipated fragmentation curves (see Section 3.9).

Particularly for large breakwater works, the designer should check that the volume of armourstone to be placed in the structure is not excessive compared with the standard production output of local quarries if they are to be used. Excessive demand on limited resources can significantly increase costs.

Armourstone can sometimes be obtained from permanent quarries. For aggregate quarries, which are by far the most common, the large blocks are considered as waste or by-product. Collecting these wastes (preferably in standard gradings) from a number of quarries can sometimes be an economically attractive option for small projects. However, required production rates of 10 000–20 000 t per week are not unusual for a breakwater, with 50 000 t being common for larger breakwaters, so often a dedicated quarry is required to meet such a demand.

6.1.8.2

Cost aspects related to design and construction of breakwaters

Cost optimisation takes place during different project stages, as described in Section 2.4. Some examples are given below of considerations for cost optimisation for breakwaters in terms of structure optimisation and construction process optimisation.

Core material

In the design process, there is a strong emphasis on the stability of the armour layer of the breakwater. For the construction and the total costs, however, the armour layer is often not so important. In particular, the breakwater core, and also the toe protection and the underlayers, can represent high percentages of the total cost.

The core material is usually the cheapest grade of armourstone, namely quarry run (see Section 3.4.4). Risk of damage of the core can limit the working conditions to a certain significant wave height. Higher wave heights can result in damage and loss of material as the core is being placed. To reduce downtime, sometimes it may be advantageous to use heavier but more costly grades of stone for construction of the core when the waves exceed the limit for quarry run. An example of reuse of dredged material as core to minimise the required quantity of quarried core material and hence cost is given in Box 6.7.

Armour units

Armour units used on the seaward slope of rubble mound breakwaters tend to be heavy and the placing has to be done very carefully in a predefined way. The rate of progression of the construction is therefore defined by the time needed to place the armour stones or units. Each armour stone takes about the same time to place and the time is independent of the mass (within a fairly wide range), so progress depends on the number of stones to be placed per metre length of structure. A steep slope with a few heavy stones permits faster progress than a gentler one with many smaller stones. In some cases it might even be cost-effective to over-design the stone or unit mass, thereby reducing the number of stones to be placed, to save time.

Box 6.7 Use of dredged material as an alternative to quarried rock

A cost-effective project design should ideally take advantage of locally available construction materials. The core material is in volume the greater part of a rubble mound breakwater. Use of suitable locally dredged material can provide significant cost benefits since it avoids extraction and land transport of material and makes use of a material that, in many cases, has to be sent to a spoil area. Dredged material is generally rather fine compared with quarried material and has poorer stability performance (more gentle side slopes under water) and higher compressibility potential. Nevertheless, generally it can be substituted for quarried material, as shown in Figure 6.35, provided that adequate measures are taken to prevent the fine material from washing out through the covering layer of quarry run near the sea-side toe. In particular when the use of sand is considered, measures such as geotextiles should be part of the design to minimise the risk of washing-out of fines and subsequent settlement of the entire structure. The elevation of the top of the dredged material depends on the method and equipment used for placement. In some circumstances it is economical to use more gentle slopes for the breakwater so as to allow the use of dredged material (in particular gravel) and build a stable profile with material of lesser stability performance.

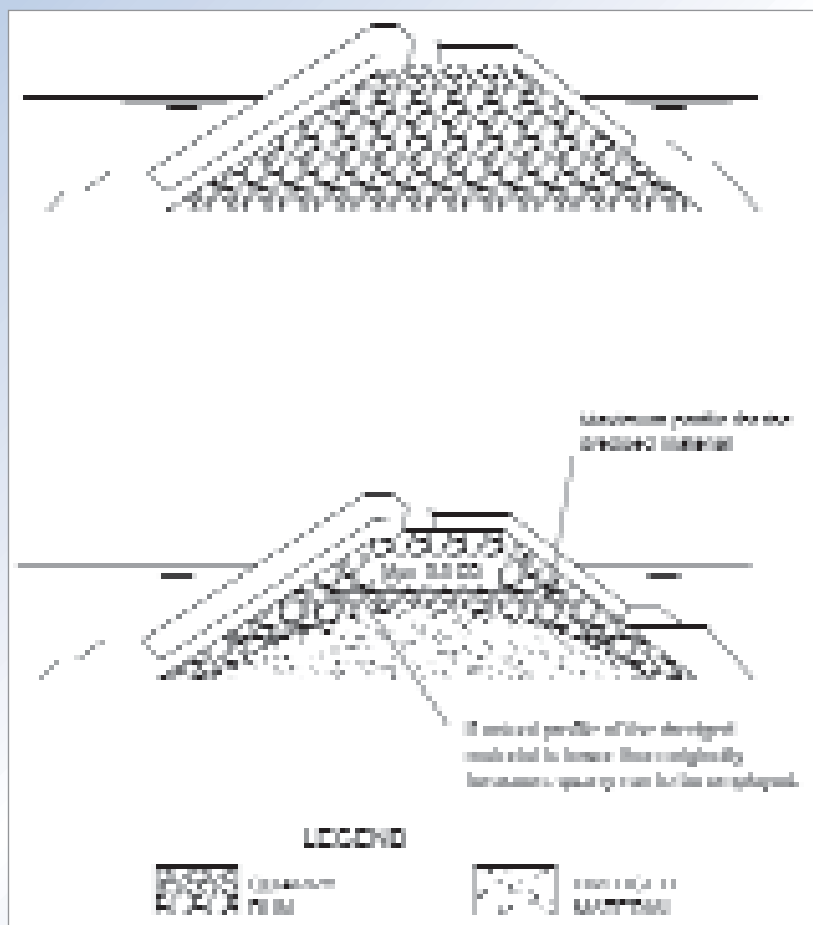

Figure 6.35 Use of dredged material as an alternative to quarried core material. Top: design without considering the use of lower-cost dumped dredged material; bottom: alternative design with dumped dredged material (courtesy Sogreah)

These considerations tend to give preference to heavy armour on steep slopes. However, should heavier armour necessitate use of a larger and more expensive crane, there may be an upper limit to the size of armour units that can be practically adopted. A possible increase in sensitivity to damage should be considered, particularly for concrete armour units, as larger units may be more susceptible to breakage (see Section 3.12). This may be offset by the lower probability of damage because of the increased factor of safety for stability provided by the larger armour units.

Crest width

If land-based equipment is to be used to place the material for the armour, the width of the breakwater should be determined with regard to the possibility of establishing a construction road wide enough to allow stone dumpers to pass the crane and to turn (see Section 9.7.2.2). If the crest is too narrow for this, a wider structure needs to be designed or a construction road needs to be established at a lower level where the structure is wider. A low-level road reduces the reach of the crane necessary to place stones at the toe of the slope, but it will result in more downtime during construction because of overtopping.

Although there may be a specific design criterion for the crest width once the structure is completed, this width should be checked for accessibility for construction and future repairs. Placing armour units from the exposed seaward side using floating plant can be approximately three times more expensive than using a land-based crane. However, working with a land-based crane requires a large crest width. Although the most economic crest depends on each individual case, there is a strong tendency for narrow crests.

6.1.9 Construction issues that influence design**6.1.9.1 Construction method**

The minimum overall dimensions of a breakwater cross-section are determined by the hydraulic interactions and functional requirements discussed in Sections 6.1.3–6.1.7. Determination of the actual dimensions of the structure are based on the construction methods to be used. The minimum dimensions established during the design may be sufficient to allow use of standard construction equipment. If not, it may be necessary to increase the dimensions to ensure the structure can be built. It is essential that the designer understands how the structure is going to be constructed and makes provision in the design for the relevant dimensions and specifications.

The choice between land-based and waterborne equipment, or a combination of both types of equipment, will influence the design of the breakwater. Considerations to help in the selection of appropriate construction techniques are given in Section 9.7.2 and considerations are also discussed in Section 6.1.8.2 with respect to cost.

When constructing with land-based equipment, the main requirement is that the crest width at 1 m or more above the maximum sea level is sufficient to allow for the appropriate traffic. The type of crane to be used becomes a boundary condition for the dimensioning of the breakwater crest, as the crane should have a sufficiently wide track from which to operate (see Section 6.1.4.1). The type and size of crane required depends on the size of the armour stones or concrete units to be placed at the toe and at the crest of the structure. Crane capacity details are given in Section 9.3.

When providing sufficient crest width above water becomes uneconomical, floating equipment can be employed for the toe and the berm (see also Section 6.1.8.2). This option becomes more appropriate when using concrete armour units. The mass of concrete units can easily reach 50 t and more. These units are often used in deep-sea structures. The use of heavy lift equipment then becomes essential and it is difficult and uneconomical to do all the work with land-based equipment.

The use of waterborne equipment is practical for dumping materials. The main constraint is that materials cannot be dumped continuously when the depth of water under the dumping area is less than 3 m below low water. This becomes an issue when selecting the core level. Floating cranes for higher parts of the breakwater are generally not used because of limited workability and poor accuracy of placing.

6.1.9.2 Placing tolerances

Placing tolerances depend on the equipment, the method of placing used and the size and shape of the material. The selection of appropriate tolerances at the design stage is based on a balance of what can be practically achieved, what is required for the stability of the structure and the cost.

Practical achievable tolerances are given in Section 9.3.7 for different types of equipment and stone sizes. Practical tolerances should be taken into account in the design. For example, tolerances related to the layer thickness are important because they eliminate the possible accumulation of negative deviations from the design profile, which could then lead to unacceptably thin layers. The interface between various construction activities has to be designed by keeping in mind the different tolerances, for example, at a transition berm, as illustrated in Figure 6.36. This shows a berm between smaller Category 1 stones on the lower part of the structure and larger Category 2 stones on the upper part of the slope. Stability of the Category 2 armour layer relies on the existence of the berm and the degree of deviation from being horizontal. Note that the inner end should never be higher than the outer end. The designer therefore needs to take into account the possible deviation from the design profile during construction in order to ensure that the berm will actually be created. The berm should therefore be sufficiently large to accommodate tolerances while still providing suitable support for the Category 2 stones.

A very important cause of potential damage exists in relation to the layer thickness. It is essential that the design allows for the correct thickness of the different layers of a structure and it is essential that the quality control on site is such that any deviation is detected and corrected.

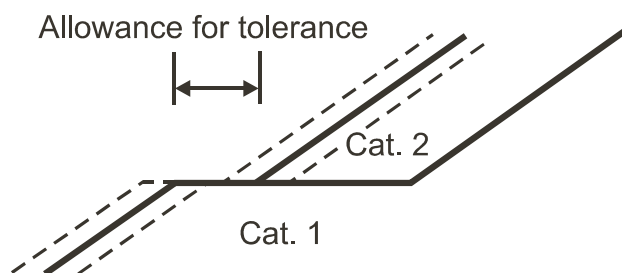

Figure 6.36 Allowance for layer thickness tolerances at a transition berm

Concrete armour layers

Placing tolerances for concrete armour units are specific to each type of armour unit. Most units are individually placed and tolerances should apply to the placement of each unit. Absolute tolerances at the outer perimeter of the armoured area and relative tolerances between units inside the armoured area should be defined.

Relative placing tolerances can either be given as a percentage of the placing grid, such as 10–15 per cent for tetrapod units both horizontal, Δx , and slope-parallel, Δy , and 13–15 per cent of the horizontal centre-to-centre distance, Δx , for Accropode and Core-loc units, or in terms of a percentage of the required number of units per unit area, $N = N_u/A = \phi/D_n^2$, which is sometimes also called *relative packing density (coefficient)*; see Sections 3.5.1 and 3.12.

Care is required at boundaries where rocking and free movements are likely to occur. Because of the risk of breaking of the units, these phenomena should be avoided. Contact with neighbouring structures (such as the crown wall) is required and can be difficult to achieve. Accropode and Core-loc techniques use a special placement procedure to guarantee this contact irrespective of the tolerances. Alternatively, an armourstone interface between the concrete armour unit and the structure may be used to ensure contact and interlock (see also Section 6.1.5).

The toe of the armour layer is a very important element in ensuring the stability of the structure. As shown in Figure 6.36, tolerances should always allow a stable base for the lower armour units and take into account any possibility of erosion at the toe of the structure. At the transition between the upper slope of the underlayer and the horizontal berm a low tolerance on required construction profile should be adopted such as + 0.0 m (**above**) and - 1/10 to 1/5 of the thickness of the armour layer (**below** the profile).

6.1.9.3 Construction risks

Construction risks need to be considered at the design stage as there may be opportunities to modify the design to remove or mitigate specific risks. The range of construction risks that may be expected in the hydraulic environment are discussed in Section 9.5. As breakwaters are often constructed in exposed locations, key risks might include use of floating plant or damage to partially completed structures. Insurance of uncompleted works is a significant cost for contractors. Careful planning during design can help to lessen risks, for example by minimising the length of structure not covered by the primary armour, or keeping to the minimum the number and type of construction operations over water.

At exposed sites or in monsoon or hurricane regions it may be necessary to stop or temporarily protect works during the season when weather-related risks are greatest. For large breakwater projects, the use of hydraulic model tests is useful for assessing the impact of storms on uncompleted works.

During construction the underlayer may have to act as a temporary armour layer for the incomplete structure. The hydraulic stability of the underlayer should therefore be verified under storm conditions that might typically be expected to occur during the construction period and a risk analysis study for the construction phase should be performed. Alternatively, a temporary armour layer may be placed, possibly using materials that will eventually be reused as part of the permanent works. Its temporary nature means that it is normally acceptable for some damage of this protection to occur and the requirements for stability performance are greatly reduced compared with those of the permanent works. Highly interlocking armour units are not generally practical for these applications, as removal for reuse is difficult because of the high degree of interlock.

It is recommended that a high safety coefficient is adopted for works to be undertaken in difficult construction conditions (permanent wave action, no underwater visibility or unqualified workmanship).

6.1.10 Maintenance issues that influence design

The requirement for maintenance throughout the design life of a breakwater needs to be considered during the design phase, as this may influence design decisions. When evaluating alternative breakwater options, selection of the preferred option should ideally be based on minimising cost over the structure's lifetime, achieved by selecting appropriate design conditions that balance initial capital cost and maintenance costs during operation (see Section 2.4). This may not always be practical, as other constraints may exist, such as availability of funding for maintenance, availability of appropriate plant and accessibility of the structure. The latter two are particularly important for large breakwater structures where these may not be accessible by land-based plant and may require mobilisation of expensive marine plant, which may not be readily available. Maintenance activities may also have an impact on port operations, such as causing downtime at berths or limiting access when repairs are being carried out. Maintenance is discussed further in Chapter 10.

If the client requires limited maintenance of the structure, standard design methods with an appropriate safety coefficient should be used. This will ensure the probability of failure during the lifetime of the structure is low, so specific consideration of repair methods in the

design process should not be necessary. Conversely, for low-cost structures and those for which the design incorporates lower safety coefficients (eg because the locally available armourstone is limited in size), then allowance should be made in the design for repairs during the structure's lifetime. An analysis of the likely extent and evolution of possible damage should be undertaken to quantify the risk. If the damage is confined and access for repair is possible at a reasonable cost, then the risk may be acceptable. If the damage can spread to an uncontrollable extent, such that the structure may fail before repairs can be carried out, then the risk is generally not acceptable. If the repair implies that other essential parts of the structure are to be dismantled, or a part of the port activities be suspended during repairs, then the risk is probably economically unacceptable.

The breakwater will need to be monitored to identify when and where maintenance works are needed. Monitoring activities require regular access to the structure with measuring equipment. To limit the cost of maintenance of a rubble mound breakwater, a crown wall can be constructed; if the breakwater is connected to the shore, this will allow access by foot or by vehicle.

In some cases access cannot be practically and cost-effectively incorporated into the design; in others it may involve safety hazards, for example where the breakwater is low-crested or not connected to shore. Installation of remote monitoring equipment may be investigated as an alternative. Monitoring involves use of reference points for analysis of changes to the structure. These reference points should be integrated into the structure at the design stage. Where aerial monitoring is to be used, adequate monitoring targets should be integrated into the design. More details on survey methods are given in Sections 10.3.4 and 10.3.5.

6.1.11 Repair and upgrading of existing structures

Repair and rehabilitation of rock structures is discussed in Section 10.5. **Repair** of a breakwater is generally undertaken when the works have suffered damage such that the structure no longer delivers the required performance or is at risk of further deterioration that may compromise the stability of the structure. Rehabilitation generally takes place before significant damage occurs, and so may be considered preventative. Some degree of damage may be acceptable in the structure without deterioration in performance, and often this is taken into account in selection of an appropriate damage level in the design formulae (see Section 5.2.2.2). The need for repairs is normally identified by a risk assessment. Repair of a breakwater does not generally imply revision of the design, although the design conditions should be revisited when designing repairs to ensure these have not changed significantly.

In contrast, **upgrading** generally requires modification of the design – for example, alteration of the structure cross-section, or a change in length of the breakwater, or both. Reasons for upgrading the breakwater design may include increased design life resulting in a change in design conditions (such as sea level rise), or changes in port activities.

Repair and upgrading of breakwaters can be done at various levels:

- simple maintenance that does not generally require removal and handling of a substantial volume of material
- repair involving heavy work and even reconstruction of one or more parts of the external layers of the structure
- rehabilitation and reconstruction of a significant part of the structure
- reconstruction or replacement of the entire length of a breakwater.

In some cases, the decision is taken to abandon part or the entire length of the structure (for example the outer end of the Sines breakwater, Portugal).

From a design point of view, the repair of an existing rubble mound structure is similar to the design of a new structure except on the following points:

- the previous structure has been damaged or has failed or has not been sufficiently robust. Lessons should be learnt from the possible causes of the failure through an analysis of the damaging process and failure mechanism
- the structure already exists and should remain stable during the whole repair works. As part of the armouring may need to be removed, the structure may temporarily be at risk of damage from storms with return periods much smaller than the actual design return period
- the port facilities are in use and interference with the port operation should be kept to a minimum
- land access on the top of the structure is generally much more difficult since wide access for construction works has been removed and may be restricted to final access for light vehicles and pedestrians.

Principles for repair planning are discussed in Section 10.5.1.2, including the data that should be collected for use in planning and designing the repair works. In particular, as-built drawings, updated bathymetry, particularly for soft or highly mobile beds, and storm record data are useful in understanding the causes of damage. A damage survey should be undertaken for use in design of the repair works.

Breakwater repairs may require dismantling of part of the damaged area before the repair is undertaken. Alternatively, for example in the case of a damaged armour layer, the repair layer may simply be placed over the top of the damaged area. Note that repair works to armour layers should always be undertaken by working up the slope. Where concrete armour units are used, there may be scenarios where a different armour unit size is used, for example, when increased mass or stability is required.

Concrete armour unit types are generally not mixed since the stability coefficients of such armour layers are not known, which leads to a high level of uncertainty about the behaviour of the structure. The Core-loc unit was initially invented as a substitute to the dolos for cases where the latter had failed. If damage is localised, the failed armour unit should be removed in entire sections and replaced with the chosen unit. If damage is widespread, the same repair method should apply with the unbroken old units being recovered and reused in an appropriate area.

Sections 10.5.3 and 10.5.4 discuss methods for repair and major rehabilitation of rock structures, which are applicable to breakwaters.

6.2 ROCK PROTECTION TO PORT STRUCTURES

6.2.1 General aspects and definitions

6.2.1.1 Types of structure

Armourstone can be used for the following types of port and marina structure.

- 1 Breakwater structures designed to protect the port from unacceptable wave and/or current action (discussed in Section 6.1).
- 2 Armoured revetments to prevent erosion of material from banks or bunds that provide land protection, eg for reclamation (discussed in Section 6.3).
- 3 Protection to quay, pier and dolphin structures designed to allow ships to berth and the loading/unloading of goods, passengers and vehicles. Within ports, hydraulic loads on structures are generally dominated by vessel-induced waves and propeller-induced velocities. Types of protection include:

- a **slope protection** on embankments, including those beneath open-piled quays
- b **toe protection** to vertical quays and some types of pier to prevent loss of material that would reduce the stability of the structure
- c **bed protection** in front of vertical quays and armoured slopes, or around piles of piers or dolphins to prevent bed erosion and to protect the volume of soil providing passive resistance
- d **rock bunds** under gravity wall structures to form a levelling layer to overcome variations in the bed level, or to distribute high toe bearing pressures from the wall to the bed, and/or to reduce the height of the wall structure to form an economic wall design.

Section 6.2 discusses works under categories 3a to 3c above. These types of protection are intended to resist hydraulic loadings, to maintain the stability either of the vertical structure or of a sloping embankment. Category 3d is not explicitly discussed in this section, but the principles are similar to those for horizontally composite caisson breakwaters, discussed in Section 6.1.7.

When a sloping embankment is subjected to scour it can cause the bank line to retreat. Scour may also cause over-steepening of the slope that may lead to global sliding failure.

Scour in front of vertical structures (eg quay walls) can cause instability of the structure by the following mechanisms:

- loss of soil from below gravity structures, resulting in instability (sliding, overturning etc) and/or settlement
- loss of the soil wedge in front of retaining walls that contributes to stability of the structure (by providing passive resistance), resulting in horizontal deformation or displacement of the wall
- loss of soil from behind retaining walls, resulting in settlements behind the wall, which may lead to sudden subsidence. This loss of soil can occur as a result of:
 - clutch failure during construction of sheet-piled walls, which was not detected at the time of construction
 - piping underneath the wall (see Section 5.4.3.6), triggered by the shorter flow path from the lowest point of the wall to the bottom of a scour hole.

Typical rock protection works to different port structures are shown in schematic cross-sections in Figures 6.37 to 6.39. It should be noted that for sheet-piled quay walls that rely on a passive soil volume a wide bed protection is required; see Figure 6.39. This is discussed further in Section 6.2.3.3.

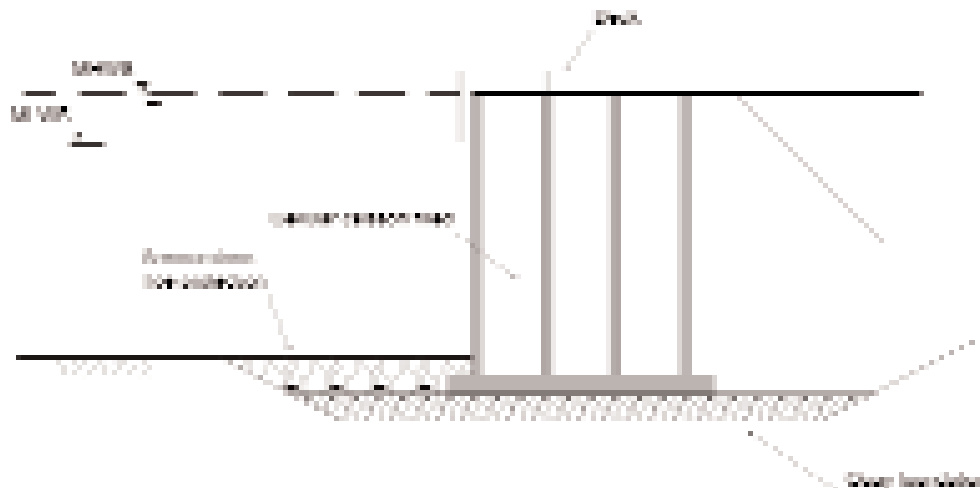

Figure 6.37 Rock protection to toe of vertical gravity quay wall

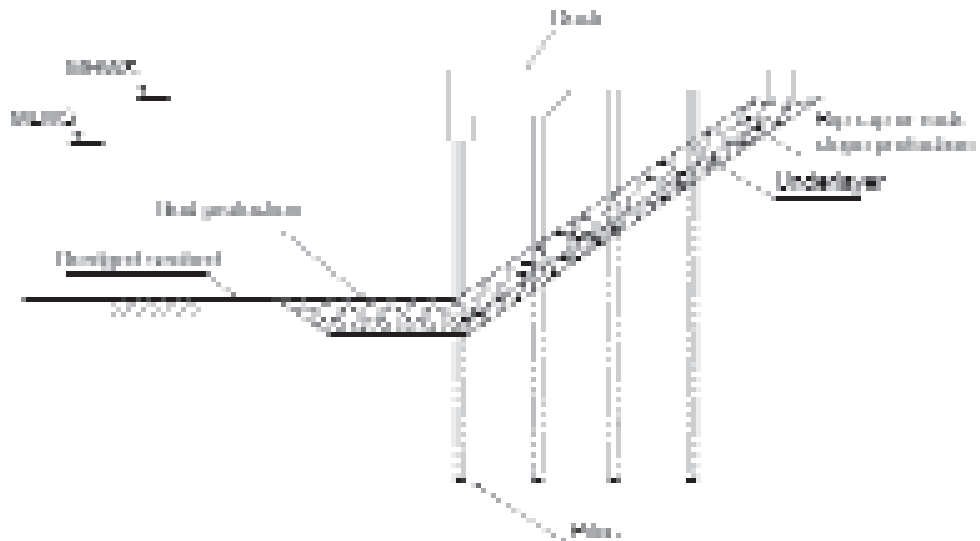

Figure 6.38 Rock protection to slope beneath an open-piled quay wall

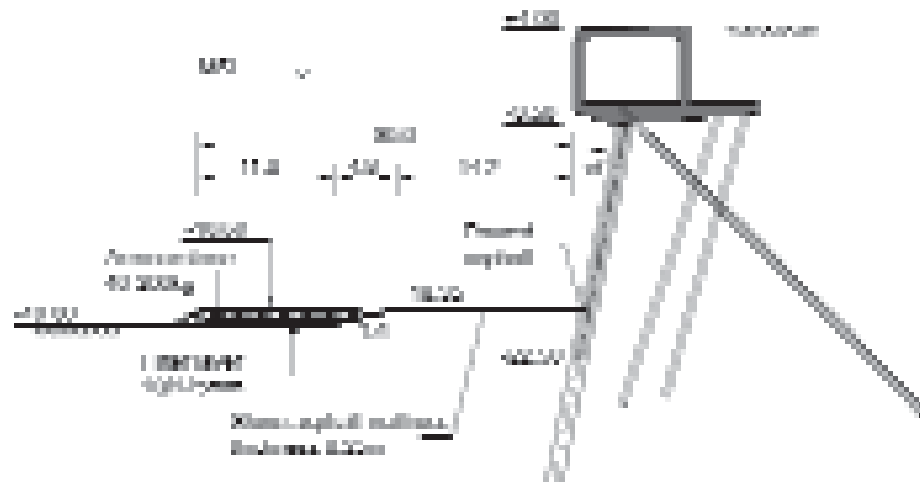

Figure 6.39 Sheet-piled quay wall with rock bed protection (Amazon harbour, Rotterdam)

6.2.1.2 Key properties

When designing rock protection works to port structures, the following issues may need to be considered:

- resistance to wave and current attack, both natural and ship-induced
- resistance to hydraulic loads caused by main propellers and thrusters (bow and stern)
- permeability to allow water to flow in the armourstone layer resulting from changing pore pressures
- prevention of loss of underlying material
- capability of being installed and maintained under water
- flexibility to adjust to settlement
- resistance to movement after placement (either sliding or dislodgement)
- mechanical strength to resist accidental impacts
- constructability including temporary site exposure conditions
- ease of repair after being damaged by extreme events
- durability in service
- value for money.

1

2

3

4

5

6

7

8

9

10

Not all of these properties will be essential in every situation; for example, in some situations it may be acceptable that protection is not flexible or permeable.

As a starting point for the design, the functional requirements should be set out. The reader is referred to Chapter 2 for a discussion on the issues to be considered.

6.2.2 Plan layout

The plan layout of rock protection works to port structures is normally dictated by the layout of the structures to be protected. The layout of the port facilities is dictated by quay and berth dimensions required to accommodate the design vessels and port operations.

Design information on horizontal dimensions of bed protection to port structures is included in Section 6.2.3.3.

6.2.3 Cross-section design and structure details

6.2.3.1 Design loads and armourstone size

To design rock protection works, the hydraulic loads need to be quantified (Chapter 4) for use as input into design equations (Chapter 5). The key hydraulic loads are discussed below.

Waves

Three sources of waves need to be considered for the design of port structures:

- waves generated in deep water and propagated into the port (see Section 4.2.4)
- locally generated wind waves (see Section 4.2.4)
- waves induced locally by ship movements (see Section 4.3.4).

All three types of waves can be important, depending on the local situation and harbour characteristics. Wave loads are often most critical on the upper part of slopes (around and just below the water level).

The derived wave conditions can be used in design formulae in Chapter 5 to determine stable armourstone sizes. The relevant sections of Chapter 5 are as follows:

- armour stones or concrete armour units on slopes – Sections 5.2.2.2 and 5.2.2.3
- toe protection – Section 5.2.2.9
- bed protection – Sections 5.2.2.5 and 5.2.2.9.

Currents and water level variations

Two types of current action should be considered in design:

- currents generated by tides or river flow or by waves breaking (Section 4.2.3)
- currents caused by ship movements (Section 4.3.4).

Wave-induced and tidal currents are relatively small in enclosed harbour basins (< 0.5 m/s), but they can be more important for harbour structures along banks of rivers or estuaries (currents up to about 1.5 m/s). Return currents around moving ships can also be in the order of 1 m/s (strongly depending on the cross-sectional area of the fairway and the distance from the ship).

The design current velocities derived from the relevant sections of Chapter 4 as identified above should be used as input to equations in Section 5.2.3 to determine the required stable armourstone size, as follows:

- armour on slopes – Section 5.2.3.1
- toe protection – Section 5.2.3.3
- bed protection – Sections 5.2.3.1, 5.2.3.2 and 5.2.3.3.

Water level variations caused by tides or passing ships may also need to be considered, particularly for geotechnical design; see Section 5.4.

Propeller and thruster jets

In the vicinity of ship berths, propeller jets are usually the dominant current loading, with velocities up to about 5 m/s and a high turbulence level. Propeller jets generally cause the greatest impact if they are directed from a short distance perpendicular to a vertical wall or a sloping bank.

Jets of bow thrusters are usually directed perpendicular to quays (vertical or open piled). Main propellers can also be directed perpendicular to quays. This can be the case for ro-ro and ferry berths, at the landward end of jetties and in corners at the end of quay walls.

Attack by propeller jets can be severe in the following scenarios:

- in front of ro-ro and ferry berths, as ships moor and unmoor very frequently, always in exactly the same position, without the use of tugs and often with the main propellers directed against a vertical wall or a bank below the stern
- in front of quay walls for container vessels, as these ships often moor and unmoor without use of tugs or with only limited use of tugs, using their bow thrusters under relatively high power
- near quay walls and mooring structures for inland vessels, because such vessels can have relatively large bow thrusters, the outflow opening of which can be very close to the bottom or the bank
- when ships are moored with the stern directed to a bank or quay wall.

It can be assumed that thrusters are used at full power during berthing manoeuvres. It is unusual for main propellers to be used at full power except in the case of ferries. More information on power during berthing manoeuvres is given in PIANC (1997) and EAU (1996).

Guidance for predicting propeller jet velocities is given in Section 4.3.4.3. Methods for deriving the required stone size for stability against propeller jets are given in Section 5.2.3.1.

6.2.3.2 Vertical dimensions

The minimum required thickness of the protection is determined by the hydraulic loading and the required stable armourstone size, determined using the guidance in Section 6.2.3.1.

The maximum thickness that can be constructed is determined by the vertical space available between the contract depth and the construction depth, taking into account tolerances in dredging level, the thickness of the bottom protection and survey accuracy (see Figure 6.40).

The **contract depth** at the quay is the minimum water depth required for berthing vessels (see Figure 6.40), taking into account a required minimum underkeel clearance for the range of vessels and operating conditions (eg lowest water level and wave climate). The contract depth is generally specified by the operator.

The **disturbance level** is the level to which the cohesion of the soil is disturbed by dredging. The indicated dredging tolerance level is the lowest acceptable level of the harbour bottom after dredging. Spill of material during dredging means the dredging tolerance level is higher than the disturbance level.

The **construction depth** is the upper level of the volume of passive soil that is needed for horizontal geotechnical stability of the quay structure (see Figure 6.40). During construction of bed protection, the construction depth can be larger than during full operation of the quay if the vertical load on the quay is smaller than the design load for full operation of the quay.

The thickness of the bed protection may be a critical factor for the design. Where available, thickness reduction may be achieved by using armourstone with a higher density or by using artificial materials, such as concrete or recycled or secondary materials, discussed in Section 3.13. Some of these materials may be attractive from an environmental point of view and may require specific study before placing. Other alternative materials that may be used are presented in Section 6.2.4.

An allowance for construction and dredging tolerances also needs to be included.

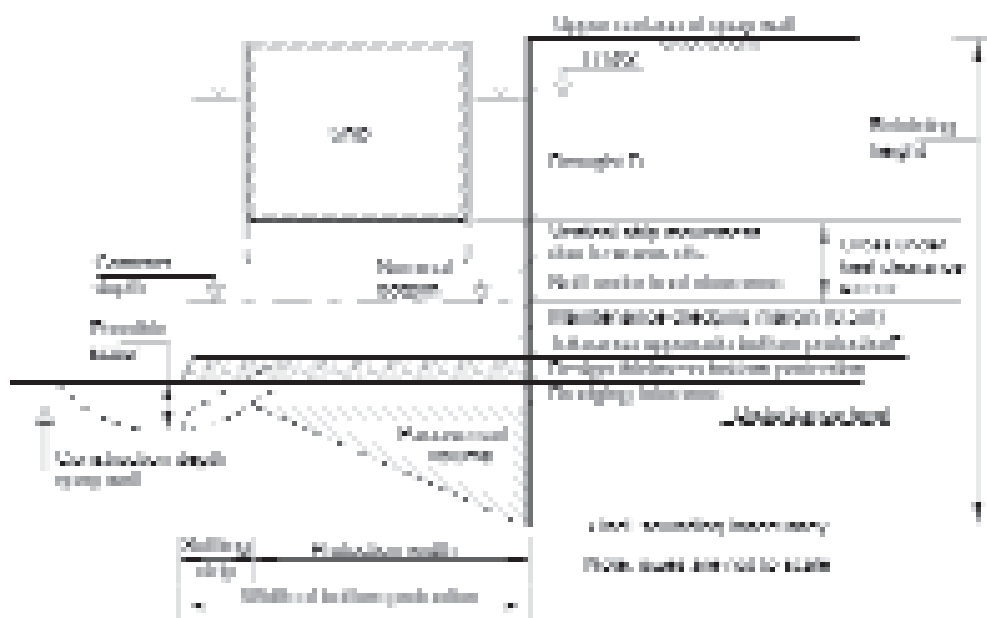

Figure 6.40 Contract and construction depth at quay

Vertical tolerances

There will always be fluctuations in the thickness and the top level of the bottom protection. The statistical standard deviation of the fluctuations in the top level of a bottom protection, $\sigma_{upperside}$ (see Equation 6.1), is the result of a (quadratic) summation of the standard deviation in (1) the upper level of the original bed (after dredging and/or profiling), (2) the thickness of the bed protection and (3) the monitoring.

$$\sigma_{upperside} = \sqrt{\sigma_{subsoil}^2 + \sigma_{thickness\ filter}^2 + \sigma_{thickness\ top\ layer}^2 + \sigma_{monitoring}^2} \quad (6.1)$$

The tolerance values which are applicable for bottom protection works depend upon the acceptable probability of exceedance. If it is accepted that the tolerance is exceeded on 2.5 per cent of the surface, then the tolerance is theoretically equal to two times the statistical

standard deviation. For typical values of the standard deviation, reference is made to Section 9.3.7 and Rotterdam PWED *et al* (2001).

If (local or temporal) sedimentation can occur on the bottom protection, a dredging margin (eg 0.5 m) for removing the sediment by maintenance dredging should be incorporated in the contract depth (see Figure 6.40). Maintenance dredging is a particular issue where berth boxes have been constructed to provide sufficient water depth at berth during low states of the tide, as these are susceptible to silting up.

The protection may experience incidental mechanical impacts caused by ships (at extreme low water levels) or by maintenance dredging. This should not result in failure of the construction.

6.2.3.3 **Horizontal dimensions**

Slope protection beneath open-piled quays

Where rock protection is applied to slopes adjacent to berths, the point where the toe of the slope intersects with the horizontal bed should be set back from the berthing line to ensure that any protruding armourstone or slumping of the slope protection is clear of the hull of a ship with minimum underkeel clearance. A minimum horizontal clearance of 1 m is suggested, but this depends on the size of the armourstone, the irregularity of the slope and the accuracy of placement that can be achieved below water, particularly for greater water depths. Where there is less certainty on the finished profile, then larger clearances should be incorporated in the design.

Bed protection

Bed protection may be used in front of vertical quays and armoured slopes, or around piles of piers or dolphins, to prevent bed erosion and/or the transportation of bed material.

As a minimum, the width of the bed protection next to vertical quays and sloping embankments should be equal to the width of the passive soil volume in front of the structure, enlarged with a strip in which the bed protection acts as a falling toe, following the scour of the adjacent unprotected bed. The width of this strip can be calculated as the product of the expected scour depth and the expected side slope of the scour hole, when covered with a bed protection. Typically a side slope of 1:3 to 1:5 may be a reasonable assumption, although this should be assessed for the particular ground conditions at the site. In this respect, further discussion on falling apron and *Dutch toe* design is given in Section 6.3.4.1.

The cross-section of a vertical sheet-piled quay wall in Figure 6.39 shows that a wide bed protection is required to protect the passive soil volume.

Toe protection

The width of toe protection is mainly determined by the scour depth that is expected next to the structure. Toe protection to quays and piers is typically a minimum of three stones wide for larger stone sizes, such as the standard heavy gradings, ie 300–1000 kg and larger (see Table 3.5). For smaller armour stones (ie light and coarse gradings) a minimum of 1–2 m may be used. As for the outer limit of bed protection, a falling apron may be designed to protect the side slope of any scour hole that develops and to limit further progression of scour (see Section 6.3.4.1 for details on falling aprons).

6.2.3.4 **Slope angle**

For embankments under open-piled quay walls, the inclination of the slope is determined by the geotechnical stability of the fill material, see Sections 5.4.3.2 and 5.4.4.5. For sand embankments, the slope angle is also influenced by the resistance against erosion during construction of the embankment, if the fill material is exposed to waves or currents prior to placement of the cover layer. Stable sand slopes are usually relatively gentle, with typical values of around 1:2 to 1:3, although more gentle slopes of 1:4 to 1:6 may be adopted if the partially completed structure is to be exposed to hydraulic loads. Where the embankment is made of quarry run, erosion in the temporary condition is seldom a problem and slopes may be steeper. The usual choice is 1:1.5, but slopes as steep as 1:1.25, which is the practical limit, have been used.

6.2.3.5 **Armour layers**

Rock protection may either be rip-rap or armourstone (see Section 3.4.3.1). Rip-rap is traditionally used as slope protection for revetments where wave action is low and the effects of currents usually govern the design, so it is widely used for inland waterways and harbours with moderate wave action. Armourstone is generally used in coastal harbours.

Armourstone protection is normally placed in a double layer. The dimensions of the armour layer are given by $2k_t D_{n50}$, where k_t (-) is the layer thickness coefficient depending on the stone shape and placing method (see Section 3.5.1). Guidance on standard gradings is given in Section 3.4.3. Guidance for specifying non-standard gradings is given in Section 3.4.3.9.

For port structures that are subject to high propeller jet velocities, alternatives to rip-rap and armourstone, such as grouted stone and asphalt mats (see Section 6.2.4), may be favourable because they reduce the thickness of the protection required.

Concrete armour units are also used in harbours. Hollow concrete blocks are often used as protection to slope revetments in ports. Such blocks can easily accommodate the relatively low wave action that usually occurs in harbours, and propeller jets acting on the lower part of the slopes. Further discussion on concrete armour units can be found in Section 3.12 and design guidance is presented in Section 5.2.2.3.

6.2.3.6 **Underlayers and filters**

The armour layer is generally placed on a filter or underlayer, to ensure filter criteria are met (see Section 5.4.3.6). The underlayer may also be made of armourstone; alternatively, a geotextile filter may be used. Where space constraints limit the thickness of construction a geotextile can lessen the thickness, but it may be vulnerable to puncture during stone placement if used without a protective stone layer. When used under water, geotextiles should be placed using methods that avoid such difficulties (see Section 9.9.1.2).

In the Netherlands geotextiles are placed under water using a willow mattress (also known as a fascine mattress). This is a flexible mattress constructed of bundles of young willow stems (called *wiepen*), bound together to form a grid of 1 m × 1 m modules, attached to a strong geotextile at the underside. The mattress is sunk into position by loading it with coarse armourstone ballast up to about 100 mm size. A final layer of rip-rap is added as the armour layer. This system is not suitable for slopes steeper than 1:2.5 because of the risk of sliding. When constructed in the dry, short timber stakes can be driven into the slope in order to prevent sliding, although there is a risk of tearing the geotextile at the stakes.

The filter rules given in Section 5.4.3.6 should be checked to determine the grading of a granular underlayer. The transitions from underlayer to armour layer and from the underlying material to the underlayer should be checked.

6.2.3.7 *Toe details and terminations*

Often the termination of bed or toe protection is not outside the zone at risk from scour. In these cases the termination should be flexible to allow deformations resulting from scour of the unprotected bottom, without loss of integrity of the protection. This can be achieved by providing a surplus of material that falls into any scour hole that develops. This may not be possible where depths and hence structure dimensions are limited. The protection can also be extended outside the scour zone, although this results in increased costs.

Preferably the bed protection should be flexible not only at the termination but over the whole area. The advantage of a flexible protection is that it can follow uneven settlements and so can give an early warning (in the form of a subsidence) if loss of bottom material occurs from below the protection (for example as a result of inadequate filtering).

Guidance is given in Section 6.3.4.2 for typical toe details, particularly where constructing in the wet or where scour is an issue.

6.2.3.8 *Transitions and junctions*

There should be a good transition between bed protection and the adjacent vertical structure, so that washing out of the subsoil is not possible. A geotextile, if present below the bed protection, should be wrapped up against the face of the vertical structure and fixed in place, taking care to avoid gaps through which bed material can be lost. This can often be a difficult detail to construct. Stones should be placed carefully (by a crane or chute) within the profile of a sheet-pile wall. Openings between bed protection and the structure can be filled with asphalt or concrete (see Section 8.2.7.6).

At transitions between slope protection and the unprotected bottom, flexible elements should be used, particularly when more rigid forms of slope protection are used, eg grouted stone (see Section 6.2.4). This will prevent scour of the unprotected bottom that may cause underwashing of the more rigid armour layer.

Transitions between rock-armoured slopes (and revetments armoured with concrete units) and rigid structures, such as quay walls, crown walls etc require special attention. Such junctions are prime locations for initiation of damage when the concrete surfaces are smooth. Provisions for keying-in (eg profiling of concrete surface) should be included to ensure that the armour units are kept in place.

6.2.3.9 *Crest details*

Crest details for slope protection may be similar to those given for coastal revetments in Section 6.3.4.2. Where the slope protection is beneath a piled deck, however, space constraints may mean that alternative details are required. The junction between the top of the rock armoured slope and the piled deck is often vulnerable to damage due to concentrations of wave energy at this location. Typical forms of damage include loss of stones, settlement and damage to quay structures due to waves slamming on the underside of the deck. A robust detail is therefore required to prevent progressive failure of the armourstone slope or damage to the deck above. The following recommendations are given for detailing at the crest of slopes beneath quays:

- sheet piling or a downstand beam should be provided behind the rubble slope to prevent loss of fill material should damage to the armour layer or settlement of the slope material occur
- larger armourstone protection may be used at the top of the slope as this is the region of highest potential instability

- vents or other openings may be provided in the deck that extends over the slope to allow release of wave pressures that build up as air is trapped at the transition between deck and slope
- the geometry of the beams should be carefully designed to deflect waves and avoid corners where waves can become trapped and cause increased loading.

6.2.4 Alternative materials

The section concentrates on the use of armourstone for protection to port structures. Alternative materials that may be used in port protection works are summarised here:

- grouted stone
- gabions
- prefabricated asphalt mattresses
- concrete blocks, linked together by cables
- grout-filled mattresses.

Grouted stone

Grouting of relatively light armourstone (eg 5–40 kg or 10–60 kg) can be applied to withstand large hydraulic loadings in situations where the vertical construction space is too small for placing larger armourstone or in situations where armourstone or rip-rap of the mass required for stability is not available. The permeability can be retained by applying so called *pattern grouting*. This requires considerable skill, particularly when carried out under water. If *full grouting* is applied, either the mass of the grouted layer should be enough to withstand water pressures underneath the layer or a filter layer or drainage system should be made to avoid pressure building up beneath the cover layer. Grouting may not be suitable for slopes as steep as 1:1.5. Design guidance is provided in Section 5.2.2.7.

The grouting material can be (colloidal) concrete or asphalt. Colloidal concrete is generally much cheaper than asphalt, but has the disadvantage of being rigid. Asphalt, on the other hand, has a certain plasticity and this can follow slow deformations of the subsoil.

When grouting with colloidal concrete or asphalt is applied on a slope, the composition of the grout should be chosen carefully: if the grout does not have enough stiffness, it will flow down the slope. Also careful control procedures are needed during construction.

Grouted materials are discussed further in Section 3.15. The PIANC recommendations for inland waterways (PIANC, 1987) include detailed design guidance.

Gabions

There are few references to the use of gabions in bed protection (Dossche *et al*, 1992). Gabions may be at risk of failure at the edges, where the high water velocities can cause them to roll up. As it is difficult to pack gabions tightly with stones there is a danger that, under wave conditions, rocking of individual stones may abrade the wire. Gabions can also fail when the mesh wire is damaged by corrosion (especially in salt water if it is metallic), wear (eg by suspended material in flowing water) and mechanically (by ships or dredging work, for example). Gabions are discussed further in Section 3.14 and design guidance is provided in Section 5.2.2.7.

Prefabricated asphalt mattresses

Prefabricated asphalt mattresses are relatively expensive, but they may provide suitable bed protection in scenarios where a minimal construction thickness is required that can withstand

relatively large current velocities. They are generally 150–250 mm thick and consist of an open stone asphalt mattress attached to a geotextile. Special attention should be given to the permeability of the mattresses and to the ensuring all edges are suitably fixed. Openings between mattress and quay wall and between adjacent mattresses should be carefully filled with asphalt grout or asphalt mastic. The edge of the mattress adjacent to the unprotected bed can be fixed by sufficiently large armourstone (for example as shown in Figure 6.39). The PIANC recommendations for inland waterways (PIANC, 1987) include design guidance.

Stone asphalt mattresses can be made at the construction site, so that the mattresses can have large horizontal dimensions (10 × 20 m) resulting in a minimum of openings between placed mattresses.

Concrete blocks, linked together by cables

Concrete blocks linked together by cables can also be used to make a thin protection that can withstand large current velocities (Pilanczyk, 1998). After positioning, connections should be made between adjacent mats to ensure integrity. Filling the openings between block mats is more difficult than filling the openings between asphalt mattresses.

Grout-filled mattresses

Synthetic fabric mattresses filled by grout may be used as an alternative material. The reader is referred to PIANC (1997) for detailed guidance on use of such mattresses.

6.2.5 Cost aspects

General cost considerations for rock projects are discussed in Section 2.4. Particular cost considerations for port structures will relate to the balance between initial capital cost versus maintenance costs, including the economic impact for the port of downtime at berths due to maintenance. For example, when building a new quay wall, there are various scenarios for averting the risks connected with scour:

- 1 No bottom protection is applied; limited scour is accepted; frequent monitoring is needed.
- 2 A *light* granular bed protection is applied; limited scour is accepted; frequent monitoring is needed.
- 3 A *heavy* bed protection is applied; no scour or damage to the protection is accepted.
- 4 No bed protection is applied, while (a) the length of sheet piles or (b) the total foundation depth of the quay wall is increased to accommodate the expected scour depth.

When choosing one of these scenarios total life-cycle costs should be taken into account (see Section 2.4.1). In doing so it is important to ensure that regular maintenance during operation is a practical option, in terms of access to the structure and impact on operations of the facility.

Scenario 1 can be favourable where there is a large under-keel clearance and bow thrusters have only a small impact, where design load occurs very occasionally or where the bed material is not prone to high erosion. Scenario 2 can be favourable if the design load does not occur frequently at the same location. Scenario 4b allows the potential for a future increase in the water depth in front of the quay wall.

6.2.6 Construction issues that influence design

The practicality of construction needs to be considered during the design process. Further detailed discussion of construction issues is given in Chapter 9, and in particular Section 9.9.1.2, which discusses construction of bed protection. This section discusses the key construction issues that could influence the design of rock protection works in ports.

One of the key factors for port works is the phasing of construction works, as this may influence the degree of shelter for executing the construction works. For example, is the structure in question protected by a breakwater during its construction or is the construction programme such that the breakwater will exist only after the quay/jetty/revetment is constructed, meaning that loading during construction will be greater than in-service loads? The protection should be designed taking into consideration the most severe loads, whether during or after construction.

For rock protection to slopes the following construction sequence is recommended:

- lay bed or toe protection first, to provide support to the slope protection
- place underlayer and armour on the slope, by working up the slope from the toe, ensuring good placement and interlock.

Where slope protection is constructed beneath a piled deck, the following alternative construction options are possible.

- 1 Drive piling through the embankment, then place slope protection.

In this approach it is important to prevent movement and possible damage to the piles. Before placing the slope protection, it is recommended that the pile heads are securely braced, either with temporary works or by casting some of the permanent deck beams.

- 2 Place slope protection and then drive piles.

Piling through the stone protection needs to be done with care as the piles can be knocked off their alignment and the ends can be damaged. Usually it is possible to drive open-ended piles through material up to 100 mm diameter, although in most cases this will be smaller than the cover layer armourstone.

Temporary openings or sleeves may be incorporated in the rock protection using pipes or tubes through which piles can be driven once construction of the slope protection is complete. Temporary caps may be placed on these openings during placement of the armourstone. To prevent them moving down the slope these openings may have to be temporarily restrained, for example by using steel wire ropes secured to anchor blocks at the top of the slope. To complete the protection, the gap between the pile and sleeve should be filled with sand/cement bagwork.

There may be financial risks if different contractors are responsible for the slope protection works, for example as part of a reclamation contract, and the construction of the piled structure. Preferably, these works should be integrated to ensure that piling and construction of the slope and protection beneath the deck can be co-ordinated and completed before completion of the deck structure itself. Often the water level is very close to the underside of the deck in the completed works, so access to complete construction or remedial works on the slope is difficult once the deck structure is in place.

Material over 500 kg is difficult to place properly on a slope by dumping with a grab and usually represents the upper limit of rip-rap. Above this limit, individual placing of armourstone is required.

If the alternative materials discussed in Section 6.2.4 are applied under water, then generally more diving work is needed compared with placement of armourstone or rip-rap.

Geotextiles may have to be used to ensure filter criteria are met, where it is not practical to do so with granular filters only, for example because of space constraints. It may be necessary to restrain the geotextile by, for example, fixing concrete blocks, fixing the geotextile to fascine mattresses or using divers to load the geotextile with stones at intervals. Further discussion on the use of geotextiles is given in Sections 6.3.3.6 and 9.9.1.2.

If construction of toe or bed protection requires excavation, care should be taken to ensure that no siltation occurs before the protection is positioned. Placement operations should follow as soon as possible after dredging. It may be appropriate to undertake the work in strips to avoid leaving large excavations open for prolonged periods.

6.2.7 Maintenance issues that influence design

Interim monitoring and condition inspections may be undertaken by port operators to inform the need for maintenance of infrastructure. Monitoring and maintenance of rock protection works in ports is often difficult as the structures are generally under water or difficult to reach, such as under piled jetties or at berths that are in constant use. Monitoring and maintenance requirements may lead to downtime at the berth, with economic implications.

It may therefore be preferable to develop a design with a larger armour size than anticipated to avoid the need for maintenance. This may increase the capital cost to the operator, but will cut maintenance and downtime costs over the structure's lifetime. If the armour is to be increased in size, then the implications for construction thickness and the need for excavation will need to be considered. Degradation models for prediction of the decrease of armour size over the design life are discussed in Section 3.6.6.

For steel-piled jetties there is a design issue relating to accelerated low water corrosion and the provision of cathodic protection to prevent this condition. The design will need to permit access for inspection and replacement, particularly for areas that are difficult to access such as piles at the top of a rock-armoured slope.

Monitoring and maintenance of rock structures are also covered in Chapter 10.

6.2.8 Repair and upgrading

Rock protection to port structures may be added at a later stage in the design life of a pier or quay as part of repair or upgrading works, to provide protection as a result of problems of scour or bank damage that may compromise structure stability. Existing rock protection works may also require repair and upgrading, perhaps because the design was inadequate, or to accommodate changing requirements or uses at the quay that have increased the loading on the rock protection.

Repair and upgrading are predominantly underwater tasks. The key issue is to establish whether the armourstone can be placed from above or whether the armourstone is to be removed and replaced under a jetty structure. It would be very expensive to try to lift armour stones into locations below a jetty deck. Cheaper and more practical solutions may therefore need to be considered for repairs, such as pumping concrete into permanent formwork to provide a more rigid protection.

Where existing structures need new rock protection, care should be taken that any excavation to accommodate the new works does not compromise the stability of existing structures.

Repair and upgrading is discussed further in Section 10.5.

6.3 SHORELINE PROTECTION AND BEACH CONTROL STRUCTURES

Shoreline protection (or coastal defence) and beach control structures built of and/or armoured with stones have a number of benefits when compared with other materials and forms of construction. Table 6.4 below summarises both the advantages and disadvantages of using rock in such structures. The designer should appreciate the limitations of the form of structure that they are considering. This section aims to relate these limitations and considerations to the designer in the form of practical guidance.

Table 6.4 *Advantages and disadvantages of rock structures for shoreline protection*

Advantages	
Durability	Rock from most sources withstands wear and attrition sufficiently and is ideally suited to the coastal environment.
Wave absorption	Porous and generally have gently sloping faces, so readily absorb wave energy and minimise adverse scour consequences caused by vertical reflective surfaces of seawalls and other structures.
Flexibility	Readily modified to take account of changing environmental conditions.
Cost effectiveness	Can be cost effective, eg using locally available materials.
Visual impact	Often considered visually attractive compared with other forms of sea defence, for example large seawalls or concrete stepped revetments.
Ease of construction	Even with limited equipment, resources and professional skills, structures can be built that function successfully.
Settlement	These are flexible structures that can adjust to settlements and are only damaged in a modest way if the design conditions are exceeded.
Maintenance	Repair works are relatively easy and generally do not require mobilisation of very specialised equipment. If properly designed, damage may be small and repairs may only involve resetting of displaced stones.
Disadvantages	
Safety	Concern over access to structures and risk to members of the public from falling into and being trapped in voids.
Navigation	Long rock groynes may cause problems for navigation of small leisure craft and fishing vessels. Groynes and breakwaters may need to be marked with appropriate lights or marker beacons. Submerged rock structures can be considered a navigation hazard if located near busy shipping lanes or areas of high amenity usage.
Footprint on foreshore	Rock revetments and rock groynes take up more foreshore than vertical seawalls and timber groynes respectively. This may be a consideration if the foreshore has environmental designations. Access limitations due to beach levels for maintenance may also mean that rock structures are not suitable at certain locations.

This section concentrates on the features and design considerations for seawalls, shoreline protection structures and beach control structures that differ from those of breakwaters. Cross-reference is made to Section 6.1 on breakwaters where appropriate. The section covers a range of structures, from revetments and anti-scour mats to structures designed to retain sand or gravel beaches, including conventional and fishtail groynes as well as offshore (or detached) breakwaters and sills.

Guidance on the selection of protection concept and layout, armouring systems and structural details is given. Cost, construction and maintenance issues that influence the design are also discussed, with cross-reference to the relevant sections of Chapters 9 and 10 where necessary.

The concept generation, selection and detailing of a rubble mound breakwater can be summarised by the flow chart in Figure 6.41. The numbers refer to the relevant parts of this section.

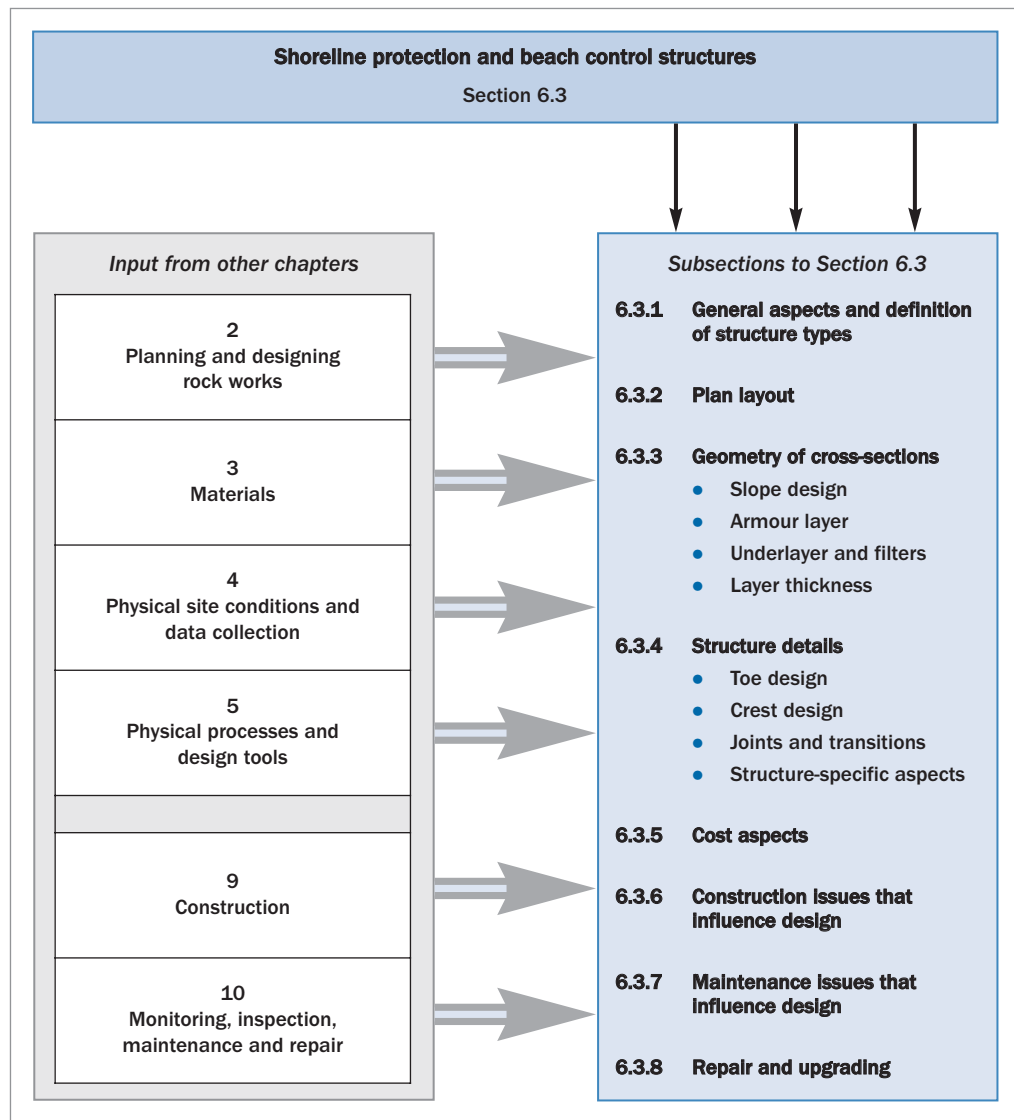

Figure 6.41 Flow chart for guidance on design of shoreline and beach control structures as presented in this manual

6.3.1 General aspects and definition of structure types

Rock structures used in coastal and shoreline engineering generally have components similar to those of breakwaters described in Section 6.1. However, they may frequently only have two gradings of armourstone in them because of their more modest proportions. For this reason, unless the structure is large enough to be described as a breakwater, the outer layer is generally known as the armour layer or cover layer rather than the primary armour layer; the underlying armourstone layer is referred to as the underlayer, bedding layer or core. If a third material is used in rock structures for coastal defence purposes this often tends to be rather fine, such as sand, clay or other cliff or beach materials, generally used as fill to achieve the required profile.

Coast protection rock structures often differ from breakwaters in that they may form part of a system, working together with other components to provide the required function, for example rock protection to a seawall or rock groynes as part of a beach recharge scheme. This may mean that damage to the rock structure will not result in catastrophic failure, which can be taken into consideration in the design. Research in the UK has considered examples of low-cost rock structures around the British coast that depart from standard design guidance (Crossman *et al*, 2003). The report identifies opportunities for deviating from standard guidance to produce low-cost rock structures. According to the report,

advantages include easier construction, improved construction safety, reduced environmental impact and greater adaptability. The design changes may include reduction in armour sizing, elimination of filter layers, use of lower-quality rock available locally or minimisation of excavation (see also Box 6.10 in Section 6.3.5). These design changes will result in an increased maintenance requirement over the project life. It is important at the outset that the owner understands and accepts the design basis and long-term maintenance requirements. Case study examples are discussed in Chapter 10.

The following types of rock structure are discussed in Section 6.3:

- revetment
- scour protection
- groyne
- detached (or offshore) breakwater
- fishtail breakwater
- L-shaped and T-shaped groynes
- sill or submerged breakwater.

6.3.1.1 **Revetment**

A revetment is a cladding of stone, concrete or other material used to protect the sloping surface of an embankment, natural coast or shoreline against erosion. Armourstone may be used either alone or with stability improvement (asphalt, pitching, gabions, mattresses etc). Revetments may be used for protection of cliffs, sand dunes, reclamation, and existing seawalls requiring repair or renewal. Figure 6.42 shows a typical rock revetment during construction, showing the double layer of armour and the underlayer, placed on sand material.



Figure 6.42 Rock revetment, Hurst Spit, UK (courtesy Andrew Bradbury)

6.3.1.2 **Scour protection**

Scour protection comprises one or more layers of stones placed in front of an existing seawall, cliff or sand dune, normally placed at a small angle, to prevent further undermining of the toe of the basic coastal defence structure. It is often used in conjunction with an overlying beach or dune nourishment scheme. In this case, the scour protection is provided to guarantee the integrity of the coastal defence structure in an extreme storm situation when the beach material may be temporarily removed, before milder wave action allows it to recover. Figure 6.43 shows a location where stones have been used as scour protection at the foot of a concrete seawall.



Figure 6.43 Scour protection to seawall, Happisburgh, UK (courtesy Halcrow)

6.3.1.3

Groyne

A bastion groyne is a relatively short rock structure running seawards from the beach head, whose primary function is to interrupt the longshore transport of sediment in order to build or retain higher beach levels (and often thereby to protect an existing coast defence structure). Historically rock groynes have been around 50 m long, but **terminal groynes** at the end of a long ungroyned beach can be longer. A related type is the hammerhead or boot groyne, which retains sediment in the lee of the groyne by means of wave diffraction around the groyne head. Figure 6.44 shows a simple rock groyne. In many circumstances the detail and form may be more complicated, and the designer should consider the construction aspects of using complicated designs when designing the structure form.



Figure 6.44 Typical rock groyne (courtesy Halcrow)

6.3.1.4 *Detached breakwater*

Detached breakwaters are generally surface-piercing (at least for most of the tidal cycle) and lie approximately parallel to the shoreline. Their function is to reduce wave activity and encourage beach build-up at the shoreline in the lee of the structure. Sediment is transported into the lee of the breakwater by wave diffraction-induced currents. Such breakwaters generally have a length similar to their distance offshore, which is typically 200–300 m, although sometimes local conditions require smaller structures (see also Section 6.3.2.2). Figure 6.45 shows a typical layout of detached breakwaters on the south coast of the UK. Rather than acting as a barrier to trap the sediment as groynes do, offshore or detached breakwaters create a zone of reduced wave energy behind them in which sediment is deposited, producing crescent-shaped beaches between adjacent breakwaters. Isolated breakwaters may be particularly useful in protecting lengths of coast where erosion occurs because the net longshore transport rate is higher than elsewhere. Ideally the construction of an offshore breakwater will reduce the net longshore transport rate so that it is similar to that of adjacent coasts.

Detached breakwaters can be used purely for amenity purposes to create and hold an amenity beach in locations where the coastline does not allow this to occur naturally. Such situations should be the subject of considerable study and physical modelling to ensure that structures are appropriately sized and located.



Figure 6.45 *Detached breakwaters, Elmer, UK (courtesy Environment Agency/Arun DC)*

6.3.1.5 Fishtail groyne

Fishtail groynes combine the features of offshore breakwaters with the conventional barrier function of groynes. Fishtail groynes may also be referred to as a type of artificial headland. They may be used in conjunction with beach nourishment to create sandy amenity beaches. Typically, these groynes may extend 200–300 m offshore. A typical fishtail groyne is shown in Figure 6.46, which illustrates beach material accumulating in the lee of the arms.



Figure 6.46 Fishtail groyne (courtesy DEFRA/Halcrow)

6.3.1.6 L-shaped and T-shaped groynes

L-shaped and T-shaped breakwaters are precursors of the fishtail breakwater that can be used to form artificial headlands. They are often used in situations where the tidal range is small (eg the Mediterranean) to create pocket beaches, generally of sandy sediment. Figure 6.47 shows a small L-shaped groyne used to hold a gravel (or shingle) beach within a bay.



Figure 6.47 L-shaped groyne, Bulverhythe, UK (courtesy Halcrow)

6.3.1.7 Sill or submerged breakwater

Sills or submerged breakwaters are used to retain a beach of relatively mild slope on an existing, possibly steeper sloping foreshore. Sills have been employed most successfully in situations where the tidal range is small. They can be used in conjunction with L- or T-shaped groynes or full-height offshore breakwaters to retain pocket beaches. They trigger the breaking of the larger (most destructive) waves, but have little effect on normal day-to-day activity, so that recreational aspects of the beach are not diminished. Figure 6.48 shows a typical arrangement of a submerged sill creating a perched beach.

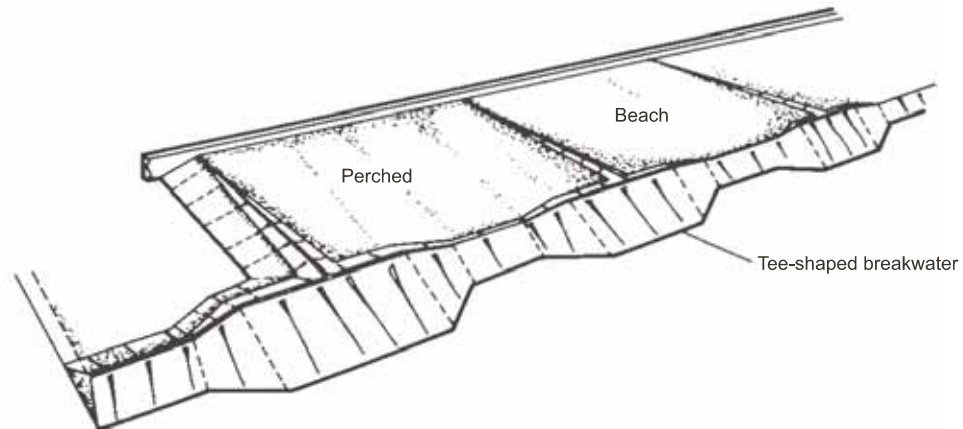

Note: This concept is applicable where tidal range does not exceed about 1.0 metres.

Figure 6.48 Perched beach with submerged breakwaters

There are potential health and safety implications of adopting such a layout, which include members of the public walking out across the perched beach and into the deep area of water seaward of the breakwaters. Signage and markers are essential. Boats and other leisure craft are also at risk from striking the submerged components if they come too close to the structure. Again, appropriate marking of the structure is required.

6.3.2 Plan layout

6.3.2.1 General layout considerations

The plan layout of a coastal or shoreline defence structure depends on its required function, planning policy decisions regarding the overall line of the coast, physical site conditions, and any assets to be protected. The current legislation and the interrelation with adjacent shorelines, amenity and environmental requirements and benefit-cost considerations are also important factors to consider. The layout design is also significantly influenced by the choice of material. For example, local availability of rock material can provide the client with a cost-effective solution. In general, the following considerations will dictate the form and plan layout of structure used:

Position of shoreline

The starting point to determine the plan layout of a rock coastal defence structure (given the functional requirements for the system) should always be the existing shoreline, or the possible shoreline position if realignment is to be allowed. The position of the defence structure on the shoreline is defined by the beach contours and is often taken as the high water mark. By undertaking topographical surveys and assessing historical charts and surveys the position of the high water mark can be established. It is often important to look at historic trends for the position and aerial photographs, charts and surveys can be very useful for this purpose.

The position of the low water mark is important too particularly for design of the structure toe, and the gradient from low to high water marks should inform the design of the structure length and height. Similar techniques as described above can be used to determine the position of low water.

A cautionary note is that often on charts and old surveys or drawings the position of low water and high water are incorrect because of foreshore level changes and should be treated with caution. This is perhaps the most valid reason for commissioning an up-to-date survey of the foreshore.

Other coastal forms such as sand dunes, cliffs and foreshore banks are also important in defining the shoreline. An existing seawall often defines the shoreline, but this may no longer represent the shoreline's natural position if the seawall has been constructed on a coast that is naturally eroding or accreting.

Policy

Given the existing shoreline or line of defence, the relevant authority or regulating body may have defined a policy option for management of the coastline. It is therefore important that the particular policy of the country in which the work is located is investigated. Depending on the circumstances, certain considerations may outweigh others. For example, environmental designations at a site may mean that some technical options are not suitable so other forms of structure will have to be considered. The policy in relation to shoreline position will generally be one of the following:

- withdrawal (retreat), providing new set-back sea defence flood banks where necessary for safety
- selective erosion control, maintaining the existing defence line at key locations
- full erosion control, maintaining the existing line of defence
- seaward expansion (advance), creating more land or beach.

Selection of the appropriate policy option will be influenced by factors that include adjacent land use, impact on coastal processes for adjacent lengths of coastline and benefits and costs.

Where residential or industrial land lies behind the shoreline it is generally possible to justify maintaining the existing line or indeed to advance it by means of reclamation.

Where the land is agricultural, the value is rarely high enough to justify defending the existing shoreline, unless it is low-lying and a flood defence bank is involved. Thus the defences of a coastal town may be maintained while adjacent agricultural land is allowed to erode (selective erosion control).

Each country's government policy will affect the decision to protect a section of coastline or not and these need to be determined at the outset of the planning stage.

When designing rock structures, the designer should remember that there will be influences updrift and downdrift of the area for which the structures are being designed, unless this area is a complete and closed coastal process cell. The design of revetments and scour mats will also have an influence on the beach in front of the structure.

Other considerations

While the considerations identified above in this section are important, the effects of the structure on the local economy and environment should not be overlooked. A rock structure can have a wider impacts than one may at first imagine, for example:

- any new rock structure may affect the local fishing fleet's access to fishing grounds and may be considered a danger to navigation in the adjacent waters
- leisure craft may be affected in the same way as fishing vessels, as current changes, underwater obstructions (including submerged breakwaters), perched beaches and access limitations may constitute navigation hazards
- amenity safety needs to be addressed if the structures are close to busy public areas. There is a perceived risk that people climbing on these forms of structures could become trapped within the voids between the armour units
- navigation is a major issue, especially when locating offshore breakwaters and large groyne. Charts need to be updated and the structures should be appropriately marked
- the impacts of Sea Level Rise (SLR) and climate change should be taken into account. Various figures for SLR are published around the world and the designer should refer to these for guidance on the allowances to be taken for the individual countries or locations under consideration. Increased water levels resulting from SLR will also mean larger waves will act on the structures towards the end of the design life. These need to be allowed for when designing for overtopping and stability
- environmental designations often determine the form of structure to be installed. Foreshores are often designated under various types of legislation and these restrictions need to be considered at an early stage
- the client may hold strong views on the colour of rock that can be used, which may restrict the designer's choice of rock
- provision of access for construction and maintenance plant and emergency vehicles are also important considerations in the design layout.

6.3.2.2 **Plan layout for different structure types**

This section discusses the relevant parameters and processes to be considered in the development of plan layout for each type of structure. The exact plan layout of a structure will be the subject of beach process studies and possibly computational and physical modelling. For complex sites, physical models may be required so that structures can be aligned and positioned correctly.

The CIRIA *Beach management manual* (Simm *et al*, 1996) gives in-depth guidance on beach behaviour and beach design. This manual therefore does not cover this subject in detail, concentrating instead on the design of the structures themselves. Aspects of beach behaviour that should be considered in design are highlighted here, concentrating on the interaction between beach control structures and sand and gravel beaches. The reader is referred to the *Beach management manual* for a full appreciation of the sediment issues.

The geomorphology of the area, layout of existing structures, position and interaction with sandbars, spits and other features are important considerations (see Section 4.1.2).

Modelling tools for design are discussed in general terms in Section 5.3.1 and it is recommended that the designer makes themselves aware of the different forms of modelling discussed in Section 5.3.1.

In some areas of the world, seismic activity and the need for stability in earthquakes is also a consideration. Refer to Sections 4.4 and 5.4.3.5 for further guidance.

There may be environmental constraints such as those discussed in Sections 2.5 and 6.3.2.1 above and these should be considered when determining the alignment and form of structures.

Scour protection and revetments

Rock structures are often used to protect existing seawalls or form part of rehabilitation works to damaged structures. Reflected waves from vertical seawalls can cause localised scour at the toe. Sloping walls can also cause reflections and experience scour, although to a lesser extent. The level of wave reflection from a wall is expressed in terms of the reflection coefficient, C_r . Guidance on the estimation of reflection coefficients is given in Section 5.1.1.5.

Scour protection for coastal structures will generally follow the alignment of the wall or structure to be protected. It is often associated with a gravel or shingle nourishment scheme. Rock scour protection for port structures is discussed in Section 6.2. Prediction of scour depth is discussed in Section 5.2.2.9. Figure 6.43 shows a concrete wall and stepped revetment protected by an anti-scour apron consisting of armourstone.

Revetments may also be used to provide protection against scour at structures, to reduce overtopping and to protect existing structures as well as to provide erosion control to natural coastlines. In these cases, the alignment of the revetment should ideally follow the average alignment of the beach contours or of the existing seawall that the revetment is strengthening or replacing, to minimise the impact of the structure on the beach orientation. Where the new structure is a replacement for a previously collapsed or failed structure it will be necessary to check that the wall alignment was not a contributing factor to the collapse. Figure 6.49 shows a partially constructed rock revetment to protect a seawall. Where a revetment is required to protect an embankment for reclamation then the reclamation area required will dictate the plan layout.



Figure 6.49 Rock revetment to protect a concrete seawall (courtesy Halcrow)

Where the plan layout of a seawall includes convex angles or significant concave curvatures with respect to incoming wave crests, focusing of reflected wave energy may occur in a limited area with potentially detrimental effects on beach processes. Protecting the seawall with a sloping rock revetment will tend to mitigate the most severe effects of concave and convex walls because of its reduced reflectivity and increased energy-absorption capabilities.

Groynes

The groyne concept is based on allowing the coastline between two groynes to reorientate towards the predominant waves, thereby reducing longshore sediment transport. The exact length, orientation and spacing of groynes depends on factors that include the seaward

extent of beach retention required and the grain size, and hence slope, of the beach material to be retained.

There are no simple and absolute rules for groyne length and spacing, as these critically depend on local conditions – beach material, water depth, wave climate, availability of beach sediment, longshore and onshore/offshore transport regimes etc. A study of morphological conditions and processes should be undertaken by specialists to inform the execution of detailed design. Modelling, both mathematical and physical, can play an important role in designing the correct locations of structures to optimise the design layout. Modelling methods are discussed in Section 5.3.

An important consideration when assessing the layout can be the study of any existing structures along the frontage and their relative success, or otherwise, in maintaining beach levels. Figure 6.44 in Section 6.3.1.3 shows a typical groyne.

The groyne layout will relate primarily to the beach type in question and the wave climate. The four principal beach types that are usually encountered and for which groynes might be considered are:

- gravel (sometimes termed *shingle*) beach
- gravel upper beach/sand lower beach
- gravel/sand mixed beach
- sand beach.

Special considerations are required when dealing with the last groyne in a system or with an isolated groyne on an otherwise ungroyned beach. Such terminal groynes may fulfil two functions:

- preserving the natural or nourished beach on the updrift side
- arresting the longshore drift to prevent siltation in an inlet to a tidal estuary, creek or harbour.

The **terminal groyne** might deliberately be made longer and higher than other groynes in order to create a reservoir of drift material, which can be mechanically transported to nourish depleted beaches. Figure 6.50 below shows how a large groyne (in this case a harbour arm) may be used to trap sediment and provide a borrow pit for recycling.



Figure 6.50 Large isolated groyne (harbour arm) trapping sediment (courtesy HR Wallingford)

In other locations it may be more important to reduce the immediate impact of downdrift erosion resulting from retention of littoral material in the groyne field, which would otherwise reach the downdrift beaches. In this situation the groynes should be made progressively shorter at the downdrift termination and **boot heads** should be provided, to form L-shaped groynes (see Section 6.3.4.4) pointing in the downdrift direction, to encourage diffraction and hence accretion in their lee. If the groyne bays are nourished artificially at the outset, the potential for downdrift erosion will be reduced initially and monitoring is recommended to study the long-term trend in potential drift.

It is very important to take into account the offshore losses; again, modelling can help the designer assess possible losses, especially during storm events.

Detached breakwater

Detached breakwaters have been used with most success on coastlines where the tidal range is negligible or small. They also offer considerable benefits, compared with groynes, when applied to wide foreshores of fine sand where the dominant sediment transport mechanism is onshore–offshore.

There are two components that contribute to sediment transport:

- transport as a result of waves breaking obliquely to the shoreline
- transport by currents caused by wave height gradients.

In the case of a detached breakwater, the wave height gradient creates a current into the lee of the structure, irrespective of the incident wave direction. When combined with reduced wave heights, this current results in deposition of material behind the breakwater.

In the absence of other influences, beach material will be transported into the area in the lee of the structure to form a **tombolo** or **salient**, as shown in Figures 6.45 and 6.51. Depending on the dimensions of the structure and its distance offshore relative to the wavelength of the incident waves (and the gap between adjacent structures if there is more than one), a tombolo may or may not attach itself to the structure.

The decision to allow the formation of a tombolo can be governed by whether:

- longshore sediment transport is required to prevent downdrift erosion – if not, then tombolos can be formed
- if a large amenity beach is required behind the breakwaters – if it is, then tombolos can be formed
- protection is needed to the shoreline – if it is, then tombolos can be formed.

Fleming and Hamer (2001) discuss the successful implementation of detached breakwaters along an eroding shoreline and consider the issues in the bullet-points above. The paper compares traditional design guidance with actual performance of the scheme in service. Key conclusions are as follows:

- if it is not desirable for the detached breakwater system to have a major impact on longshore sediment transport, then it should be located inshore of any nearshore features that may be primary sediment pathways
- tombolos will be more disruptive than salients to the longshore movement of sediment, but will offer more protection during severe storms, and will offer greater amenity area
- designs should be developed using detailed numerical and physical modelling; available guidance is generally only adequate for outline design and feasibility studies.

If the breakwater is positioned such that tombolos should be allowed to form, the public safety aspects as mentioned in Section 6.3.2.1 should be considered as the public will have full access to the structure.

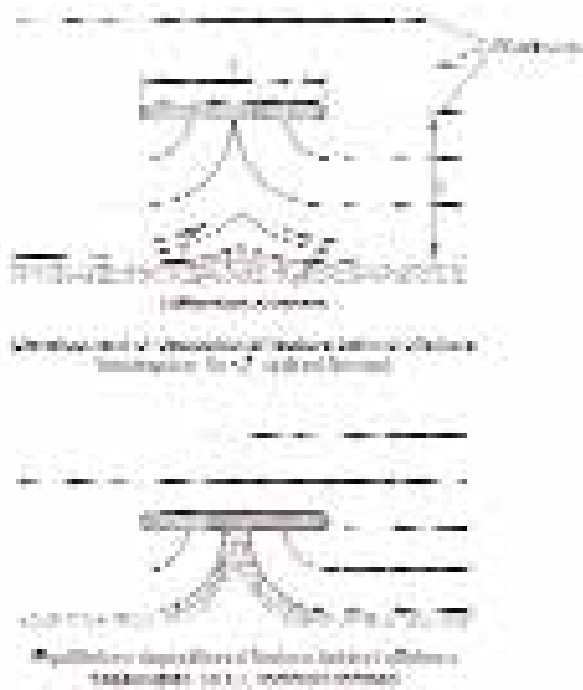

Figure 6.51
Detached breakwaters, development of tombolo and salients

An offshore or detached breakwater should be located approximately at the beginning of the breaker zone, which will allow it to influence the inner half of the active littoral zone. Typically, it should be at least three wavelengths from the coastline, based on a wavelength calculated at a point about one wavelength seaward of the breaker line. Breakwater length and spacing are a function of the required beach form. Tombolo formation may be attractive if a pocket beach structure is required and, in this situation, offshore breakwaters can be used in conjunction with sills. In other situations, less modification of the beach profile and interruption of longshore transport may be appropriate, and here typically the length may be set as being roughly equal to the distance offshore.

The spacing of the breakwaters is a function of the required reduction in inshore wave energy to protect the foreshore or prevent material loss. This reduction in energy is affected not only by the spacing (or opening size), but also by the crest elevation of the breakwaters. For example, breakwaters with a high crest will considerably limit the wave action on the area behind, which may encourage tombolos to form because of the reduction in wave energy, assuming longshore drift is low. The reader is referred to the *Beach management manual* (Simm *et al.*, 1996) for guidance on layout design for detached breakwaters used for beach control.

The alignment of the breakwater(s) should not necessarily be parallel to the local coastline, particularly if a single dominant wave direction, or limited spread of wave directions, exists. In the latter case it may sometimes be appropriate to set the line of the breakwater(s) parallel to the wave crests, if practical (eg construction and cost) considerations allow.

Any shore-parallel current that can pass between the breakwater and the beach can negate the wave-induced current effect and flush the material from behind the structure. This can be reduced or eliminated by making a connection between the offshore breakwater and the beach either by a causeway or a submerged reef-type structure. The former can often be built as part of the temporary works to facilitate construction, so that the additional costs are relatively small. This type of structure development leads to the consideration of fishtail, L-shaped or T-shaped groynes as an alternative.

Fishtail groynes

The concept of the fishtail groyne is to combine the beneficial effects of the groyne, offshore breakwater and tombolo and reduce the undesirable influences of the separate structures. The fishtail groyne, as shown in Figure 6.52, is a particular development of the artificial headland concept (Fleming, 1990). The fundamental difference between a groyne and an artificial headland is that the latter is a more massive structure designed to eliminate problems of downdrift erosion and promote the formation of beaches. While these structures may take different forms, their geometry is such that, as with the offshore breakwater, wave diffraction is used to assist in holding the beach in the lee of the structure.



Figure 6.52 Fishtail groyne, Llanelli, UK (courtesy DEFRA/Halcrow)

The basic plan shape of a fishtail groyne is shown in Figure 6.53. The breakwater arms OA and OB act to dissipate wave energy, while the arm AOC intercepts longshore drift. Thus, the updrift beach is formed by normal accretion processes associated with a groyne, while the downdrift beach is formed by those associated with an offshore breakwater. A precautionary note is that often the sediment collecting in the lee will be fine material and may lead to a soft beach in which members of the public may become trapped.

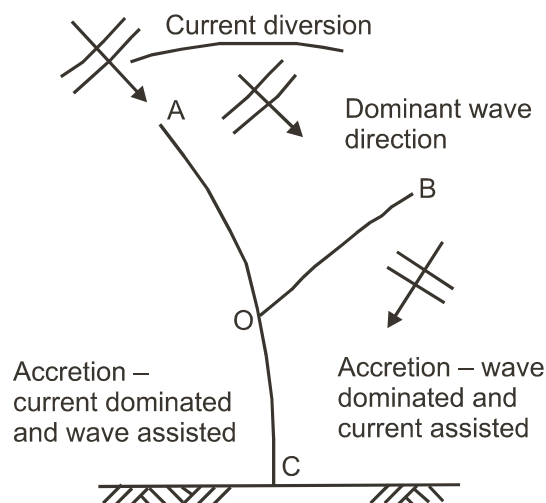

Figure 6.53
Orientation of arms in fishtail groyne

The arm AC, which acts to intercept and divert offshore, alongshore and tidal currents to minimise beach erosion, is curved in plan so that the axial alignment at A is normal to the streamline of the diverted alongshore and tidal currents. The axial alignment of the root-end (at C) is generally normal to the shoreline (see Figure 6.53). The curvature of COA is designed to minimise wave reflection effects on the concave side of the breakwater and consequent scouring. With its gently sloping sides and porous structure, the arm OA also encourages storm waves to diffract on to the structure and to pump sand into the root-end corner between COA and the shoreline. The arm OB is orientated approximately parallel to the most severe storm wave crests. In plan, it is located sufficiently inshore from A to allow waves to transform out of the current field. The length OB is partly dependent on the length of OC, but mainly dependent upon achieving the desired wave diffraction effects.

The overall groyne dimensions are thus interdependent and depend on wave height, direction and period, tidal range, beach morphology and the extent of required influence. The distance of A offshore depends on the length of coast the groyne is intended to influence, but should be greater than three inshore wavelengths as well as less than half of the width of the active littoral zone.

Wide, gently sloping roundheads are provided at A and B and have two functions.

- 1 To improve the efficiency of the structure in diffracting waves, thus reducing their energy and assisting in natural beach accretion
- 2 To provide a transition between sea bed and breakwater arm, reducing the tendency for wave reflection and helping to prevent scouring of the sea bed by tidal currents.

The fishtail groyne can be expected to influence the beach in a number of ways. There is usually a small steepening of the beach gradient due to current reductions caused by the breakwater. The beach may form a crenulate bay if the wave conditions are predominantly from an oblique wave direction. However, more often multi-directional conditions exist and more complex geometries will evolve. Where there is a high tidal range and a varied wave climate the beach will be constantly changing in plan level and gradient.

Roundhead design is similar to that for breakwaters and is covered in Section 5.2.2.13 and Section 6.1.4.1.

L- and T-shaped breakwaters

L- and T-shaped breakwaters have been widely adopted in areas of small tidal range, such as the Mediterranean, to enclose sandy pocket beaches. The layout design of these structures is comprehensively described in a set of design equations by Berenguer and Enriquez (1989).

The only difference from a pocket beach created by offshore breakwaters is that the land link is provided in advance, thereby reducing the initial quantity of sand nourishment required to create the beach.

Sill or submerged breakwater

Sometimes used in conjunction with L- and T-shaped breakwaters, sills can be adopted in areas of small tidal range to retain a beach of relatively mild slope known as a perched beach. Dean (1987 and 1988) provides a beach design approach for rock sills that should be combined as appropriate with the design equations by Berenguer and Enriquez (1989), also given in Simm *et al* (1996). Armour stability and side slopes will be as described for breakwaters, but the stability will be strongly influenced by crest elevation, which in turn is established by the beach level to be retained. Design guidance is given in Section 5.2.2.5 (see also Section 6.3.4.4).

6.3.3 Geometry of cross-sections

6.3.3.1 General considerations

Having selected a particular coastal defence concept and layout for evaluation/detailed design, the next step is to determine the cross-section form of the structure. This may be more or less constant along its length or may vary in dimensions and even in materials.

Like the concept and layout, the cross-section will be determined by various functional requirements, physical and planning policy boundary conditions, amenity and environmental considerations (see Section 2.5), materials availability (see Chapter 3), construction issues (see Chapter 9) and maintenance considerations (see Chapter 10). The designer should familiarise themselves with Chapters 3, 9 and 10 before selecting a preferred concept, as an understanding of the considerations discussed in these chapters is essential for the successful implementation of a particular structure or project.

If these considerations still allow for alternative designs then a final selection can be made on the basis of cost, taking into account the resultant benefits. There may be scope to deviate from standard design guidance, for example by accepting a higher maintenance requirement over the structure life, in return for using smaller armourstone sizes that are locally available. Such design decisions may only be appropriate if failure of the structure will not be brittle or catastrophic and where the owner is aware of the design decisions being made.

This section discusses some of the key factors that should be considered in cross-section design. It also describes the design, selection and sizing of the armour and underlayers that are of general application to all coastal structures. Structure details, including crests, toes and transitions for each of the coastal defence concepts covered in this chapter are then presented in Section 6.3.4. Where appropriate there is cross-reference to the design guidance provided for breakwaters in Section 6.1, as much of this is relevant for shoreline structures.

Overall hydraulic and geotechnical design of the structure should be carried out using the design tools presented in Chapter 5, taking account of the potential failure modes (see Section 2.3.1). Wherever possible, detailed designs should be checked in a hydraulic physical model (see Section 5.3.2). For dynamically stable structures this is often considered essential. Alternatively, uncertainties in the boundary conditions/design formulae may be translated into increased safety factors (in the case of small groynes, for example). For structures of significant size or importance, model tests will be cost-effective and lead to optimisation of the design.

Developing the cross-section design for shore protection structures depends on the following factors and choices:

- whether the armour is to be statically or dynamically stable
- if the armour is to be statically stable, the factor of safety required
- the required durability or lifetime of the armour
- the availability of different materials and materials systems
- the potential failure modes, given site-specific conditions.

Dynamically stable armour layers may be used if stone of adequate durability is available and if access and supply of materials is feasible for any maintenance requirement. The most likely situation for adoption of a dynamically stable structure for shoreline protection works is in offshore breakwaters, where a berm or reef breakwater concept may be appropriate (see Section 5.2.2.6 for discussion of the structural responses of these types of breakwater).

If statically stable armour layers are adopted, then the choice should be made between armourstone and the alternative stability improvement systems such as grouted revetments, concrete units or gabions described in Sections 3.12, 3.14 and 3.15.

The designer should take account of the potential failure modes of these alternative revetment systems, which are summarised by Pilarczyk (1990). Other matters to consider in selecting these alternatives to rock are environmental suitability, cost, and construction and maintenance aspects. This section considers the rock-based options only. If alternative materials are to be used then reference should be made to Sections 3.13, 3.16, 5.2.2.7 and Chapter 9 of this manual and to other literature. The use of concrete armour units for breakwater construction is discussed in Section 6.1, and design guidance is given in Section 5.2.2.3.

An understanding of failure modes is required to ensure that the design is developed to prevent or minimise the risk of failure. Key failure modes are summarised in Section 2.3.1 and in Section 6.1.3.4 for breakwaters. Where failure of rock structures does occur it is almost always due to one of the following reasons.

- 1 Undersizing of armour elements – see Sections 5.2.2, 5.2.3 and 5.2.4.
- 2 Underestimation of the wave climate – see Section 4.2.4.
- 3 Unsuitable detailing of the toe, transition elements and crest – see Section 6.3.4.
- 4 Lack of understanding of implications of overtopping of the structure – see Sections 5.1.1.3, 5.2.2.12, 6.1.4.1 and 6.3.3.3.
- 5 Unsuitable construction technique and placing – see Section 9.8.
- 6 Scour at the toe – perhaps the most common cause of failure – see Section 5.2.2.9.
- 7 Lack of understanding of geotechnical phenomena and features, in particular, shallow and deep slip circles (the latter combined with liquefaction) – see Sections 6.1.3 and 5.4.3.

Considerations that affect the cross-section of a structure are discussed in the following sections.

6.3.3.2 Physical boundary conditions

Sections 4.2 and 4.4 the definition of hydraulic and geotechnical physical boundary conditions in terms of winds and waves, water depths, tides and currents, coastal sediment processes, soil conditions and seismic activity. The definition and importance of exposure of the site should be carefully noted in cross-section design. Because coastal and shoreline protection structures are generally constructed in shallow water, they will at some time during the tidal cycle be located in the surf zone and subject to breaking waves. This also means that they are often located in the area of maximum sediment activity. Tidal range and timing of lowest tides may be a crucial factor in planning for construction (see Chapter 9) and maintenance (see Chapter 10).

The form of the cross-section may also be influenced by any existing structures along the shoreline. This is particularly true when carrying out rehabilitation of existing seawalls using rock. It is often cost-effective not only to protect the old structure but also to incorporate it into the overall concept.

6.3.3.3 Overtopping

For the majority of coastal structures, quantification of overtopping – ie the discharge of water over the crest – dictates the crest elevation required. It is common practice nowadays to design for this parameter rather than wave run-up, which does not quantify discharge over a structure.

Overtopping is dependent upon the crest level relative to SWL, the sea-side slope (angle and roughness), the crest configuration (see Sections 5.1.1.3 and 6.1), the berm width (if any) and the wave conditions. There is an inter-relation of these parameters with other design requirements and constraints such as maximum crest level or armourstone size. Methods to determine overtopping performance of a coastal rock structure are presented in Section 5.1.1.3.

Usual practice is to design structures to defend at least against those conditions that would damage the structure itself. Depending upon the nature of the land use or development behind, it may be necessary to provide higher standards for safety reasons or to prevent damage to property. It is also worth noting that tolerable discharges, although appearing small, can result in considerable flooding, and the depth/duration of flooding could be the controlling factor. Therefore it is important to establish precisely the design criteria. Figure 6.54 shows overtopping of a seawall.



Figure 6.54 Overtopping of seawall. Note pedestrians and proximity of small buildings (courtesy Halcrow)

An important consideration in many countries is that buildings or infrastructure lie behind the defence that will not withstand significant wave overtopping. Each location should therefore be assessed with regard to the infrastructure's capability to withstand any wave loading and also the ability to drain away water that overtops the defence. If the drainage infrastructure is not capable of collecting overtopping water and removing it quickly, then flooding will occur. Figure 6.55 below shows such a location in the Caribbean where overtopping of the revetment could cause damage to nearby properties.

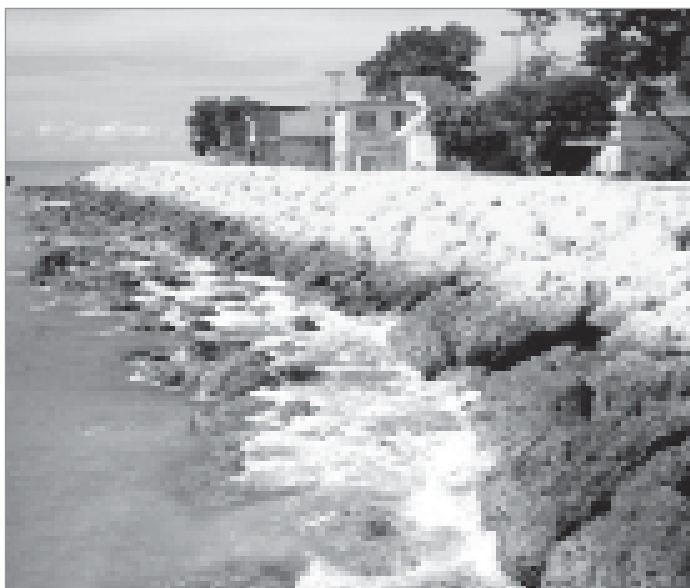

Figure 6.55 Typical location where overtopping may cause damage to local infrastructure (courtesy Halcrow)

Both calculated and stated tolerable discharges are often quoted as mean discharges (litres/s per m run or m³/s per m run), which can appear to be very small values. However, the actual discharge occurs randomly and may be in a small number of larger wave events. Maximum tolerable discharges per wave are also quoted, particularly with regard to safety on the crest of a structure.

In the case of structural damage, often a single large wave overtopping event may be more critical than the mean overtopping discharge over the duration of a storm event.

Methods for calculating overtopping are described in Section 5.1.1.3. Recently updated guidance on critical overtopping discharges and critical peak volumes associated with individual waves is presented in Table 5.4.

Safety

Account should be taken of safety under overtopping conditions. In particular it is necessary to assess likely damage to other structures behind the line of the coastal defence, such as buildings, and safety of the public and vehicles on the crest of a structure or a promenade or roadway immediately landward of the structure. Meeting these criteria can result in extremely large structures, however, so it is usual to design for these conditions only in exceptional circumstances (eg where a highway lies directly behind the seawall) or on a downtime principle, allowing the condition to be exceeded only a certain number of times per year. In most cases it will usually be much cheaper to commit to providing a warning or restricting access than to build the larger defence structure. Table 5.4 gives guidance on acceptable discharges for overtopping relating to safety and identifies rates where risk to the public will occur.

Structural damage

Structures are normally designed for the non-exceedance of a critical overtopping discharge for a selected extreme condition, to avoid structural damage. The critical discharge values vary depending upon the form and type of structure and the degree of protection provided to that structure. The definition of protected and unprotected is also worth noting: *protected* refers to a concrete revetment/pavement and *unprotected* refers to compacted soil, grass or clay. In some situations structural damage is more likely to occur than others, eg a brick building will withstand wave impact better than timber construction.

Table 5.4 gives guidance on acceptable discharges for overtopping relating to structural damage.

For shoreline structures, these critical discharges are often only applicable to storm waves that are a few metres high and continue for a few hours only, for example over the peak of a tide. Goda (2000), however, states that the critical discharge should be lowered for situations where structures face the open ocean and may be exposed to attack from large waves, or for structures subject to many hours of storm wave action. This should be considered when designing for such circumstances.

Flooding

While the design discharge overtopping rate may not present a structural stability problem, it may still produce extreme flooding. For example, a design for a rock revetment structure may be structurally sound, but, if overtopped, the area behind the revetment may be inundated with discharges far in excess of drainage capacity.

Tolerable discharges can be calculated based on the known drainage capacity or determination of the size of the flood area and limiting acceptable depth, converting this into a **total** acceptable volume per linear metre of defence. In the latter case, actual discharge would then

also be calculated as a total volume, rather than a mean rate, calculating incremental volumes with water level variation across the peak of the tide.

In certain countries there may be legislation governing a limit on acceptable discharges. These should be investigated and considered when planning a scheme from the outset as the legislation may set the crest levels for any defence.

6.3.3.4 **Slope design**

Most of the structures discussed in this section and designed using the methods described in Section 5.2.2 are known as statically stable structures. Although they are not rigid and do have potential to adjust their profile or settle into place, their design is based upon no or only minor damage under the design condition with the mass of individual units large enough to withstand the anticipated wave forces. In contrast, for dynamically stable structures development of the profile while in service is acceptable and is incorporated into the design. Typical examples are rip-rap revetment slopes and berm breakwaters.

Dynamically stable structures, in particular berm breakwaters, are discussed in Sections 6.1.6 and 5.2.2.6. The principle of dynamically stable design is that the materials can move until an equilibrium profile is achieved, in much the same way as a beach responds to wave activity, although to a far lesser extent. A benefit of this approach is that a much wider grading of material (and potentially smaller stone sizes) can be used. There is less need for individual placement of units, making this a favourable choice for deep-water structures; however, the greater mobility will normally require use of a much larger quantity of material. The key design considerations are determination of the expected extent of mobility of the material and ensuring that a minimum thickness of protection is obtained at all points such that the underlying materials are not exposed.

To design rock-armoured slopes for shore protection the following factors should be taken into account, given the physical boundary conditions evaluated in accordance with Section 4.2.

- 1 Required slope for armour layer hydraulic stability – see Section 5.2.2.2.
- 2 Required slope, crest level and width of berm(s) for limiting run-up/overlapping to acceptable values – see Sections 5.1.1.2 and 5.1.1.3, with acceptable overtopping rates given in Table 5.4.
- 3 Required slope of structure such that reflections, and therefore potential scour, is limited – see Sections 5.1.1.5 and 5.2.2.9.
- 4 Required slope, crest level and width of berm(s) to ensure adequate stability against geotechnical slip failure – see Section 4.3.2 and Section 5.4.3.
- 5 Cost considerations for overall volumes of material (which increase with gentler side slopes and higher crest levels) and armourstone size (which reduces as side slope becomes gentler, although quantities will increase as a result).

The designer should also remember that with steeper slopes, the armour unit size required for stability increases, which may have implications for construction and maintenance methods and plant requirements and therefore cost.

6.3.3.5 **Armour layer**

Formulae for calculation of armour stability are presented in Section 5.2. The equations will depend on the type of structure being designed. The relevant sections are as follows:

- rock armour layers on non-overtopped structures – Section 5.2.2.2
- concrete armour layers – Section 5.2.2.3

- low-crested (and submerged) structures – Section 5.2.2.4
- reshaping structures and berm breakwaters – Section 5.2.2.6
- stepped and composite slopes – Section 5.2.2.8.

The appropriate equation(s) should be selected taking into account the range of validity and any other factors, for example the water depth conditions and type of waves at the structure (plunging or surging), that are relevant for the calculation methods given in Section 5.2.2.2.

Unless otherwise stated, the occurrence of wave breaking/shallow-water effects should be established and the local wave height at the structure toe should be used in the design formulae. Single-layered rock structures are not generally advocated. This is for two reasons. First, a single layer will perform in a different way from a double layer, with reduced interlock, greater internal reflectivity, less wave energy dissipation and hence reduced stability. This makes sizing of armourstone difficult, as the formulae are derived from model testing of double armour layers. Second, the filtering characteristics are also lost, with potentially large voids between individual stones. There may be scope to form a single layer with a graduated reduction in size for secondary layers (ie slightly smaller stone), although such proposals require physical model testing to develop an acceptable design. The usual practice is to provide a double layer of armourstone, with a thickness equivalent to $2 k_t D_{n50}$; see Section 6.3.3.7.

6.3.3.6 Underlayers and filters

Traditionally, breakwater and revetment design has been based upon underlayers or filter layers being sized by mass, relative to the mass of the armour layer. In general these are governed by filter rules to prevent migration of underlayer material through the armour layer. While having some value in terms of armour stability, stone size characteristics can be more important than mass in many applications. Common practice now is to use filter design rules based upon stone sizes. Mass still plays a part in determining primary underlayers, particularly when concrete armour units are used. Filter rules are presented in Section 5.4.3.6. Some discussion on underlayers is also given in Section 5.2.2.10.

Filter layers may be required for a number of reasons: to prevent washing out of finer material, provide drainage, protect sub-layers from erosion due to flows, and to regulate an uneven formation layer.

Underlayers, cores and filters are usually made of granular material, generally quarried rock. River gravel may occasionally be used as a filter, although attention should be given to the potentially lower internal stability of such material because it is more rounded. Geotechnical stability can be an issue in some situations. A description of internal stability issues and their importance and consideration during design is provided in Sections 4.4 and 5.4. In many cases, application of the methods as described in Section 5.4 will be adequate and a detailed analysis of internal failure mechanisms will not be required. However, a sound appreciation of the potential geotechnical problems and design requirements is recommended to enable that decision to be taken.

A relatively large underlayer produces an irregular surface, providing greater interlocking between armour layer and underlayer. It also produces a more permeable structure, thereby improving wave dissipation and armour layer stability.

The underlayer in a revetment may also function as a filter layer, placed on a fine material such as clay or sand, either with or without an intervening geotextile filter. It is important that small particles beneath the filter are not washed out through this layer and that the filter/underlayer stone itself is also not lost through the armour layer. For these reasons, internal layers need to be appropriately sized to suit the dimensional characteristics of the

materials both above and below. To achieve this, a multi-layer system may be developed, or it may be preferable to incorporate a geotextile, particularly for constructing in the dry.

If the revetment is to be constructed in the wet then the use of geotextile needs special care as the material will float during installation, which will make construction difficult. The geotextile may be ballasted with stones or steel rods. Composite mattresses may also be used. Geotextiles are discussed further in Sections 3.16, 5.4.3.6 and 9.7.1.

An alternative approach may involve incorporating a very widely graded layer of sufficient thickness, which will be partially sacrificial (ie with losses through the armour). However, this will result in some settlement of the armour and may therefore be most appropriate only with those rip-rap slopes where some deformation is acceptable. To evaluate such widely graded filters, an approach is to check both the upper and lower limit curves for the grading. The designer should refer to Section 3.4.3 for guidance on gradings and how to specify them as part of the design.

The armourstone cover layer and underlayer should also appropriately match the underlying permeability/pore size of the material being protected (see filter rules discussed in Section 5.4.3.6), with appropriate permeability/pore size transitions using filter layers and geotextiles.

Geotextile filters

Geotextile filters can be used as an alternative to underlayers and can also provide benefits for toe design (see Section 6.3.4.1 for further discussion on toe details). Care should be taken when using geotextiles to ensure that they have sufficient strength to resist construction loads, as these may often be the most critical. The geotextile should be specified with sufficient puncture resistance to prevent damage. It is usually preferable to place a layer of smaller granular material on the geotextile to prevent damage during construction.

Geotextile filters are discussed in more detail in Section 3.16, including guidance on their specification. Further discussion on construction using geotextiles is given in Section 9.7.1. Key advantages and disadvantages for their use in coastal structures are summarised below.

Advantages:

- replacement of underlayers, saving in material, material transport and placement costs. In some cases transport of coarse armourstone can be almost impossible, eg in shallow tidal waters at the base of a cliff where barges cannot manoeuvre close enough to dump. This is not a problem in the case of large armourstone, which can be beached and manoeuvred into place by excavators
- minimises the amount of “lost” material at the toe where stones bury themselves into a soft subsoil
- its sheet-like qualities reduce the differential settlement, helping with long-term maintenance of alignment of a revetment or breakwater
- can be used to establish a *hung toe* on long shelving embankments where soft alluvial silts prevent the establishment of passive resistance to establish a base for construction of the rest of the revetment. Reinforcing geotextiles and grids can be made into bags or gabions and *hung* from an anchor trench higher up or at the top of an embankment.

Disadvantages:

- in turbid, turbulent water it may be impossible to place geotextiles flat on the required slope profile, in position and overlapped. Although some good installation techniques are available there are limits to placing geotextiles in unprotected wave environments or strong currents. Some of the techniques for laying are discussed in Section 9.7.1. Use of a frame to lay a geotextile underwater is illustrated in Figure 6.56

- poorly positioned geotextile that has not been properly covered can result in flaps of geotextile being exposed, causing a danger to shipping by fouling propellers. If it is impossible to mark the edge of the geotextile reasonably accurately to ensure coverage and proper overlapping then geotextiles should be avoided
- although geotextiles have a wide range of permeabilities they should not be used where the core material of an embankment is made up of coarse boulders or gravel. It is most important not to place a geotextile over a highly permeable core material under revetment armour. In wave attack and high currents the underlying water pressure will cause uplift on the geotextile, resulting in either the tearing of the geotextile (with consequent loss of core material) or displacement or even removal of the armour
- where frequent rock outcrops occur under water, placement of stone on top of the geotextile will inevitably damage the material, causing a hole to form and leading to loss of fines from adjoining soft areas. With care and proper anchoring in “dry” installation, geotextiles can be shaped to fit with adjacent outcrops.



Figure 6.56 Placement of a geotextile using a frame (courtesy HR Wallingford)

6.3.3.7 Layer thickness

In general, the thickness for any armourstone layer is a minimum of at least two stones (calculated as $2k_t D_{n50}$), where k_t is the layer thickness coefficient, which is a function of stone shape and type of packing. Filter or underlayers may require considerably greater thickness to be effective and practical. Layers of less than two stones can be destabilised by internal wave pressures and lack of interlock.

Typical layer thickness coefficients, k_t , and corresponding layer porosities, n_v , are presented in Section 3.5.1, based on field and laboratory tests of practically achievable layer thicknesses for different stone shapes, types of packing and thus porosities. Section 5.2.2.2 presents guidance on the influence of these factors on hydraulic stability of rock-armoured slopes of non-overtopped structures. Definition of a realistic layer thickness requires an understanding of methods of construction and types of packing (see Section 9.8.1). Construction of a trial panel is a practical approach to confirm what can be achieved on site; see Section 9.8.4. The rock source can have an influence on the packing density and layer thickness that can be

achieved; for example, certain rock sources produce stone that is considerably more cubic than others.

In some situations a double layer will not be applicable, such as where concrete armour units are used on the outer face in a single layer and where a dynamically stable structure is designed (see Section 6.1.6). Layer thicknesses for concrete armour units are discussed in Section 3.12.

For filters and underlayers, the minimum layer thickness is usually specified as a function of the median nominal armourstone size. As this becomes smaller, however, the thickness needs to be a practical minimum for placement and irregularities and tolerances.

For cores and layers of wide-graded material of multiple stone thicknesses, the layer coefficient becomes irrelevant. As a general rule of thumb, an armourstone layer thickness of 300–500 mm is a practical minimum.

For other materials, recommended minimum layer thicknesses depend upon the nature of material, likely deformation and placement conditions. Care is required when specifying very wide gradings ($D_{85}/D_{15} > 2.5$) for armour layers only two or three stones thick, as this may lead to stability and segregation problems within the structure. Gradings are covered further in Section 3.4.3.

6.3.4 Structural details

Sections 6.3.4.1–6.3.4.3 give guidance on the design of toe, crest and transition details that are generic to all structure types. Specific issues for each structure type are discussed in Section 6.3.4.4.

6.3.4.1 Toe design

Toe details should provide protection against scouring and undermining of a structure and support against sliding to the structure armour/face. The toe therefore needs to be designed to prevent the occurrence of these two possible failure modes.

Experience and engineering judgement play an important role in selecting appropriate toe details and applying the design rules presented, which are themselves largely based upon experience rather than systematic testing.

Armourstone is often the favoured material for toe protection because of its flexibility. However, other forms of toe protection are available such as various mattresses. Reference should be made to supplier's literature with regard to the use, applicability and dimensioning of these systems. Often manufacturers of concrete armour units and other forms of structure will provide an in-house design service. The designer should satisfy himself, if it is the intention to use such a service, that all relevant details on wave climate etc are provided to the manufacturer at an early stage.

The toe needs to extend down to a level such that it will not be undermined, or it should contain sufficient material and be flexible enough to drop down to a new level if bed levels change. This will involve selection of an appropriate geotextile, ie one that is both flexible and strong enough to allow for such deformation (see Section 3.16 and discussion on use of geotextiles in Section 6.3.3.6).

Toe design should therefore be based upon best predictions of lowest anticipated seabed/beach levels, the anticipated depth of scour, and calculation of material dimensions to provide the required stability under extreme conditions. In this respect it is important that all potential scenarios are considered. For example, a range of wave and water level

combinations should be investigated to assess scour depth and toe stability – the worst case conditions may occur at a low water level even though wave heights may be lower. Consideration should also be given to the full life of the structure, ie to take account of natural foreshore changes and potentially increased wave activity at the end of the service period. For most coastal structures, wave forces (downrush and breaking) present the critical conditions when determining stability of the toe. However, currents can become important, particularly in deeper water or more sheltered sites where wave activity is restricted.

In summary the important considerations in establishing the nature of toe protection required are:

- location of the structure (scour is most severe near the wave-break point)
- form of structure (wave forces produced as a result of reflectivity or downrush)
- nature of the bed (resistance to erosion and grain size)
- nature of structure, revetment, breakwater etc.

As a general rule, scour potential is greatest where the water depth at the toe is less than twice the height of the maximum unbroken wave.

Special attention should also be given to areas where scour may be intensified, such as changes in alignment, structure roundheads, channels and downdrift of groynes etc.

Design methods for scour and toe protection are presented in Section 5.2.2.9.

Depth and form of toe detail

The basic principle of flexible toe protection is to provide an extension of the armour face such that the foundation material is kept in place beneath the structure to the bottom of the maximum depth of scour. Caution should be exercised if a non-flexible toe protection is to be adopted as this will not accommodate any change in profile if scour is to occur, which may lead to brittle failure.

When placing stones in a situation where the toe is below low water the construction aspects covered in Section 9.7.1.2 should be considered. The use of geotextiles should be carefully considered prior to their inclusion in a design with respect to installation, also covered in Section 9.7.1.2. Consultation with experienced installers and manufacturers should help assess the feasibility and cost benefits of using them. Consideration should be given to whether suitable granular underlayers and filters can be used instead.

A range of toe details are presented in Figures 6.57 to 6.64 for the following ground conditions.

- 1 Rock foreshore.
- 2 Impermeable layer near foreshore level.
- 3 Sand/gravel foreshore.

Different construction scenarios are discussed below. The list of examples is not exhaustive and there may be situations where a combination of the examples shown may be applicable.

The toe details shown in Figures 6.57–6.64 indicate that a geotextile may be necessary where construction is to take place on a granular material, to prevent loss of bed material through the structure. The designer should check whether a geotextile is required to ensure interface stability criteria between adjacent granular layers are met (see Section 5.4.3.6). This applies to the transition between the bed material and the placed layers (core or underlayer) and also between adjacent layers within the structure, for example between the underlayer and the core.

1 Rock foreshore

1a Concrete piles inserted into bedrock and concrete toe beam laid on beach. Rock toe placed on bedrock up against toe beam, see Figure 6.57.

Advantages:

- no excavation in bedrock.

Disadvantages:

- extra plant required for installation of concrete piles into bedrock (eg piling rig)
- concrete toe beam may need maintenance if damage occurs during installation and life cycle of revetment
- work on toe beam difficult because of possible collapse of revetment when beam is removed
- potential scour at face of toe beam caused by reflected waves
- abrasion and corrosion of steel in piles should be considered in design of toe pile.

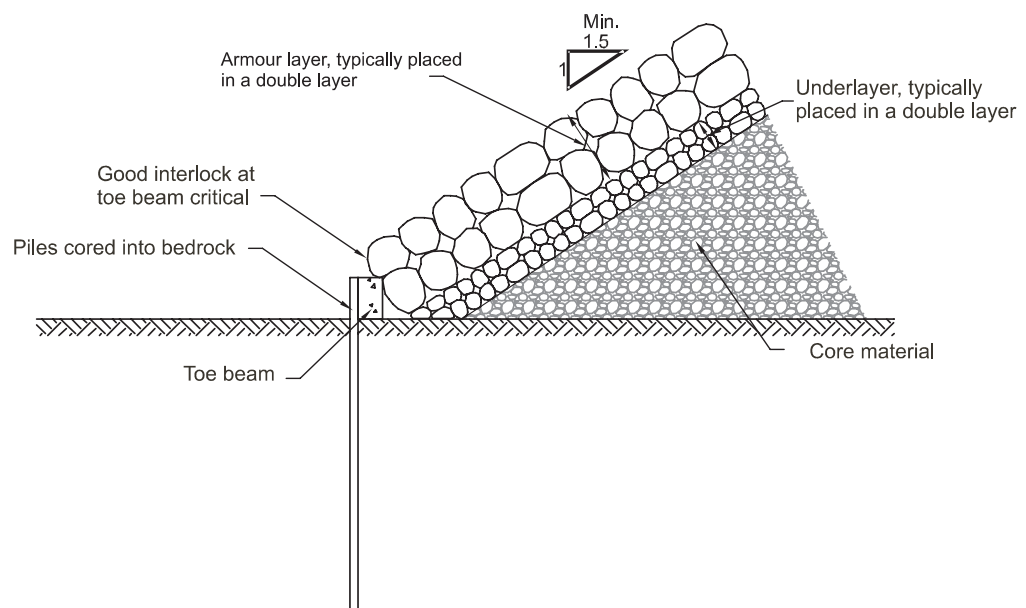

Figure 6.57 Toe detail 1a: rock foreshore – piled toe

1b Trench excavated into bedrock to a minimum depth of $0.5D_{n50}$, see Figure 6.58. This depth is to be considered as a minimum and the designer should consider the exposure of the particular site when determining the depth of trench. It is essential that good interlock of both layers of primary armour is achieved to prevent the upper layer rolling off of the secondary layer of armour in storm conditions.

Advantages:

- avoids the need to drive piles.

Disadvantages:

- excavation in bedrock required, which may require specialist rock breakers.

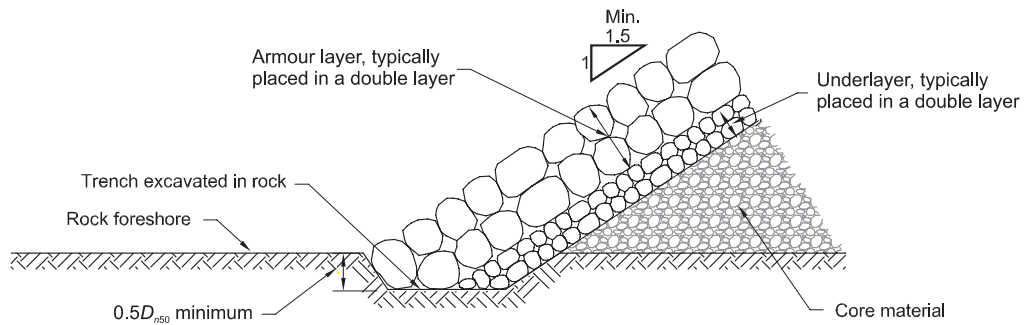

Figure 6.58 Toe detail 1b: rock foreshore – excavated trench

2 Impermeable layer near foreshore level

Near to the sand/gravel surface (< 3 m) of a beach there is often an impermeable layer of rock or clay. Care is required when considering toe details in such locations because the impermeable layer may cause the sand under the toe to become “fluid”. This will allow the toe to settle deeper than anticipated as pore water pressure acts on the sand. This can be countered in the following two ways.

2a Allow for regular top-up of the toe in maintenance regime, see Figure 6.59

If the impermeable layer is deeper than, say, 3 m the construction considerations make this option more practical, by minimising the depth of excavation required, for example. If the excavation extends below low water it will be full of water and the contractor may need to use dewatering techniques.

If this approach is adopted the designer needs to consider how the interim maintenance top-up operation is to be undertaken. Issues such as access, availability of plant, quantities, armourstone delivery to site all need to be addressed. Maintenance issues are discussed in detail in Section 10.5. If this option is not practical because of in-service restrictions on access etc, option 2b shown in Figure 6.60 is an alternative.

Advantages:

- armourstone quantities stay low compared with option 2b
- no large excavation required on the beach.

Disadvantages:

- possible settlement of structure because of pore pressures beneath toe.

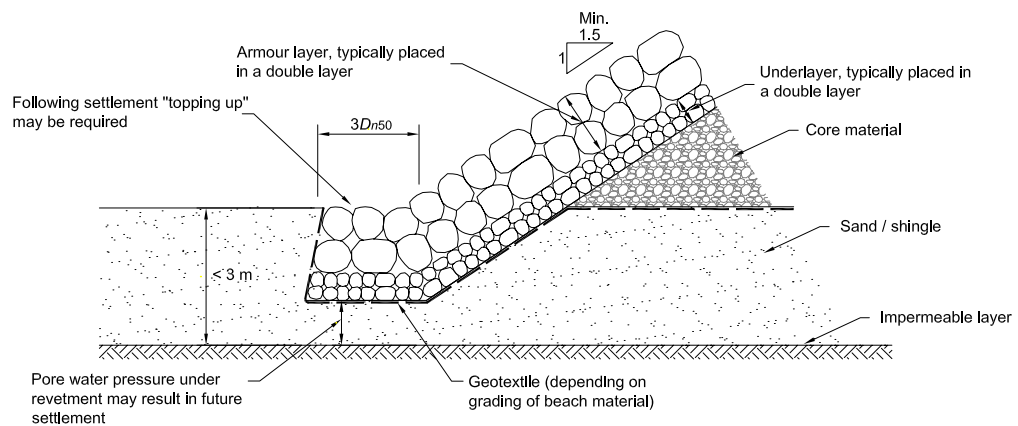

Figure 6.59 Toe detail 2a: impermeable layer near foreshore level – some interim maintenance needed

2b Excavate to the impermeable layer and place the toe on it, Figure 6.60

This option is normally only possible where the layer is no more than 3 m below the beach. The need for dewatering of excavations below low water may limit use of this approach. If there are limited possibilities to undertake the interim maintenance of option 2a shown on Figure 6.59 then this method will need to be adopted.

Advantages:

- no settlement of structure from undermining of the toe because of pore pressure.

Disadvantages:

- significant excavation in beach material on the foreshore, particularly as side slopes will not stand at a steep angle, requiring a large area of excavation
- dewatering may be needed because of water in the excavation
- the quantity of armourstone in the structure will increase due to lower formation level
- excavation will fill in partially between each tide and will require re-excavation.

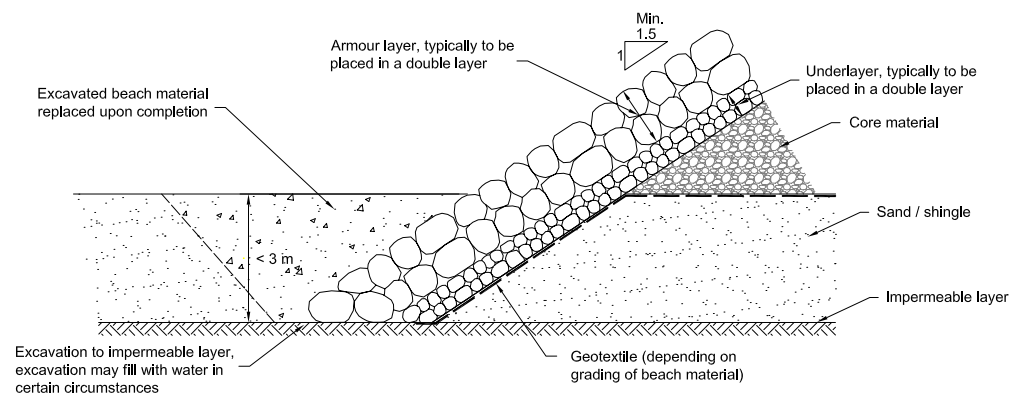

Figure 6.60 Toe detail 2b: impermeable layer near foreshore level – excavation to bedrock

3. Sand/gravel foreshore

3a Low scour potential

Armourstone toe placed directly into excavated trench with toe width equal to one armour stone placed directly on underlayer, see Figure 6.61. The depth of excavation should be at least the depth of anticipated scour. This form of toe is commonly used for sites where there is low wave energy or little or no scour predicted. The armourstone is used either with underlayers or a geotextile filter.

Advantages:

- simple construction, relatively easy to maintain.

Disadvantages:

- localised scour holes will occur around toe rocks
- should not be used in cases where significant scour is anticipated
- in intertidal zones re-excavation of beach may be required during construction.

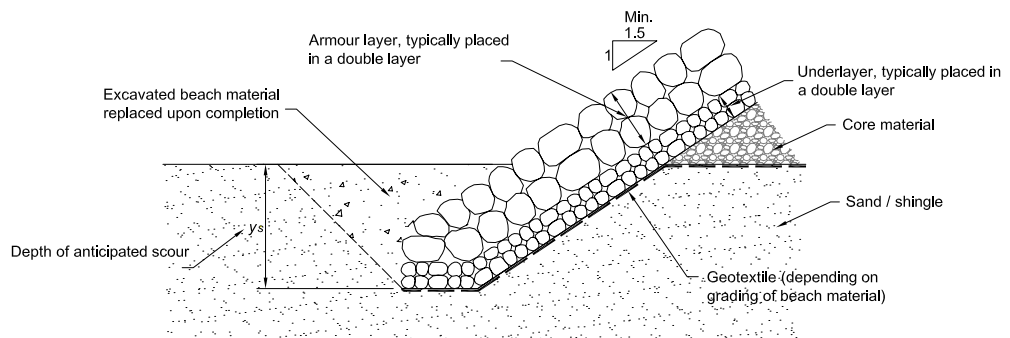

Figure 6.61 Toe detail 3a: sand or gravel foreshore with low scour potential

3b Moderate scour potential

Armourstone toe placed directly into excavated trench with toe width equal to $3D_{n50}$, see Figure 6.62. The depth of excavation should be at least the depth of anticipated scour. This form of toe is commonly used either with underlayers or a geotextile filter.

Advantages:

- simple construction, relatively easy to maintain.

Disadvantages:

- localised scour holes can occur around toe armour stones
- in intertidal zones re-excavation of beach may be required during construction.

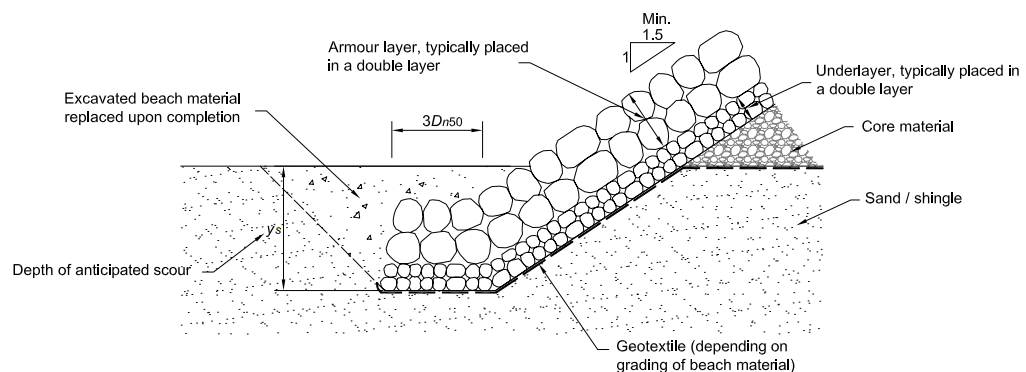

Figure 6.62 Toe detail 3b: sand or gravel foreshore with moderate scour potential

3c Severe scour potential – excavated trench

Armourstone toe placed directly into excavated trench with toe width equal to $2y_s$ (see Figure 6.63), such that scour will only affect the toe under severe conditions. Where a geotextile filter is used, an optional Dutch toe may be incorporated into the design, with the geotextile wrapped back around the toe stones. This form of toe is commonly used where the construction takes place in wet conditions, ie mid-tide level. Use of a geotextile may be eliminated for wet construction scenarios.

Advantages:

- simple construction, relatively easy to maintain
- allows for severe erosion.

Disadvantages:

- possible deep excavation with side slopes difficult to maintain, particularly where construction is in the wet
- localised scour holes will occur around toe stones.

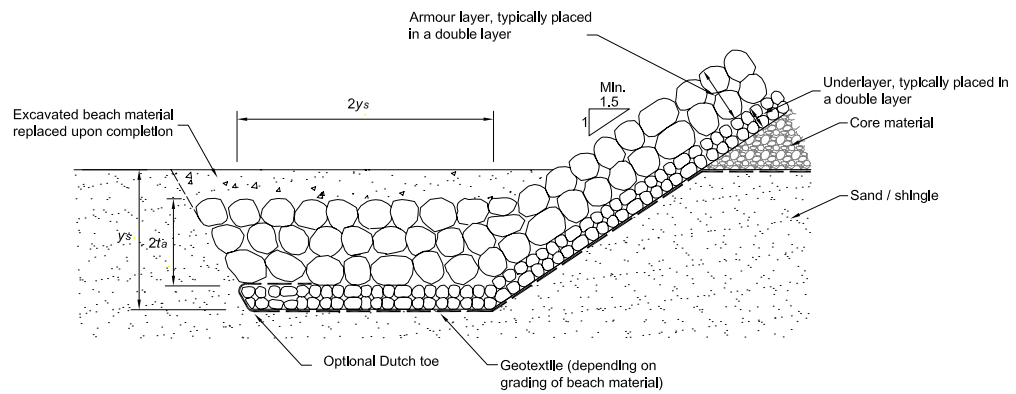

Figure 6.63 Toe detail 3c: severe scour potential – excavated trench

3d Severe scour potential – no excavation

The armourstone toe is placed directly on to beach with toe width equal to $3y_s$; see Figure 6.64. There is no excavation, but the toe contains sufficient material to create a falling apron, which lines the face of the scour hole that is created. Where a geotextile is used, a Dutch toe detail may be adopted, with the geotextile wrapped around the toe stone. This form of toe is commonly used with underlayers in conditions where construction is in the wet, although sometimes it is impractical to use a geotextile in these conditions.

Advantages:

- simple construction, relatively easy to maintain
- avoids the need for excavation.

Disadvantages:

- localised scour holes will occur around toe armour stones.

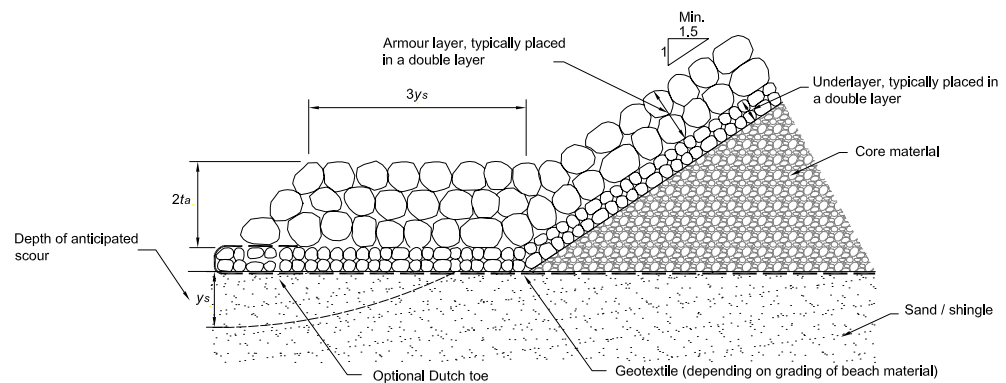

Figure 6.64 Toe detail 3d: severe scour potential – no excavation

To take into account potential scour effects the geotextile is sometimes wrapped around the toe rock before completion of the toe, called a *Dutch toe*, see Figure 6.65 and the toe details in Figures 6.63 and 6.64. The *Dutch toe* can be achieved by wrapping around a single row of primary armour stones as shown, or around bedding stone and then trapped by additional primary armour stones. Construction of this detail is significantly more difficult in the wet and is generally not practical under water.



Note: Wrapping the geotextile around heavy armourstone is only an appropriate method if the geotextile is of sufficient strength; see also Sections 6.3.3.6 and 3.16.

Figure 6.65 Construction of Dutch toe, geotextile being wrapped around toe stones (courtesy Halcrow)

Width of toe protection

In general, scour can be assumed to be greatest within one-quarter wavelength of the front of the armour slope. The width of the toe or extent of protective apron needed depends on the depth of erodible sea bed, as well as waves and current. It may be reasonable to assume that such protection need not usually extend further than one-quarter wavelength, although this can be a significant distance and probably in most cases is well in excess of actual requirements.

For revetments, a toe apron should extend to a width of at least three times the depth of scour, predicted from Section 5.2.2.9.

Guidance generally recommends any cover/armour layer to the toe to have a minimum thickness of at least $2k_l D_{n50}$ (ie two units thickness, where k_l (-) is the layer coefficient based on placing technique and stone shape). This should be seen as a minimum requirement; a greater thickness may be required to achieve this with any form of falling apron. Section 3.5.1 discusses layer thickness and voids within armour layers.

6.3.4.2

Crest design

A minimum practical width of crest protection of three primary armour stone widths, ie $3k_l D_{n50}$, is suggested. As a conservative rule of thumb, Pilarczyk (1990) also suggests that the crest and lee-side slope may be protected over a width equal to the projected extent of run-up (see Section 5.2.2.11). Crest and rear-side stability design methods, for rock structures that are only marginally overtopped, are discussed in Section 5.2.2.11. Sections 5.1.1.2 and 5.1.1.3 give guidance on formulae and design methodologies for calculating run-up and overtopping. Using three primary armour stones also makes the construction of the crest easier; if only one or two armour stones are used there may be problems with interlock and stability.

Section 6.1.4 discusses on dimensioning crests of rubble mound breakwaters, based on the construction plant requirements, which may also be applicable for shoreline structures. Construction issues for seawalls are discussed in Section 9.7.3. Section 9.7.2 on breakwater construction also provides some useful information. Chapter 10 discusses issues of maintenance access.

Crown walls

A crown wall may be used to provide an edge to prevent vehicles or pedestrians from gaining access to a coastal structure or to prevent overtopping to the area behind it. Guidance on overtopping is given in Section 5.1.1.3. Figures 5.13, 5.14, 6.68a and 6.69 illustrate typical cross-sections for revetments with crown walls subject to overtopping. The reader is also referred to Section 6.1.5, which discusses crown walls for rubble mound breakwaters.

Guidance for estimating wave loading on crown walls can also be found in Section 5.2.2.12. The designer should consider whether it is advisable to place a reinforced concrete structure on a site exposed to overtopping and, if so, should make suitable allowance in the design of the concrete in terms of maintenance. It may be possible to increase the height of the structure so as to reduce overtopping rather than to incorporate a concrete crown wall. Although it is often the client who decides whether this option is to be adopted or not, both the designer and the client should be aware that the use of reinforced concrete in the marine environment needs to be carefully controlled.

6.3.4.3**Joins and transitions**

However well-designed the cross-section may be, the overall rock structure is only as strong as its weakest section, so particular care is required when designing transitions. This is of particular relevance for revetments and seawalls. Transitions may be either along the length of the revetment or with existing or different structures or revetment types. Experience has shown that erosion or damage often starts at such joints and transitions, so it is recommended to locate them in sheltered areas if possible.

Different treatments may be required to protect different parts of the cross-section and may include the following: toe protection, lower slope protection in the area of heavy wave and current attack, upper slope protection (for example, a grass mat), and protection of any berm provided to reduce run-up or as a maintenance road. A variety of materials and construction methods may be used for these parts and hence careful attention should be paid to the joints between them.

Similarly, a new slope protection may need to be connected at one end to an existing construction built from a different material. Here again careful attention is needed, including avoiding sharp angles and curves.

In general, joints and transitions should be avoided as much as possible by treating cross-sections and entire coastal cell units in a unified manner. If they are inevitable, the discontinuities in behaviour that are introduced (eg in load-deformation characteristics, permeability etc) should be minimised and high-quality construction employed.

It is difficult to formulate more detailed principles and/or solutions for joint and transitions. The best way is to combine the lessons from practice with some physical understanding of the systems involved. As a general principle, the transition should be of a strength equal to or greater than the adjoining systems. Very often it needs to be reinforced by:

- increasing the thickness of the cover layer at the transition by one layer of armour
- putting the transition in an area of low energy (protected area)
- using concrete edge-strips or boards to prevent damage progressing along the structure.

Discontinuities

There are situations where a discontinuity exists within a rock structure. Weak points can exist within any structure, and the location and configuration of these should be considered carefully. Discontinuities could take the form of one of the following.

- 1 **A pipeline normally used for land drainage passes through the revetment.** Here it may be appropriate to increase the stability of the rock armour and underlayer locally around the pipe with concrete or asphalt grout and to use the stabilised area to provide an appropriate haunching to the pipe. The designer should be aware of the possibility that the revetment may settle and to the effect this could have on the pipe. It may be suitable to stop the pipe in the underlayer so that it does not penetrate the primary armour and create a potential weak spot in the defence. If this approach is adopted the designer should consider the effects of the flow within the core material and be satisfied that it will not wash out any of the material and thereby cause settlement. The size and flow out of the pipe are important considerations. A small-diameter pipe is likely to be easier to accommodate than a larger one.
- 2 **An access path for pedestrians or ramp for vehicles may be needed.** Figure 6.66 shows a site where a vehicle access ramp to the beach has been incorporated within a revetment. The primary armour protects the ramp, which is aligned such that it will not be hit by large waves. When positioning such structures, attention needs to be paid to wave direction and stability, and generally it is advisable to place ramps in protected areas. Smooth concrete ramps could lead to further run-up and overtopping if placed in areas subject to wave action.

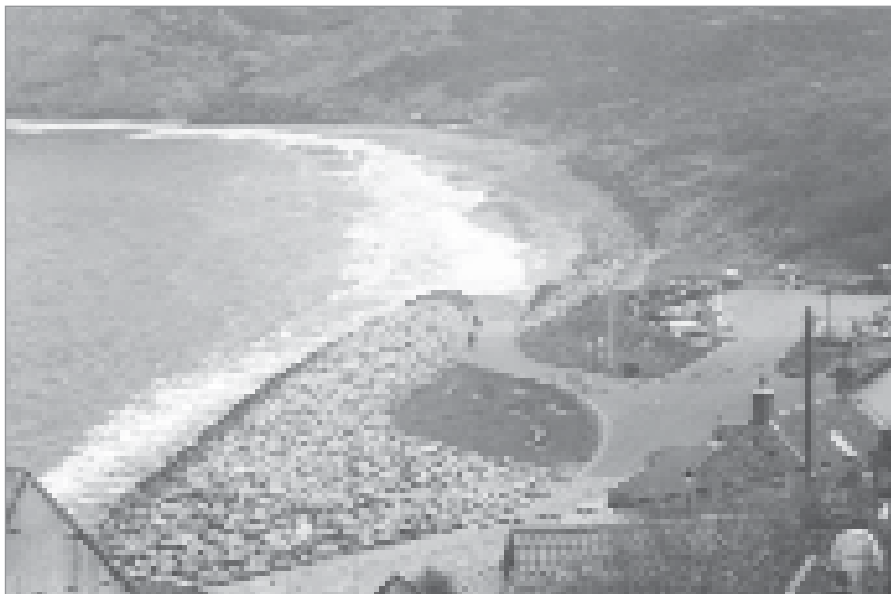

Figure 6.66 Access ramp through rock revetment (Runswick Bay, UK) (courtesy Halcrow)

Flank protection

Top edge and flank protection are needed to limit the revetment's vulnerability to erosion continuing around its ends. Care should be taken to ensure that the discontinuity between the protected and unprotected areas is as small as possible (use a roughness transition) so as to prevent undermining. For example, open cell-blocks or open blockmats (eventually vegetated) can be used as the transition from a hard protection to a grass mat.

With flank protection, extension of the revetment beyond the point of active erosion should be considered but is often not feasible. In such situations, **terminal or bastion groynes** and protective flanking or cut-off walls cut into existing land perpendicular to the line of defence may be required to protect against erosion, as shown in Figure 6.67. These often only provide a temporary solution and require extension from time to time to match the rate of erosion or accretion.

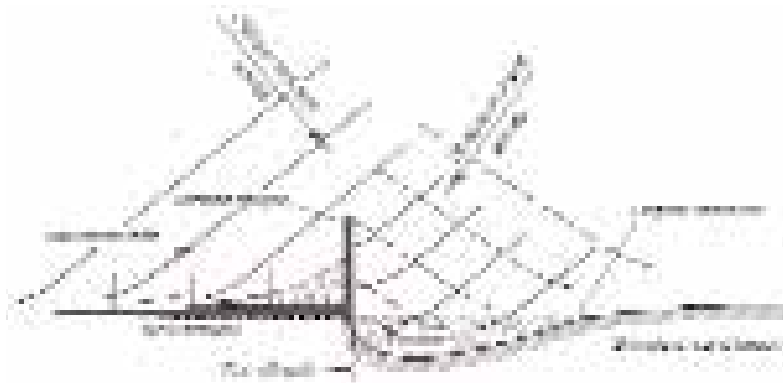

Figure 6.67 Erosion at seawall termination

6.3.4.4 Structure-specific aspects

Revetment protecting a seawall

The cross-section of a seawall protected with armourstone will depend on the actual situation and the functions required of the revetment. A number of basic concepts are identified here that can be used to develop site-specific solutions. These basic concepts are illustrated in Figure 6.68, which shows various forms of revetments protecting seawalls.

Sometimes the existing arrangement at a particular site may impose severe geometrical constraints on a solution involving a revetment or revetted mound. For example it may be necessary to incorporate an existing seawall structure into the solution. Alternatively, there may be a requirement to incorporate a roadway or promenade into a sea defence structure, Figure 6.69. Fortunately, armourstone offers flexibility in this situation because of the range of gradings and densities available.

For the cross-section design of a particular armourstone revetment, the principal functional failure criteria can be summarised as flow under, through or over the structure. Other failure modes could be damage to, or displacement of, armour or geotechnical instability. It is therefore vital to consider the potential failure mode of the site in question. Geotechnical stability and flow under or through a mound comprising (or faced with) stones can be assessed using the information supplied in Sections 4.4 and 5.4.

A case study of a revetment protecting a seawall at Corton in the UK is given in Box 6.8.

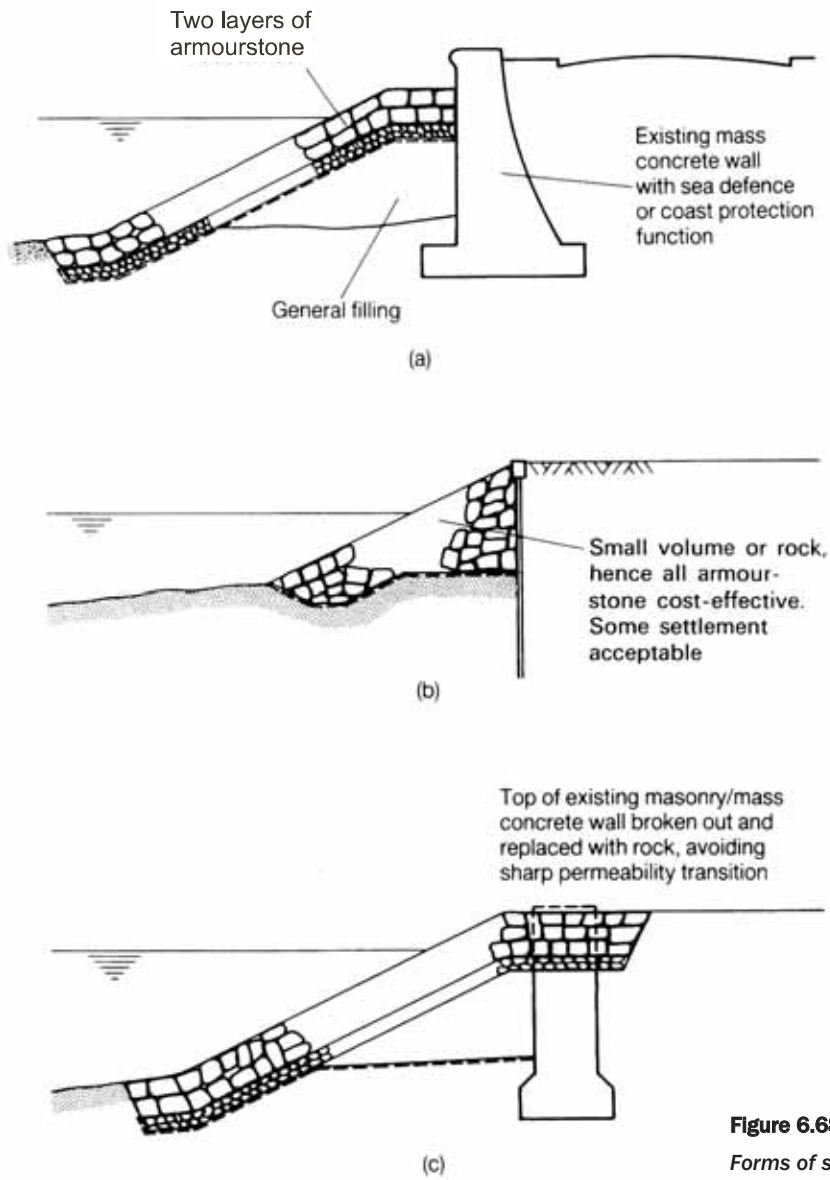

Figure 6.68
Forms of seawall protection

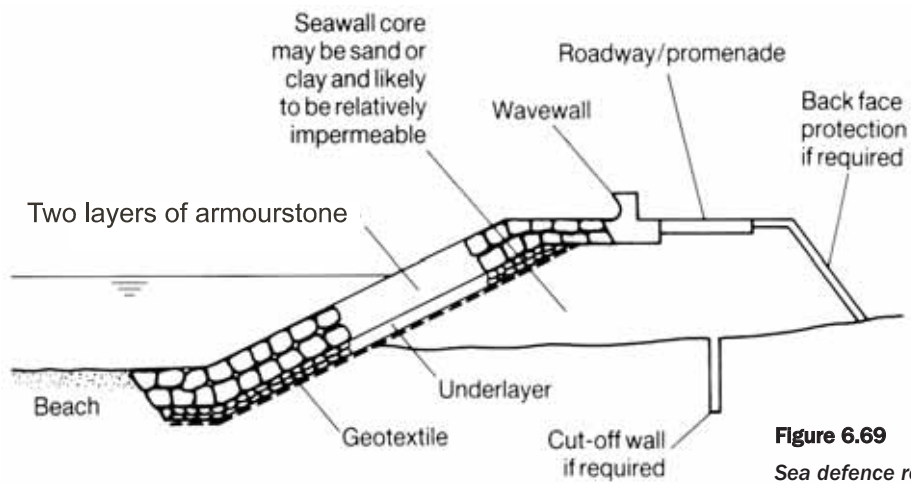

Figure 6.69
Sea defence revetment

Box 6.8 Case study – Corton coast protection scheme, UK

Problem: The existing seawall protecting a stretch of 1.5 km of erodible cliffs at Corton on the Suffolk coast in the UK, constructed in the 1960s, was in need of repair. Lowering beach levels and degrading seawall condition led to a scheme being implemented. The lowering beach levels reduced the stability of the seawall and failure of sections of the wall occurred in the winter of 2000.

Solution: The solution was to construct an armourstone revetment in front of the seawall to provide protection against wave attack, to provide additional mass at the toe of the wall to improve stability, and to act as scour protection. The armourstone grading was 3–6 t. Figure 6.70 shows the cross-section. The revetment consisted of two layers of armour laid on a geotextile. The slope of the armour varied from 1:2 to 1:3, depending upon location. Figure 6.71 shows the construction work.

Costs: The total cost was £2.8 million and the repairs were carried out in 2003.

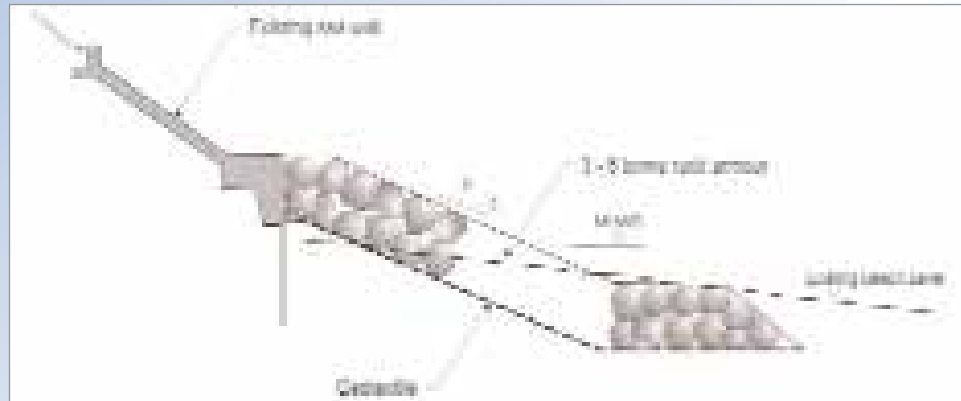

Figure 6.70 Typical cross-section of revetment at Corton, UK (courtesy Halcrow)



Figure 6.71 Construction of Corton coast protection scheme, UK (courtesy Halcrow)

Note: see Sections 6.3.3.6 and 3.16 for discussion on the use of geotextiles and their appropriate specification depending on the armourstone sizes being used.

Revetment protecting an existing embankment or cliff/dune system

The cross-section of the revetment will depend on the actual situation and exposure to overtopping and the effects on cliff/dune or road structures behind. Examples of typical cross-sections are shown in Figure 6.72. Figure 6.73 shows a soft cliff protected by a rock revetment. In this case, it was important to protect assets on top of cliff by ensuring that overtopping of the crest was such that no further erosion of the soft cliff took place.

Important considerations for such locations are:

- erodibility of cliff or sand dune material
- accepted retreat rate (if retreat is allowed)
- crest height needed to protect the cliff face from overtopping
- general layout issues covered in Section 6.3.2.1.

Guidance on cross-section design is given in Section 6.3.3.

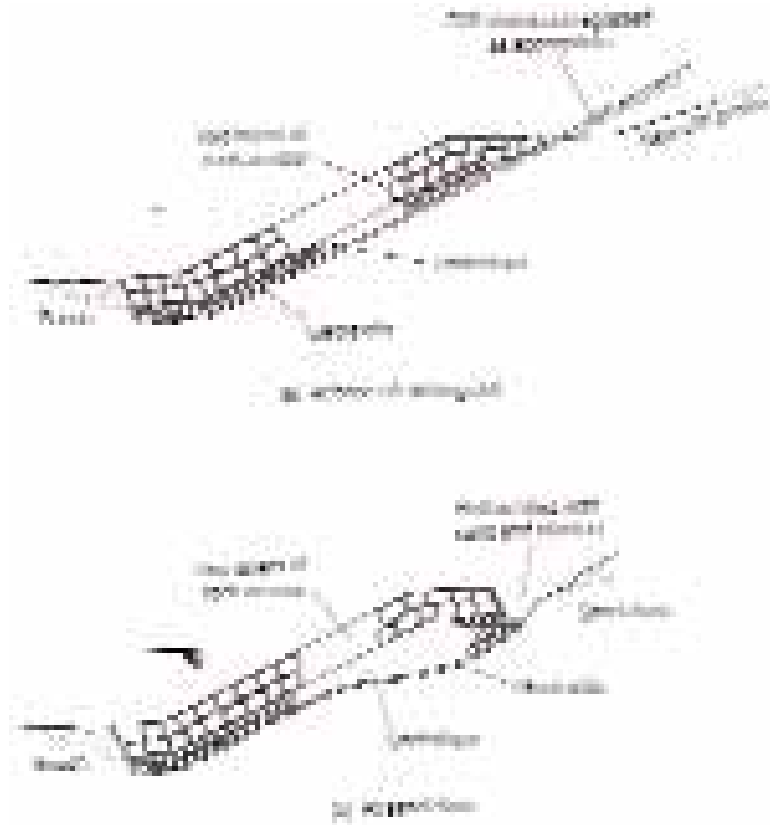

Figure 6.72 Coastal protection revetments

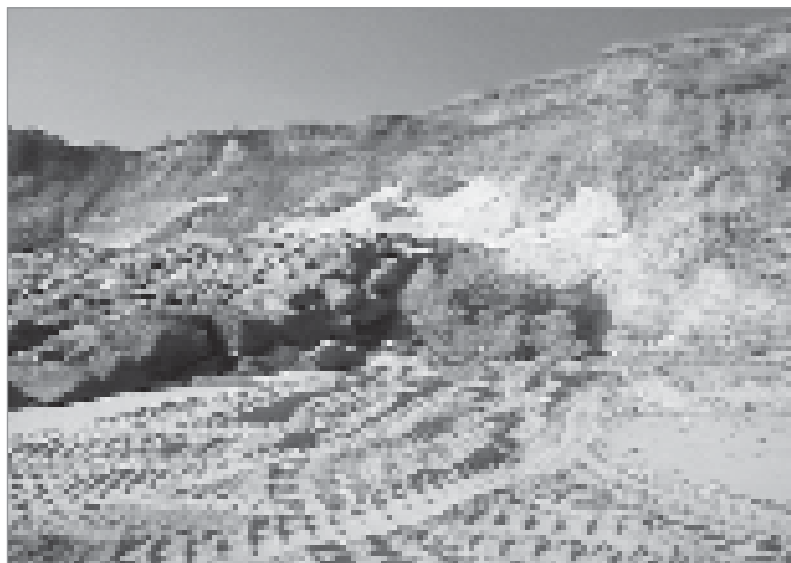

Figure 6.73 Rock revetment protection to cliff toe (courtesy Halcrow)

Revetment protecting reclamation

Where rock revetments are constructed to protection reclamation schemes, the potential for flow of air and water through the revetment needs to be considered. Figure 6.74 shows a typical cross-section.

There have been many examples of failures involving leaching out of reclamation material and consequent sinkhole formation arising from poor filter design and failure to properly vent the fluctuating wave pressures. Guidance on cross-section design is given in Section 6.3.3.

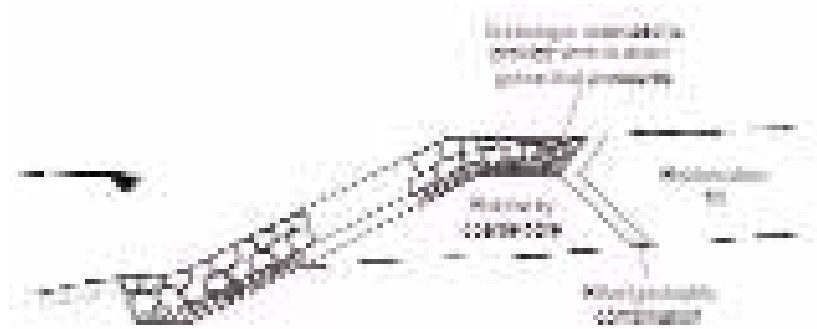

Figure 6.74 Revetment protecting reclaimed area

Scour protection at vertical wall

The technical considerations for design of rock scour protection at a vertical wall are similar to those for the protection of breakwaters discussed in Section 6.1. The stability of the anti-scour armour may be assessed in a similar way using the information in Section 6.2. Design principles are otherwise generally similar to those for revetments.

Groyne

The cross-section of a simple, small groyne may be made up of a single grading of armourstone, which may be wide-graded ($D_{85}/D_{15} > 2.5$). Larger stones from the grading may be set to one side during construction for placing on the outer part of the groyne, to give additional protection where greater wave energy may be focused. For larger structures, small bedding stone layers may be introduced. Figures 6.44 and 6.76 show rock groynes in various locations and of various forms.

The level of complexity of the cross-section will be a function of site accessibility and maintenance resources available (see Chapters 9 and 10). A single narrow armourstone grading placed directly on to the beach may experience some settlement and a consequent need to add further stones in the future. However, the capital cost savings involved may be cost-effective if replacement stones can be readily sourced and placed.

The crest level should generally follow the existing or proposed (nourished or trapped) beach profile (type 1 in Figure 6.75). This beach profile will vary with the season (summer or winter), weather condition (storm or calm) and changes resulting from onshore/offshore sediment movement. However, the crest should not normally exceed the maximum beach level expected at any position. This can be calculated using sediment transport models or formulae. Sometimes it may be appropriate to keep the crest level constant (type 2 in Figure 6.75), particularly for short groynes, and here it should not normally exceed the height at which a storm ridge would exist at the site.

The suggested crest levels and profiles should ensure that beach material is not unnecessarily retained on one side of the groyne, thereby starving the downdrift beach. The selected longitudinal profile will influence the location of the zone of most severe wave attack along the structure, as illustrated in Figure 6.75, and particular care should be taken when designing these zones for hydraulic stability.

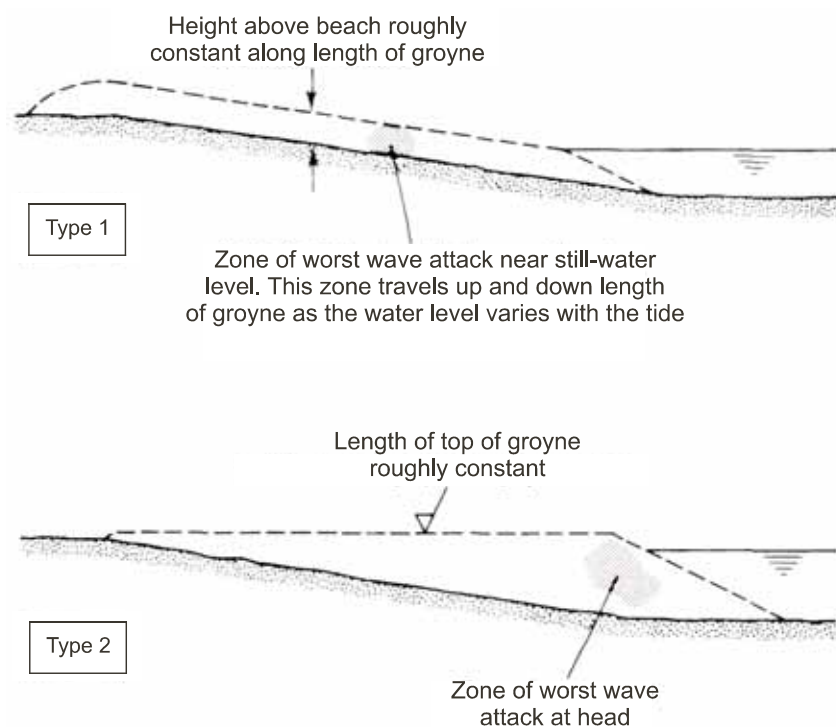

Figure 6.75 Alternative groyne profiles (from Simm et al, 1996)

Side slopes of simple groynes may be largely dictated by economy, and slopes as steep as 1:2 or even 1:1.5 are used. The primary advantage of flatter slopes (say, 1:3 to 1:4) is the reduced wave reflection that arises and the increased diffractive capability to encourage sediment to build in the lee of groynes. In addition it is possible to use smaller stone sizes with shallower slopes. Particular attention should be paid to the transition between rock groynes and existing impermeable hard defences.

It is advisable to ensure a proper transition in terms of permeability/porosity by ensuring filter criteria are met (see Section 5.4.3.6). A relatively economic way of achieving this transition is asphalt grouting of a small area of the groyne armourstone immediately adjacent to the hard defence.

A case study where rock groynes were used to prevent flooding in a coastal situation is given in Box 6.9.

Box 6.9 Case study: rock groynes, Shoreham, UK

Problem: The existing sea defences (see Figure 6.76) protecting a 4 km length of coast at risk from flooding were deteriorating and being overtopped frequently, causing flooding and damage to assets, and posing a risk to life. Based on existing estimates of sea level for the area, it was apparent that overtopping of the defences would increase with time, resulting in considerable damage to local infrastructure and assets.

Solution: The solution was to recharge the beach in conjunction with construction of 33 rock groynes along the frontage to provide the required standard of protection against overtopping. The rock groynes are 70 m long, with armourstone grading of 4–8 t. The groynes incorporate a layer of geotextile laid on to beach material, a core layer and two layers of primary armour. The side slopes of the structures are 1:1.5. The beach material is shingle (gravel) and the toe detail allows for anticipated draw-down of the material.

Costs: The project has been phased over three years, with phases 1 and 2 having a value of £12 million. Works for these phases began in 2003 and continued until 2005.

Figure 6.76
Case study: rock groynes,
Shoreham, UK (courtesy Halcrow)

**Detached breakwater**

General breakwater design and construction is discussed in Section 6.1. Where detached breakwaters are used for coast protection, the failure mode evaluation and cross-sectional design procedure described in Section 6.3.3 should be followed. The function of encouraging beach build-up may have more influence on cross-sectional shape than pure stability considerations for conventional breakwaters.

Typically, the outer face of such breakwaters should have a slope of around 1:3 or 1:4 to reduce scour caused by wave reflections and to increase energy dissipation. The rear face can be steeper. If reflections and scour can be accommodated, then steeper slopes on the front face may also be acceptable. Crest levels will be set by overtopping limits (see Section 5.1.1.3) or by wave transmission criteria (see Section 5.1.1.4) or, in the case of dynamically stable reef breakwaters, by wave-structure interaction (see Section 5.2.2.6). Figure 6.77 shows offshore breakwaters with salients at Elmer in the UK.



Figure 6.77 *Detached breakwaters, Elmer, UK (courtesy Environment Agency)*

Roundhead design

Roundheads on the ends of rock structures represent a particular stability problem. Waves breaking over a roundhead can concentrate and significantly increase exposure and instability, especially on the lee side of the head.

To deal with this and provide the same stability as for the main trunk section, it is usual to flatten the slope, increase the armour mass, or both.

General considerations and guidance on the design of breakwater roundheads are covered in Section 5.2.2.13 and also covered in Section 6.1.4.1.

The transition between breakwater and beach can be smoothed still further by the introduction of a spending apron of bedding/underlayer stone, as in the case of the breakwater constructed at Leasowe Bay, UK (Barber and Davies, 1985).

Fishtail groyne

The design of the cross-section of the various parts of a fishtail groyne involves a combination of the concepts discussed above for groynes and offshore breakwaters. For a description of the various parts of the breakwater, reference should be made to the basic geometry diagram shown in Figure 6.78 (see also Figure 6.53).

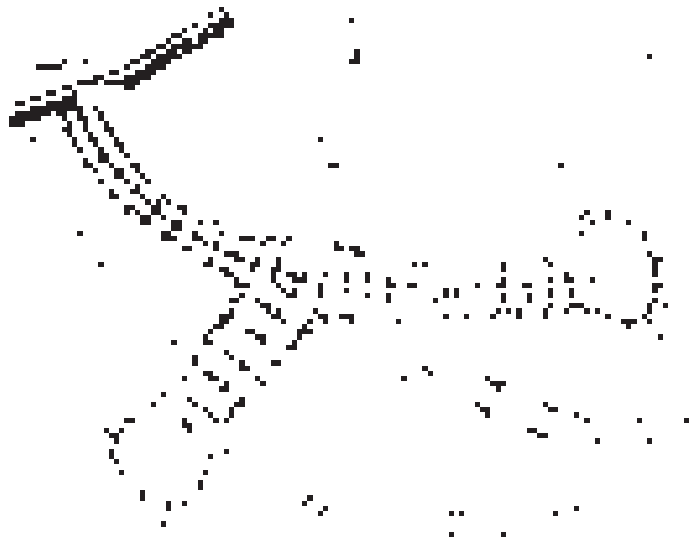

Figure 6.78 *Fishtail groyne geometry*

- **Land link (OC in Figure 6.78)**

The crest of the land link, which prevents tidal currents from flowing behind the main arms of the structure and eroding the beach, is, as with groynes, normally set to follow the profile of the beach. Side slopes are typically set at about 1:2, again as for conventional groynes.

- **Down-drift outer arm (OB in Figure 6.78)**

As the main function of the down-drift outer arm is to intercept storm waves and protect the down-drift beach from direct wave action, its crest is generally set above high tide level, but with a fall from O to B to assist in a smooth transition back to beach level.

Side slopes for the down-drift outer arm should normally be set at about 1:4 on the outer face exposed to the prevailing storm waves, but can be reduced to 1:3 on the more sheltered inner face. Slopes as steep as 1:2 should be avoided, as these will cause undesirable reflections compared with flatter slopes and will not have the required energy-dissipating properties to assist in sand accretion.

- **Up-drift outer arm (OA in Figure 6.78)**

As the primary function of the up-drift outer arm is to intercept alongshore and tidal currents and divert them sufficiently far offshore to minimise beach erosion within the protected cell, the crest level of this arm can be lower, tidal currents being most severe in the mid-tide range. Indeed, if crest levels are set too high, undesirable silt patches between AOC and the shoreline may form.

L- and T-shaped groynes

These may be designed as conventional groynes. Their application to areas of limited tidal range means that crest level definition is relatively straightforward. Side slopes for the outer L or T will be between 1:3 and 1:6 for the reasons discussed for offshore and fishtail groynes above.

The land link arm can have side slopes as steep as 1:2, except for the outer face of arms that do not have a pocket or protected beach at either side of them. Figure 6.79 shows typical T-shaped groynes used to hold a beach in place.



Figure 6.79 T-head groynes, Rhyl, UK (courtesy DEFRA/Halcrow)

Sill or submerged breakwater

Armour stability, side slopes and cross-sectional details of sills or submerged breakwaters can be assessed using the information on stability in Section 5.2.2.4. The design will be strongly influenced by the selected crest level, determined by the required profile of the beach to be retained. Insufficient data is available to give clear guidance on crest level in relation to beach profile, and model tests are always advised. However, based on an assessment of work by Beil and Sorensen (1989), a starting point for design may be to set the crest level such that the height of the sill crest above the original beach level is about twice the height of the sill above the final beach level ($h_f - h_s$). The parameters are described in Figure 6.80.



(a) Definition sketch for rock sill and associated sand beach of relatively mild slope (Dean, 1988)

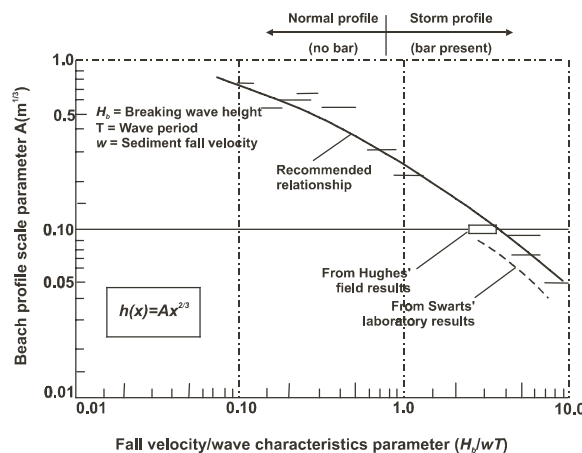

(b) Correlation of equilibrium beach profile scale parameter, A, with combined sediment/wave parameter H_b/wT (Dean, 1987)

Figure 6.80 Rock sill design parameters (Dean, 1988 and 1987)

Documented applications of sills are limited, but a model-tested design for a sill and perched beach at Lido di Ostia, Rome, is shown in Figure 6.81 (Toti *et al*, 1990). Stability of relatively deep sills may also be evaluated with the guidance in Section 5.2.2.5.

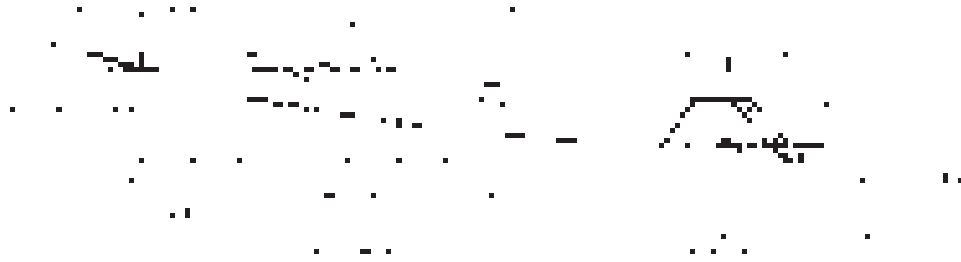

Figure 6.81 Sill and perched beach design (Toti *et al*, 1990)

6.3.5 Cost aspects

Cost aspects should be considered during the design phase. Cost estimation associated with different stages in a project is discussed in Section 2.4. In preliminary design total costs can be estimated with unit rates and quantities (see also Section 6.1.8 on cost aspects for breakwaters).

Coast protection rock structures often differ from breakwaters in that they may form part of a system, working together with other components to provide the required function, for example rock protection to a seawall or rock groynes as part of a beach recharge scheme. There may therefore be scenarios where damage to the rock structure will not result in catastrophic failure, and this may be taken into consideration in the design.

Coastal schemes have been developed to satisfy different functional and performance requirements at particular locations. Design techniques have sometimes been used as for large harbour breakwaters, but schemes have also been developed on the basis of trial and refinement, often using locally available materials.

Research in the UK has considered examples of low-cost rock structures around the UK coast that depart from standard design guidance (Crossman *et al*, 2003). The report identifies opportunities for deviating from standard guidance to produce low-cost rock structures and identifies advantages as including easier construction, improved construction safety, reduced environmental impact and more adaptable structures; see Box 6.10.

For coastal schemes rock is usually required in smaller quantities than for large breakwaters. The rock used for these structures is therefore typically a by-product from aggregate quarries, while for large breakwaters often a dedicated quarry is utilised and structure cross-sections are optimised to make best use of the quarry yield (see Section 6.1.8.1).

As the rock used for coastal schemes is commonly a by-product of quarrying for construction materials, its availability and cost is variable depending on the quantity stockpiled at a particular quarry at a certain time. Such quarries may also only be able to supply a limited grading or poor-quality material, and may experience difficulty in producing material at the rate required for economical construction. This not only applies to the larger stone sizes used in armour layers, but also to the smaller stone sizes used in underlayers.

It is clearly important that the design basis and any long-term maintenance requirement is understood and accepted by the owner at the outset. Opportunities are discussed further in Chapter 10, which includes case study examples.

Box 6.10 Guidance for low-cost rock structures (after Crossman et al, 2003)**Design changes that may reduce the cost of coastal rock structures****Less material**

The size and shape of rock structures (their *geometrical design*) is determined primarily by functional and performance requirements, eg the degree to which a beach is protected or the proportion of longshore transport trapped by a groyne. Within the geometrical envelope some aspects of the structure design are dependent solely on the size of the rock armour: for example, the layer thickness and crest width are often defined as two or three armour stones. If analysis of alternative structural configurations (such as the introduction of a more permeable core) can allow use of a smaller grading of armourstone, the volume of rock required can be significantly reduced, providing cost savings and reducing environmental impact.

Parts of the structure may be constructed with alternative (lower-cost) materials (see Section 3.13). This might involve the construction of the core of the structure from waste materials, eg old car tyres, or use of composite structures where armourstone is used for some parts and other structural configurations adopted where they provide savings (such as vertical timber or steel panels at the landward end of a groyne). The increased monitoring and adaptability of rock structures may also allow less conservative designs, initially using only the minimum quantity of armourstone expected to provide the required performance in the knowledge that the structure will be monitored and can be enhanced if required.

More efficient construction

Careful design and detailing of rock structures can reduce construction time and costs. The use of simpler cross-sections with fewer gradings of armourstone will reduce the number of construction operations and the degree of checking required, and will accelerate construction. The use of a single grading of armourstone can also minimise the risk of damage to unprotected parts of the structure during construction, compared with a multi-layer system where the underlayer(s) may not be of sufficient size to resist damage during storms that may occur when the structure is only partially complete.

Reduction and appropriate allocation of risks can lower costs. Examples of this approach are reducing the contractor's risks by agreeing to payment by mass of armourstone or ensuring clear definition of construction requirements at the start of the project (eg use of a trial panel to confirm requirements for placement and packing, see Section 9.8). Construction duration often has a significant impact on construction costs and, where possible, opportunities should be sought to maximise use of plant, for example with 24-hour and tidal working. If this is not practical for all of the works, then it may be acceptable for at least the most restricted or critical elements, such as those that require use of a particular piece of plant or need a particular tidal window.

Cheaper rock

The cost of armourstone supplied to site can vary widely. Greater choice of supply will increase the likelihood of obtaining economic materials. Choice can be broadened by limiting the maximum armourstone size and developing alternative designs to accommodate constraints imposed by local quarries.

Where local quarries are close to the site armourstone may be obtained at lower cost, although this may not meet quality, grading and production rate requirements. These concerns may be overcome by, for example, stockpiling armourstone before starting the works, widening the grading to utilise a greater proportion of the quarry yield or relaxing quality requirements and making provision for the supply of additional armourstone during the life of the works. Where there is difficulty in obtaining sufficient volume of the largest grading, selective placement may be adopted by placing the largest stones in locations where greatest damage is expected or where stability is most critical (eg the crest of overtopped structures, the toe or the outer end of a groyne).

Reducing excavation

Excavation for the toe or other foundation of rock structures in shallow water is a difficult and expensive operation. Excavation at sea by marine-based plant should therefore be avoided where possible.

There is potential to make significant savings in excavating with land-based plant. Costs can be high, as excavated trenches often contain water and gentle side slopes or strutting and propping are required to ensure stability. Excavations on beaches can infill rapidly on high tides as sediment is washed in by waves and currents, meaning that construction of rock structures in excavations often needs to be carried out in short sections, with excavating and stone placement on the same tide. Working in such short sections is inefficient and time-consuming. The deeper the excavation, the more water it is likely to contain, increasing time, cost and safety risks. Development of designs that minimise excavation can therefore provide significant savings – see for example toe details without excavation in Section 6.3.4.1.

6.3.6 Construction issues that influence design

Even at concept stage the designer should consider the possible method of construction before designing any form of structure. Usually, the simpler the design, the faster and cheaper it can be built. It is recommended that an experienced marine contractor be involved in the design process to advise on current methodology for constructing the form of structure proposed. See Chapter 9 on construction for further guidance.

Key construction considerations in shoreline protection design include the following:

- availability of materials – colour, size, gradation etc may influence the choice of armouring (for example concrete or rock, see Chapter 3) and shape of structure (adoption of less steep slopes)
- local construction resources – if the quality of construction is questionable, allowance should be made in design sizing and tolerances
- best use of materials – the exact dimensions of a structure should ideally be proportioned to optimise the use of armourstone gradings obtained by quarrying; consider tailoring design to suit local material availability (see Chapter 3 and Box 6.10).
- access limitations to the frontage and ease of construction – the tidal range, ground conditions and access points are relevant; productivity may be lower in winter when working in the dark and during inclement weather
- type of plant – maximum reach of plant, particularly in placing large armour units; construction from a barge can take twice as long as from the crest; ample working space is needed
- trafficking of plant – provision of a crest wide enough at a construction level above water level to enable plant movement, material supply and crane manoeuvrability; inclusion of passing places as features in final construction; and general safety considerations
- keeping details uncomplicated – in terms of armourstone layers etc and minimising the number of different construction activities
- establish whether environmental designations will influence the choice of construction techniques or delivery of materials – eg if the foreshore is a designated area then the landing of material delivered by sea may be restricted
- offshore bathymetry and tide levels – contribute to contractor's selection of the method of delivery and establishment of working windows for plant and deliveries
- use of geotextiles – needs to be assessed and special consideration given where:
 - construction is in high currents or in exposed wave environments
 - vessels may manoeuvre in shallow water adjacent to the construction, as there may be a danger of propellers being fouled on loose geotextiles
- use of rock – needs to be assessed and special consideration given where light vessels such as yachts are manoeuvring in shallow water and there is a possibility of damage to hulls, eg at the entrance to a harbour. Large sand-filled reinforced bags may be considered to offer a soft alternative to rock
- lifting eyes in individual armour stones – should be avoided if at all possible in favour of use of larger hydraulic machinery.

Physical modelling, used to verify final designs, can also be used to evaluate the risks on partially completed sections of a structure. This is a very important where work is to be undertaken during winter months because the partly completed structure will be exposed to risk of damage from waves and surges.

While construction issues should play a key part in determining the design, these should not be allowed to compromise or unduly dictate the final design unless benefits to both parties can be established (invariably cost).

Further construction considerations are detailed in Chapter 9.

6.3.7 Maintenance issues that influence design

Maintenance considerations and techniques are discussed in depth in Chapter 10. When selecting an appropriate type of cross-section for the seawall or shoreline protection structure, it is important to recognise that maintenance will be a small-scale operation that will be carried out most economically by land-based plant. Thus the access provided from the shore by the structure layout will have a crucial influence on the design approach to the armour layer.

The accepted level of damage for which the structure is designed (damage level, S_d , see Section 5.2.1) will also influence the frequency of maintenance works and is an important consideration at design stage.

It is important that any structure can be maintained safely and adequate access is provided for all plant and equipment needed for any maintenance and upgrading planned in the design life of the structure.

For example, a client may require there to be no damage for a 1:50-year event ($S_d = 2$), whereas for a 1:200 year event it may be acceptable to have some minor damage to the structure (S_d varies with according to slope) that may require replacement of stones at the toe or crest but does not result in catastrophic failure. Stability formulae in Section 5.2.2.2 can be used to design to these requirements.

Clients need to be made aware of these issues and be involved in the decision-making process regarding maintenance requirements from the outset of planning and design.

6.3.8 Repair and upgrading

Rock armour is commonly used for the repair and upgrading of existing structures. Care should be taken to integrate the repair with the existing structures so that the two forms of construction do not give rise to localised weakness at transitions or to concentrated wave loads, greater overtopping or accelerated scour.

Topping up existing rock structures with additional rock can necessitate considerable work in dismantling the existing structure to a point where satisfactory interlocking of individual rocks can be achieved. It is therefore recommended that the designer takes advice from contractors before adopting this technique and is aware that the costs associated with this apparently simple operation can be considerable.

Repairs to existing seawalls, for example using armour as a revetment or scour mattress, should be undertaken with the rules and guidance of Chapters 4 and 5 in mind.

As-constructed or as-built drawings are very useful in providing construction details of structures that are to be rehabilitated or enhanced. In many countries it is a legal requirement, and in others it is considered good practice, that these drawings are produced upon completion and handed to the client for safe-keeping to be used in such situations and during maintenance.

6.4 ROCKFILL IN OFFSHORE ENGINEERING

This section discusses the use of rockfill in offshore engineering, particularly rock protection and stabilisation of pipelines and cables, as well as the design of bed and scour protection for offshore structures in general.

In this section the term “offshore” does not necessarily imply deep-water conditions, but instead essentially refers to rock works constructed using marine-based, rather than land-based, equipment. They include, among others:

- rock protection to pipelines and cables
- scour protection of slender structures such as monopiles (offshore wind farms)
- scour protection and bed preparation for massive structures such as concrete gravity structures (CGSs).

Figure 6.82 provides a schematic overview of these types of rock works to offshore structures.

This section begins with a description of aspects that must be considered when designing any offshore rock structure. This is followed by descriptions of the aspects requiring attention for rock protection of pipelines and cables and concludes with specific considerations for the design of scour protection structures. Design calculations for the various structures are based on methods described in Chapter 5. In particular the reader is referred to the following:

- near-bed structures exposed to waves – Section 5.2.2.5
- scour protection against waves – Section 5.2.2.9
- bed protection against currents – Section 5.2.3.1
- near-bed structures exposed to currents – Section 5.2.3.2
- scour protection against currents – Section 5.2.3.3.

References to other relevant design guidance are also given where appropriate. Construction aspects including common types of equipment and construction methods are described in Chapter 9.

6.4.1 General aspects and definitions

The rock structures commonly applied for the protection of the offshore structures listed above generally consist of graded berms, placed either on the sea bed or in a trench for the case of a pre-trenched pipeline or cable. Schematic diagrams of common rockfill applications are shown in Figure 6.82.

The design of these structures will usually involve a prediction of the amount of scour that will occur before and/or after construction. The reader is referred to Section 5.2.2.9 and also to standard handbooks on scour such as Hoffmans and Verheij (1997), Schiereck (2001) and Whitehouse (1998).

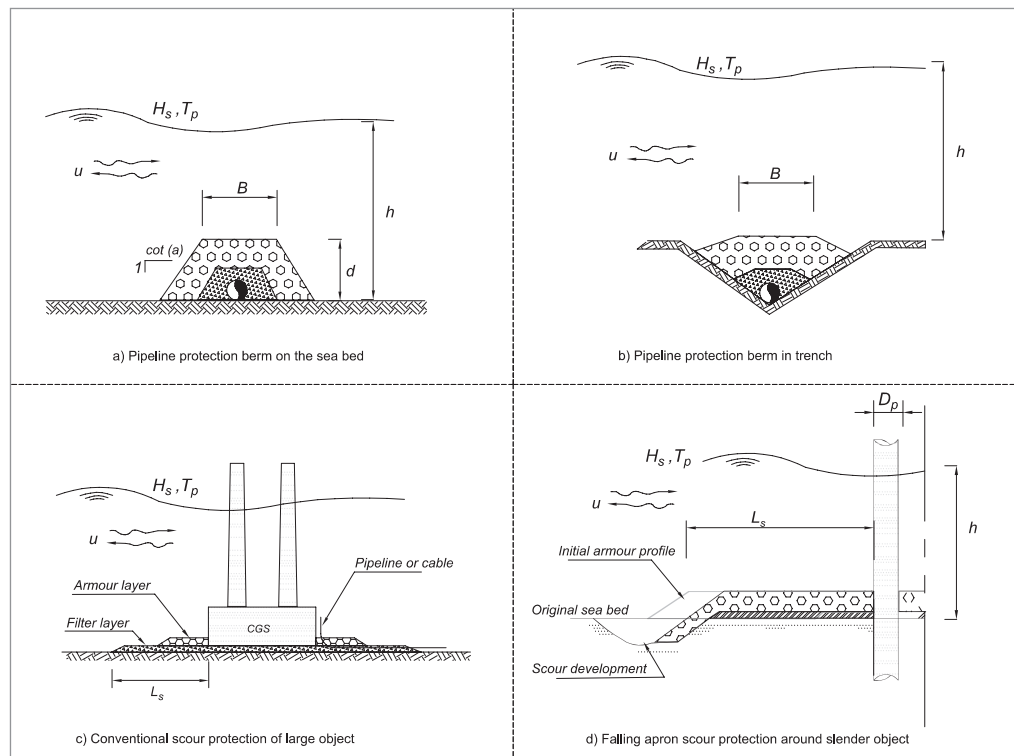

Figure 6.82 Schematic diagrams of offshore rock structures

6.4.1.1 Pipelines and cables

It is often necessary to protect offshore pipelines and cables because an incident might result in:

- the release of the pipeline's contents, causing serious environmental damage
- high repair costs
- a loss of income in the period between the accident and the final repair
- reduced life expectancy for the structure.

During operation offshore pipelines can be subject to the following hazards:

- hydrodynamic forces from the action of waves and currents
- geotechnical instability of the berm or subsoil
- morphological changes (sandwaves)
- dropping or hooking by ship anchors
- hitting or hooking by fishing gear.

Additionally, pipelines can be at risk from the following hazards:

- dropped objects (containers, tools), especially near platforms
- overstressing and vibration of pipelines caused by freespan development. These freespans can be caused by scour of the sea bed or rapid morphological changes of the sea bed (sandwaves)
- buckling, caused by thermal expansion of pipelines
- waxing within pipelines as a result of a temperature drop along the pipeline
- decreasing viscosity of the transported substances, caused by, among other factors, a temperature drop along a pipeline.

To protect pipelines and cables against these hazards rock berms are often applied. This can be done either by placing a continuous berm along the length of the pipeline or cable or, in some cases, by a series of individual berms at a specified spacing. The latter case is applicable where the hazards of anchors, fishing gear and dropped accidents will not occur.

6.4.1.2 **Slender structures (monopiles)**

Scour protection is often necessary for slender structures such as monopiles for offshore wind farms. Offshore wind farms are increasingly being proposed for and constructed in environments with severe hydrodynamic conditions. For their operation to be reliable and cost-effective, turbine monopiles need to be optimised to allow for the ambient environmental conditions.

Many potential sites for offshore wind turbine farms are located on sea beds with mobile sediments. In these cases, allowance needs to be made for the interaction of the sediments with the turbine support structure. In particular, the soil mechanics aspects of the foundations and the effects of flow-induced scour at the base should be evaluated. Scour can potentially be detrimental to the stability and lifetime of the structure due to fatigue caused by resonance behaviour of the monopiles. This is partly dependent on the design of the scour protection. Important aspects for the resonance behaviour are the embedded length of the monopile in the sea bed and the height of the rockfill surrounding the pile.

6.4.1.3 **Concrete gravity structures (CGSs)**

Concrete gravity structures are characterised by being quite large relative to the water depth. The flow patterns around the structure and thus the scour patterns and required scour protection differ from those of a slender structure. Another feature common to CGSs is the presence of pipeline and/or cables connecting to the structure. The protection of such features and their interface to the rest of the structure will also require attention. The situation is highly three-dimensional and design and optimisation of the protection may require detailed physical and/or numerical modelling.

In addition, the foundation of the CGS should generally be level and free of pinnacles or other objects that could induce high local stresses in the structure. To ensure this a bed protection of small rock is sometimes required.

6.4.2 **Layout**

Although the stability of the various types of structure described in this section is highly influenced by three-dimensional effects, the calculations for a conceptual design of the rock protection are usually based on a two-dimensional approach. No specific aspects regarding the layout of these structures are therefore considered in this manual. When more detail is required three-dimensional situations may be considered by use of numerical and/or physical models.

6.4.3 **Design aspects**

The design of protection measures built up with armourstone requires a balance to be struck between the extent and consequences of possible damage to the structure if no protection is applied (and the subsequent repair costs) and the initial costs of the protection measures. The basic issues to be dealt with are the stone grading and layer thickness required to guarantee the stability of the structure and the required horizontal extent of the protection.

The protection measure should meet the following requirements:

- the external stability of the protection should be adequate, which means that the protection should remain stable under the specified design conditions
- the internal stability of the protection should be adequate, which means there should be no loss of bed material through the protection
- the protection should be able to adjust itself adequately to the foreseen bed level fluctuations near the edge of the protection.

The design of a rock protection system is based on the stability of the armourstone under the hydraulic and other external design conditions as well as the internal stability of the filter material. This last item is assessed using the standard filter rules (Section 5.4.3.6). The design of the protection can be separated into the following issues:

- grading of armourstone (for a stable top layer under the design conditions)
- grading of filter layer(s) (to prevent the seabed material from washing out through the armourstone)
- thickness of each stone layer (to prevent the seabed material from washing out through the stone layers)
- horizontal dimension of the scour protection (to secure the soil at sufficient distance from the structure, required for stability of the foundation).

For rockfill structures, after the required environmental design data have been determined (see Chapter 4) the design methods in Chapter 5 can be used to derive the required armourstone grading that will provide a stable protection under the extreme design circumstances.

To determine the stability against hydraulic loading, the formulae listed in Section 5.2 can be used (see specific cross-references at the start of this section). These formulae contain influence factors for the combined loading from current- and wave-induced action and yield a certain minimum stone size required for stability. The various design formulae listed in Section 5.2 have generally been derived for specific conditions; when designing such structures the results from different formulae should be compared. The final determination of the armourstone grading still requires the use of engineering judgement in the evaluation of the results obtained. Solution of some of the equations for the required stone size (or grain size for gravel), D (m), requires the application of a roughness coefficient, k_s (m), which is dependent on the grain size. In some cases this iterative procedure does not converge to a solution (an increased roughness leads to a larger stone size, which again results in a higher roughness). In such a situation the value of k_s has to be limited to an appropriate value (in the order of 0.5 m).

Application of the formulae in Section 5.2 will yield a certain minimum stone size (and an appropriate armourstone grading needs to be selected from that, see Section 3.4) for the structure. However, the design is not yet complete! Based on the product to be protected and the general hazards against which protection is needed, the armourstone or gravel should be placed with a specified geometry over the product. In general, when stones are dumped it will be a rather smooth, parabola-shaped berm. By dumping several layers, with or without overlap, this berm can be shaped to some extent. A design will generally be drawn up as a trapezium-shaped berm, with definitions of berm crest width, slope steepness and cover heights. In reality, the berm will be a smoother representation of the design, with the same volume of material included.

It should be noted that a rock berm has some reshaping capabilities under severe environmental conditions. The stone size calculated is the stable stone size for the designated design current and wave conditions. If a storm exceeding the design conditions occurs, then,

depending on the extent of exceedance, individual stones will start rocking and at a certain time will move from position. These will most probably be the most exposed stones, most likely the stones on the crest. The stones will roll down and settle at the toe of the berm so that the berm becomes somewhat spread out and assumes a flatter shape. This shape, however, has an improved hydraulic stability. The phenomenon will occur only when transport rates of the material are not too high and the stones are able to settle next to the rock berm. If the acting environmental conditions significantly exceed the design conditions, either in magnitude or in frequency, the transported material (gravel or armourstone) may be moved farther afield and will therefore not be available for reshaping the berm. In this case, damage to the rock berm could occur.

6.4.3.1 **Design approach**

The scour protection system is designed following both static and dynamic stability approaches.

Static stability approach (conventional design approach)

With this approach, it is assumed that no movement of individual elements is allowed. This method gives the required dimensions of the individual elements to prevent loss (transport) of protection materials for specified design environmental conditions. The stability of the protection should then be designed against the maximum wave heights and associated wave periods for the specified return period. The maximum load on the structure should be compared with the critical Shields parameter for initiation of motion (see Section 5.2.1).

This approach implies that the protection system will remain stable under the design conditions and that no maintenance is expected during its lifetime, provided that the design conditions are not exceeded.

Dynamic stability approach

The dynamic stability approach allows the initial configuration of the protection system to undergo limited reshaping. Some loss of gravel or armourstone from the structure can also occur and the annual average loss of material needs to be computed. The total loss of the material and profile adjustment is computed for the specified design lifetime of the structure. The final structure profile has to meet the minimum design profile.

Optimisation

Use of both static and dynamic approaches enables an optimal design of the protection system. Traditionally, only the static approach has been used. It generally leads to larger stone sizes, which is not always cost-effective, although no maintenance is required. Use of smaller armourstone gradings may be more cost-effective because construction costs are lower, although it is possible that limited losses of material may occur within the design lifetime. These losses may be compensated for by initially dumping extra materials or by maintenance.

Based on the results of static and dynamic analysis, an optimal stone grading is determined.

Figure 6.83 shows a logic diagram of the entire project process for design and construction of rock protection to an offshore structure.

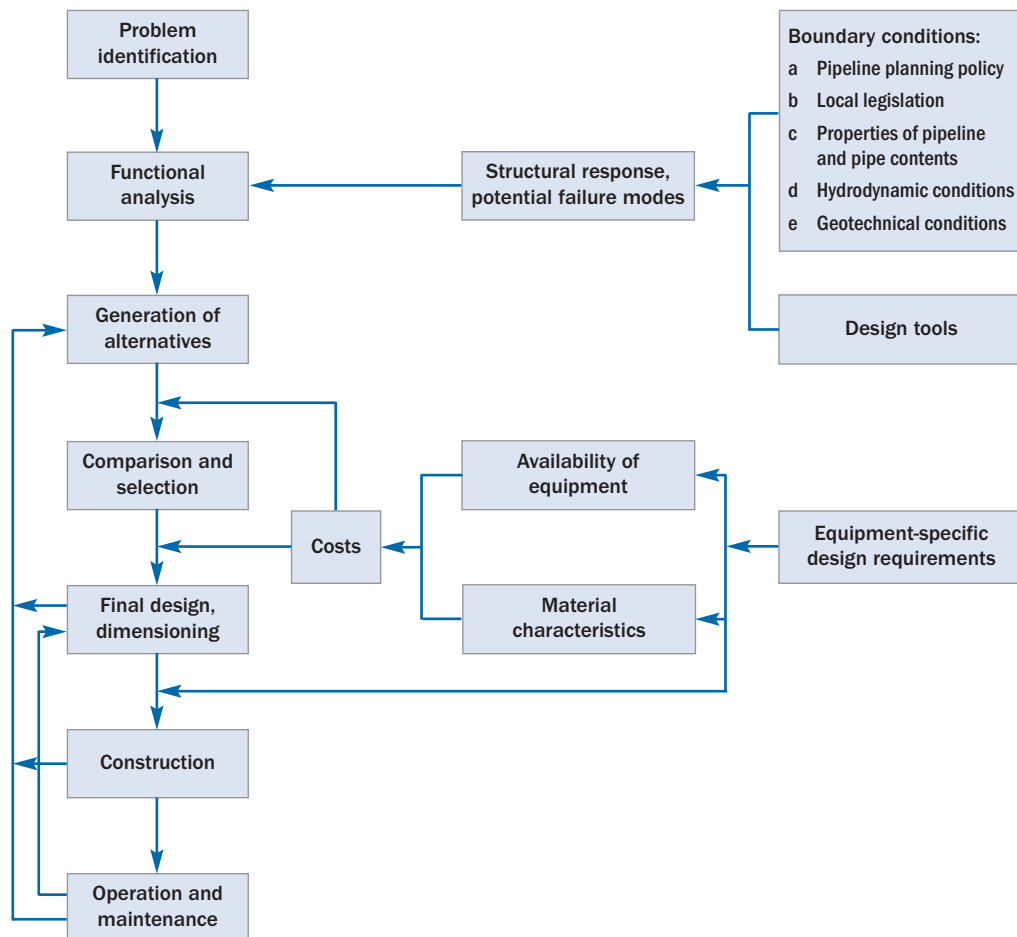

Figure 6.83 Logic diagram of the global design and construction process

6.4.3.2 Hydraulic stability

Gravel and rockfill structures constructed in the offshore zone have to be stable under the action of steady-state (tidal and wind-driven) and wave-induced currents. Traditional design methods based on the *critical shear* or *incipient motion* concept are described in Section 5.2.2 for waves and Section 5.2.3 for currents.

The use of these equations, if applicable, together with a slope angle and induced critical shear stress reduction factors, permits a minimum required grain size, described by the median sieve size diameter D_{50} , to be found. If the structure has such dimensions that the resulting flow conditions can decrease the rockfill stability, separate turbulence calculations should be executed in order to quantify the exerted shear stress.

Section 5.2.2.5 presents a method to quantify the damage level of so-called *near-bed* structures, eg pipeline and scour protection structures. The formulation relates the damage level, S_d (-), to a mobility number, θ (-), and considers the hydraulic boundary conditions of *waves*, *currents* and *waves in combination with currents*. Within the range of validity of the formula the influence of waves is much larger than the influence of currents and in some cases the contribution of currents to the loading can be neglected. Stability calculations for a situation with current only (no waves) are presented in Section 5.2.3.2.

If the works are located in an area with frequent passage of vessels, and in relatively shallow water, the stability of the armourstone under the attack of propeller wash should also be checked. For this the current velocity at the depth of the rock structure has to be determined based on the outflow velocity of the propeller. These processes are discussed in Sections 4.3.4 and 5.2.3.1 and are also reported in PIANC (1997) and Schiereck (2001).

6.4.3.3 **Morphological changes (sandwaves)**

For some offshore structures the influence of large- and or small-scale morphological changes needs to be considered.

Section 4.1.2.2 gives a description of these features. When a structure of small dimensions relative to those of a sandwave is to be constructed on the crest of a sandwave the structure could become unstable when, after some time, the sandwave has (partly) passed. The structure design should take into account the possible presence of the sandwaves and should include measures to prevent the effects after passage. The stability of the structure, when located in areas subject to these features, should therefore be assessed under various conditions that are deemed to be characteristic of the phases of the sandwave development.

6.4.3.4 **Geotechnical stability**

Another aspect in designing an offshore rock structure is the analysis of the possible geotechnical mechanisms of failure. The major mechanisms are (see Section 5.4):

- slip failure of slope and subsoil
- settlement of core and subsoil
- erosion of soil and rock material.

As these mechanisms and other related aspects have been discussed in Section 5.4, only some aspects in relation to offshore structures will be mentioned here.

Calculation of the safety factor against the occurrence of slip surfaces can be executed according to Bishop's method. For pipeline protection structures the relatively low construction height and practical maximum slope angle of typically 1:2.5 are the main reasons that in most cases overall stability is assured.

Internal settlement of the gravel embankment may occur under the densifying influence of wave-induced orbital motions. However, a decrease in porosity is not likely to exceed 4 per cent, while an average decrease of 1–2 per cent can be expected.

Erosion of seabed material may occur if a critical current velocity, induced by a local water pressure gradient, is exceeded at the boundary between filter and subsoil material. This criterion is expressed in the classic filter rules (see Section 5.4.3.6). A construction designed according to these filter rules is also stable under non-stationary (cyclic) flow. Further, scour of the original sea bed next to the gravel structure will be induced by increased turbulence. The most important governing parameters are the slope steepness of the structure, the ratio between the amplitude of the water displacement and the construction width, and the amount of sediment in suspension. To minimise the amount of erosion that will occur, it is common practice to limit the slope of the gravel bund to a maximum of 1:2.5.

1

2

3

4

5

6

7

8

9

10

6.4.4 Structural considerations

6.4.4.1 Stability against impacts of dropped objects

In the near vicinity of offshore platforms, semi-submersibles or other places where loads are handled above the water surface, there is always a chance of an object being dropped by accident. Dropped objects such as drilling equipment, containers, but also anchors may cause serious damage to pipelines, electrical and optical cables laid down on the sea bed.

Protection of these lines is therefore required. Because trenching in the near vicinity of a platform is mostly not possible or allowed or is more expensive, protection is usually executed by means of rock placement.

The necessary protection, ie the thickness of the armourstone layer, can be assessed by first determining the generated impact energy of the falling object (see Equation 6.2) and the energy absorption capacity of the protection. The kinetic (impact) energy, E_k (Nm), is equal to:

$$E_k = \frac{1}{2} M v^2 \quad (6.2)$$

where M is the mass (kg) and v is the velocity of the object (m/s).

In most cases the falling objects will reach a constant velocity, called the equilibrium velocity V_e (m/s), which is determined by Equation 6.3:

$$V_e = \sqrt{\frac{2}{C_D}} \cdot \sqrt{g \Delta \frac{\Omega}{A_S}} \quad (6.3)$$

or, when the object can be described with an equivalent size, D (m), by:

$$V_e = \sqrt{\frac{4}{3C_D}} \cdot \sqrt{g \Delta D} \quad (6.4)$$

where:

- Δ = relative buoyant density of the object (-)
- Ω = volume of the object (m³)
- A_S = projected cross-sectional area normal to the object's fall velocity (m²)
- C_D = drag coefficient (-); C_D is a function of the Reynolds number and the shape of the object.

An example of the kinetic energy and frequency of occurrence for various types of objects dropped overboard from fixed UK platforms has been recorded in the Veritec Worldwide Offshore Accident Databank. This data showed that in the period 1980–1986 there were 81 crane accidents involving dropped loads, of which 22 were loads dropped overboard. In Table 6.5 the generated impact energy has been given for the objects falling overboard, based on the assumption that the equilibrium fall velocity was reached.

Table 6.5 Frequency of dropped objects with regard to mass (accidents per 100 crane-years)

Dropped objects	Mass (t)	On deck (frequency)	Overboard (frequency)	Impact energy (kNm)
Cargo up to 1 t	1	1.15	0.43	12–260
Cargo container up to 5 t	5	2.03	0.76	62–1320
Crane-block	0.5	0.26	0.10	130
Crane test mass	55	0.26	0.10	2750–15 000
Crane boom fall	10	0.53	0.20	20
Drill collar/casing	3	0.97	0.36	170–740
Bundle of pipes/casings	7.5	0.88	0.33	180
Hydrill/preventer	5	0.26	0.10	640
Riser/conductor section	10	0.18	0.07	2640
Mud pump	32	0.09	0.03	800
Well slot cover plate	4	0.18	0.07	50
Winch	25	0.09	0.03	450–5000
Cable drum	16	0.09	0.03	2800
Diving bell	3	0.09	0.03	30
Life raft	1	0.09	0.03	0
Total		7.15	2.67	
Percentage of total		73	27	

As the total number of crane-years behind these accidents is known (825), it is possible to calculate the accident frequency per 100 crane-years. Based on the data used for Table 6.5, a distribution of the registered impact energies for the objects falling overboard can be given (in total 2.67 crane incidents per 100 crane-years), Figure 6.84.

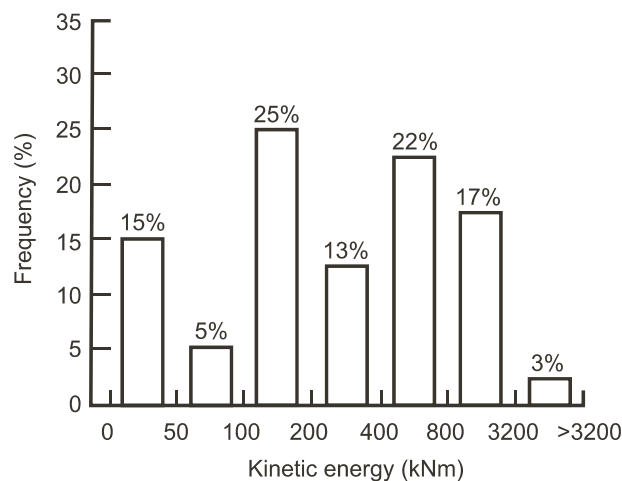
**Figure 6.84** Kinetic energy of falling objects (in classes) just before impact (kNm)

The frequency of incidents (number of occurrences per period of time) with which a pipeline or cable will be hit, is then derived from the product of the probability that a dropped object will hit the pipeline or cable and the frequency of incidents with dropped loads. Based upon a permissible probability of failure, the required exceedance probability of the design impact energy can be determined and hence the required energy-absorbance capacity of the pipeline protection. This analysis can be made for other locations if similar information can be obtained.

Little is known about results of research into the mechanics of impacts on loosely packed material. As a first method of approach the system of rock cover and falling object is modelled as an ideal spring impact model, thereby neglecting viscosity and damping effects. The impact energy absorbance capacity E_c (kJ/m), defined as the energy that is absorbed by the armourstone cover before the dropped object is physically touching the pipeline or cable, can be written as:

$$E_c = \int_0^p R \, dz \quad (6.5)$$

where p is the total penetration depth (m), and R is the resistance of the rock material (kJ/m) as function of the depth, z (m), and the shape of the falling object.

If the velocity vector of the object during impact is orientated vertically, the resistance can, for example, be described by the Terzaghi equation for the maximum bearing capacity (Lambe and Whitman, 1969).

Calculations based upon the above-described theory show that a 1 m gravel layer offers protection against spherical falling objects with an impact energy up to 300 kJ/m.

In Heuzé (1990) an overview is given of experimental and analytical results of projectile penetration into geological materials, with the emphasis on rock targets. Comparison of several calculation methods and test data showed that the predictions for the rate of penetration can vary significantly from one method to the other. It also showed that the applied frictional force is a very uncertain but important aspect of the penetration process. Further, at velocities of up to a few hundred metres per second (!) penetration is most dependent on shear strength and the penetration depth for dumped armourstone appears to scale linearly with the ratio of the penetrator's mass to its cross-sectional area.

To gain a better understanding of the behaviour of impacts into loosely packed protection layers under water further testing and research will be necessary.

6.4.4.2 **Stability of rock berm against dragging anchors**

A traditional anchor is constructed to dig itself into the seabed by its flukes when the anchor chain is pulled. A wide variety of anchors is available. Distinction should be made between:

- standard ship anchors
- work anchors with high holding power (HHP anchor).

The main differences between these two types are the holding power and the burial depth. The HHP anchor is defined as being able to have three times the maximum holding power capacity, with the same anchor mass, of a standard anchor. The holding power is greatly dependent on the soil characteristics, the fluke area and the burial depth. The burial depth depends strongly upon the fluke shank angle and the soil type and may go up to 10 m in soft soils. Literature studies on the behaviour of anchors have been performed by Koster (1974) and Visscher (1980).

For anchors used on merchant vessels the required holding power is lower and the burial depth is therefore smaller. The majority of the world cargo fleet is equipped with anchors that do not penetrate into the sea bed more than 2.5 m.

From this data it is apparent that pipelines and cables cannot be protected against dragging anchors by trenching alone. However, when the probability of an anchor being dropped near a pipeline or cable is acceptably low, protective measures against anchor damage can be omitted.

In some locations this probability can be much higher. In areas of frequent activity by construction barges, supply vessels etc, for example around exploration/production platforms, or in areas with heavy shipping it might be advisable to protect cables and pipelines by a cover of suitable selected armourstone.

Depending on the layout of the rock structure, two mechanisms can lead to breaking out of an anchor.

- 1 A rock protection lying on the original sea bed causes a change in the angle of the anchor chain, resulting in a vertical uplifting force (Figure 6.85).
- 2 A rock protection lying in a trench causes instability of the anchor due to uneven loads on the anchor flukes.

Normally a combination of these mechanisms will determine the behaviour of the anchor when approaching and/or penetrating into the rock protection.

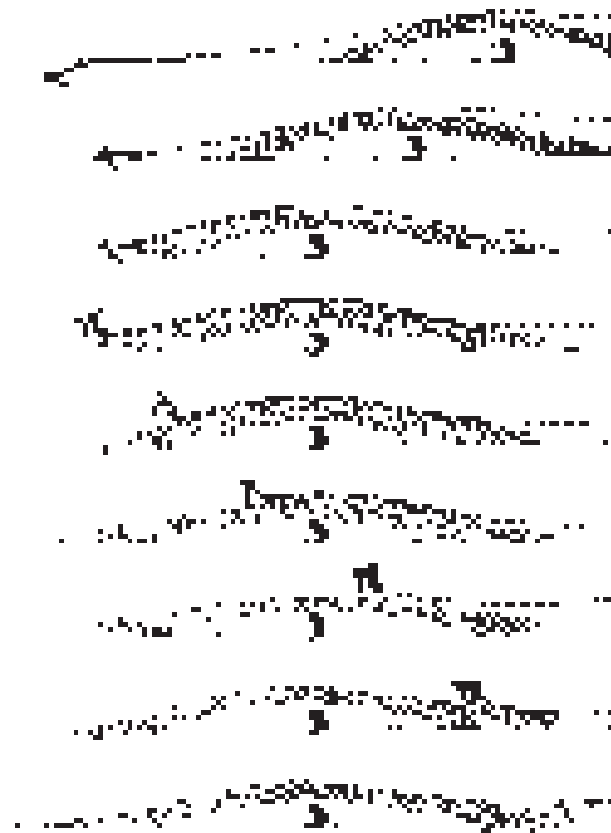

Figure 6.85 Anchor on rock protection lying on sea bed

In the past some model and prototype tests have been performed (Schäle, 1962; Boedt, 1981; Seymour *et al*, 1984) to establish minimum requirements with respect to rockfill protection structures. From those tests it was confirmed that a rock berm initiates an outbalancing force on the anchor and the anchor chain that will eventually result in the breakout of the dragging anchor. The behaviour of the anchor in the presence of a rock berm is governed by the following factors:

- anchor type
- soil characteristics
- original penetration depth of the anchor
- height and width of the rock berm
- type of stone used for construction of the rock berm.

The depth of penetration of the anchor influences the distance required to bring the anchor up to the seabed. With a higher rock berm, the anchor chain direction will be influenced at an earlier point, which will reduce the required width of the berm. Whereas the behaviour of an anchor dragged through a soil layer (Figure 6.85, uppermost panel) can be predicted to a reasonable degree, its behaviour when penetrating through the rock berm and crawling over the crest is more complex. The anchor has to be destabilised as a result of uneven loading of the flukes. The required uneven loading of the flukes will only occur if the stones of the armour layer are sufficiently large in comparison with the length of the flukes (fine gravel will not produce this effect). This results in a certain minimum stone size for the armour layer. The destabilising process of the anchor also requires a certain length of protection to be guaranteed. This required length results in a minimum design width of the rock berm. Most of the knowledge on this topic is based on the results of a number of physical model tests.

6.4.4.3 **Stability of rock berm against fishing gear (trawling)**

Fishing gear from otter trawls (trawl doors) and beam trawlers (beam and trawl shoes) can cause serious damage to pipelines and cables on the sea bottom (ICES, 1980). Freespan sections of the pipeline or cable are at particularly high risk as the lines are likely to be hooked by fishing gear. In extreme cases the fishing vessel may even be pulled down. A sound solution to protect cables or pipelines against fishing gear is a rockfill cover. This cover layer should be able to withstand the horizontal impact loads. The impact load depends mainly on:

- shape and mass of trawl board
- trawling speed
- direction of pull
- seabed conditions
- protection of cable or pipeline.

The average total mass of a trawl door is about 0.5 t to 2 t, the trawl speed is usually between 3 and 5 knots. This corresponds with an impact energy of $E_k = 0.5 \text{ kNm}$ to 6 kNm (see Equation 6.2).

A gently sloping gravel structure will deflect the trawlboard so that only part of this energy has to be absorbed by the stone profile. The penetration into the stone profile is negligible with these relatively small impact energies. A stone cover of 0.5 m is generally sufficient.

6.4.4.4 **Pipeline stability against upheaval buckling**

Hydrocarbons produced from marginal offshore fields are usually transported at high pressure and high temperatures. The compressive stresses induced in the pipeline due to thermal expansion and internal pressure can lead to upheaval buckling. Resistance to upheaval buckling is normally provided by soil, gravel or stone cover offering enough vertical and horizontal support.

Several observed buckling cases that were caused by inadequate backfill cover have forced oil companies to reconsider the problem of upheaval buckling more thoroughly. This section provides an introduction to the buckling problem.

Theoretical modelling

Various authors have addressed the pipeline problem. Historically, the upheaval phenomenon has been considered to be analogous to the vertical stability of railway tracks under solar heating. In Hobbs (1984), Boer *et al* (1986) and Richards *et al* (1986), this analysis procedure for track buckling is used, assuming that the uplift resistance, which is composed

of the mass of the pipe and the mass of the cover, is constant and that the foundation of the pipeline is rigid.

Pedersen and Michelsen (1988) described a mathematical model that includes the non-linear behaviour of the pipe material, the non-linear pipe-soil interaction and the geometric non-linearities caused by large deflections. Consistent with this model, a simplified approach applicable for a pipe in the pre-buckling stage is presented (Pedersen and Jensen, 1988). In this reference the effects of time-varying temperature loadings and non-linear pipe-soil interactions are studied in more detail. It is concluded that the classical upheaval buckling analysis as described above is not conservative for imperfect pipelines. Therefore, a new design procedure is proposed by Nielsen *et al* (1988), based on limiting the uplift movement of the imperfect pipe to the elastic deformation of the cover. This design procedure in combination with the mathematical model, as presented in Pedersen and Michelsen (1988) and Pedersen and Jensen (1988), can be used to determine the required uplift resistance.

An important parameter in the analysis of upheaval buckling is the axial compressive force, N_0 , given by Equation 6.6. At the sub-sea well-head and production platform the pipeline is usually provided with expansion loops, which result in zero axial load. Along the pipeline, surface friction forces between pipeline and subsoil and cover are mobilised until the axial load reaches a level at which the pipeline is completely restrained (Figure 6.86). The completely restrained axial compressive force, N_0 (N), at a distance x is:

$$N_0(x) = \alpha E A_S \delta T(x) - \frac{\pi}{2} \nu_P D_p^2 \delta p \quad (6.6)$$

where:

- α = coefficient of thermal expansion ($1/^\circ\text{C}$)
- E = Young's modulus (N/m^2), see Section 5.4.4.6
- A_S = the cross-sectional area of the (steel) pipe wall (m^2), $A_S = \pi D_p t$
- t = wall thickness (m)
- δT = the temperature change per unit length ($^\circ\text{C}$)
- ν_P = Poisson's ratio (-)
- D_p = the pipe diameter (m)
- δp = difference between internal and external pressure per unit length (N/m^2).

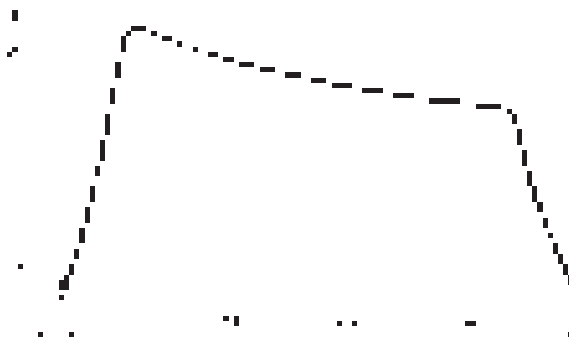

Figure 6.86 Axial compressive force along pipeline

Due to heat loss, the temperature and consequently the axial compressive force will normally vary along the pipeline (Figures 6.86 and 6.87). The heat loss of buried or covered pipelines is greatly influenced by the thermal properties of the cover material and surrounding soil.

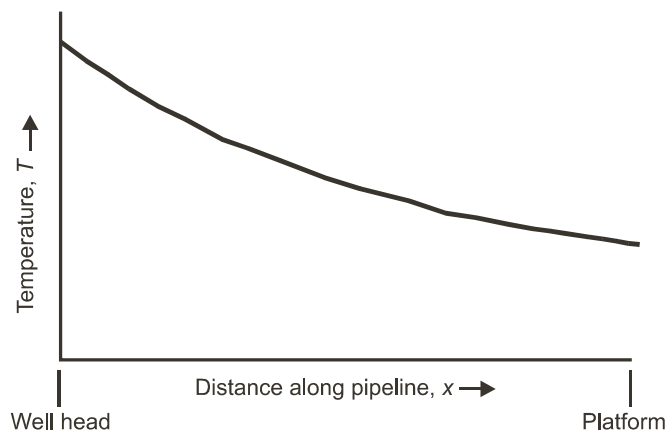

Figure 6.87 Temperature profile along pipeline

Where the cover consists of fine to medium sand or gravel an indication of the heat loss and the resulting temperature drop of submarine pipelines can be obtained by determination of the conductive movement of heat through the granular material. Where the cover consists of high-porosity media such as loosely packed coarse gravel or armourstone, however, the convective movement of heat is also important. Conventional heat loss models, based on conduction only, generally underestimate the heat loss for such situations. Boer and Hulsbergen (1989) described a numerical model that can be used to compute the heat loss and resulting temperature drop of buried and covered pipelines.

Depending on the local axial load, the required resistance against upheaval buckling can be determined. Only the vertical break-out force has to be considered to determine the locally required cover height, as the friction force between pipeline and the soil/cover hardly influences the response in the pre-upheaval buckling stage. To give a detailed description of the buckling model is beyond the scope of this manual. However, full details of the model can be found in Pedersen and Michelsen (1988).

Empirical input

It will be clear that quantitative information about the axial friction and uplift resistance of the cover is essential for practical analysis of submarine pipelines under substantial temperature changes.

The pull-out mechanism of an infinitely long, shallow horizontal pipeline with diameter D_p (m) and a cover layer with a submerged density $\rho' = \rho - \rho_w$ (kg/m^3) and height, t_c (m), is illustrated in Figure 6.88. The maximum resistance force or minimum force for pull-out, P (N/m), is usually written as:

$$P = \rho' g D_p t_c (1 + f t_c / D_p) \quad (6.7)$$

where:

- ρ' = $\rho - \rho_w$ (kg/m^3)
- ρ = mass density of placed stones in saturated condition (kg/m^3), $\rho = \rho_b + n_v \rho_w$
- ρ_b = bulk or as-placed density of the material (kg/m^3), see Section 3.5.1
- ρ_w = density of water (kg/m^3)
- n_v = porosity of the cover (layer) material (-)
- D_p = pipeline diameter (m)
- t_c = cover layer thickness (m)
- f = geotechnical/geometry factor (-).

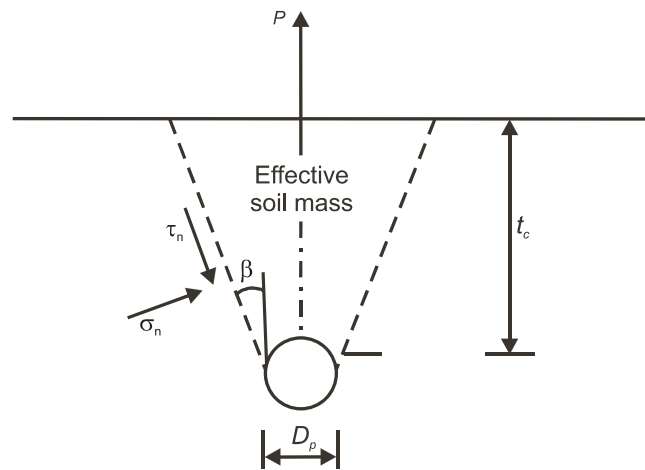

Figure 6.88 Pull-out mechanism of shallow pipe

In this simple empirical formula, f represents a factor for specific geometrical and geotechnical characteristics. Geotechnical literature on pull-out forces mainly refers to horizontal anchor plates in fine granular soils with a horizontal upper boundary. Therefore, it can not be applied directly to a pipeline covered with rock or gravel. This limitation and the lack of verified methods to calculate pipeline pull-out force were important reasons to carry out full-scale pipeline pull-out tests (Boer *et al*, 1986; Schuurmans *et al*, 1989). The test results indicate that the friction factor, f , varies between 0.6 and 1.0. For identical cover properties and embankment geometry, only a small tendency for decrease in f with increasing values of the relative cover thickness (t_c/D_p) has been found.

In view of the buckling problem, the temperature in the pipeline should be as low as possible. On the other hand, the temperature should not drop below a certain minimum level if oil handling problems, such as waxing and decrease of viscosity are likely to occur. In an integrated approach, the pipeline cover and coating can be utilised to optimise the temperature profile along the pipeline.

6.4.4.5 Stability of freespans

Rapid morphological changes of the sea bed, for example large sand and mud waves, can result in partial exposure of an originally buried pipeline or creation of large freespans. Spanning of a pipe can cause the following problems:

- overstressing of the pipe due to its unsupported mass over the length of the freespan and, more seriously
- vibration of the pipe due to oscillating wave velocities, introducing fatigue problems
- the line is now undefended against dragging anchors and fishing gear.

Among other technical solutions, eg (re)trenching of the pipeline or placing of (block) mattresses or geotubes over the pipeline, a well-designed rock protection placed over the pipeline can prevent the formation of freespans. The dimensions of the rock structure have to be designed in such a way that the structure is large enough to follow the changing adjacent sea bed without disintegrating and are therefore dependent on local conditions.

6.4.4.6 Scour protection for slender structures (eg monopiles)

For structures with a relatively small horizontal dimension compared with the water depth, such as monopiles for wind turbines, two basic design principles can be considered (see Figure 6.89).

1. A filter and armour layer placed on the sea bed around the structure. The filter layer is installed before placement of the structure (monopile). After the monopile has been installed the armour layer is placed on top of the filter layer.

2. Installation of the monopile in an unprotected sea bed. A scour hole will develop around the monopile. After the hole has reached the equilibrium depth it will be (partially) filled with filter material and possibly a covering armour layer.

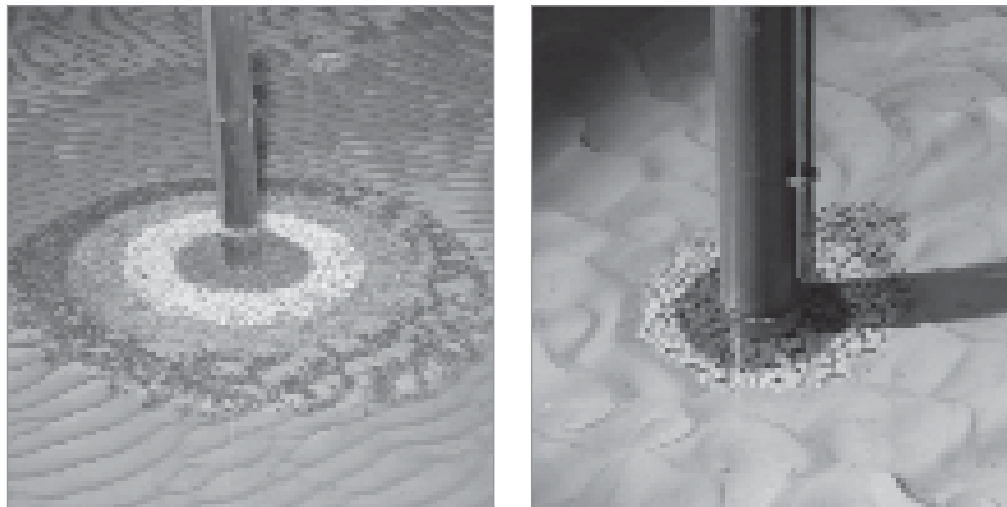

(a) Scour protection on top of sea bed

(b) Protection placed in pre-formed scour hole

Figure 6.89 Scour protection for (a) design principle 1 and (b) design principle 2 (photographs from scale model tests, courtesy E-Connection, <www.e-connection.nl>, Den Boon et al, 2004)

An important factor in the design of offshore wind farms is the resonance behaviour of the monopiles. This behaviour is (partly) dependent on the design of the scour protection. Important aspects are the length of the monopile in the sea bed and the height of the rockfill along the pile.

For the design of the armour grading the combined shear stresses from currents and waves need to be established. The effect of the acceleration induced by the monopile should also be taken into account.

Design Principle 1: Scour protection on top of sea bed

The first principle is to initially place the filter layer of the scour protection. The monopile is then driven through this layer and afterwards the armour layer is installed. The armourstone grading of the top layer is derived by means of standard stability calculations (see Sections 5.2.2.9 and 5.2.3.3 and the underlying filter layers are determined with standard filter rules (see Sections 5.4.3.6 and 5.2.2.10).

Introducing scour protection on the sea bed creates increased turbulence at the downstream side of the protection. This turbulence can induce scour of sea bed material at the edge of the scour protection. The resulting scour hole will partly undermine the edge of the scour protection. Some of the stones will therefore relocate and stabilise the scour slope. The depth of the scour hole that will form at the edge of the scour protection system, as well as the resulting slope, influences the soil strength near the pile. This resulting strength variation must be used as input in the P - y * curves used to calculate the dynamic response of the turbine foundation. By extending the scour protection farther away from the monopile, the effect of the scour hole is reduced. This interaction is the driving parameter to determine the required horizontal dimension of the scour protection.

* A P - y curve gives the relationship between the load per unit length of pile (N/m) and the lateral deflection of the pile (m).

The maximum depth of the scour hole is defined during a *clear water scour* situation. Clear water scour is defined as the situation when the current- and wave-induced velocities upstream of the scour hole do not result in sediment transport. This implies that the effects of the bed protection generate scour and thus an outflow of sediment at the downstream side of the bed protection, without any incoming sediment from the upstream side. Under these circumstances the largest scour depth will occur. When current velocities or wave action further increase from such a state an upstream inflow of sediment will occur, preventing the scour hole from deepening further. Finally an equilibrium scour depth will be reached.

Design Principle 2: Scour protection in pre-formed scour hole

A second option is to install the monopile in an unprotected sea bed and allow a scour hole to develop to its equilibrium depth. The scour hole can then be filled to a certain extent with crushed rock. Calculation of the stone sizes required for stability is as for Design Principle 1, using the methods presented in Section 5.2.3.

If the top of the armour layer is equal to the original seabed level, then no additional turbulence will be introduced by the presence of the scour protection. However, the seabed roughness will increase to some extent, which may cause some extra turbulence. Here, too, is a chance for erosion to occur at the edge of the scour protection, as described in the previous design principle, but probably now to a smaller extent as the structure is less obtrusive.

6.4.4.7 Scour protection for large structures (CGSs)

This type of structure is characterised by a cross-sectional area or diameter that is large relative to the water depth. Concrete gravity structures (CGSs) are a common example, such as used for offshore platforms. CGSs are usually constructed in fairly deep water (20 m or more) and can be subject to extremely high wave and current attack.

For the scour protection of this type of structure three principally different solutions are possible:

- **conventional design approach:** based on the provision of a hydraulic and geotechnical statically stable scour protection
- **falling apron principle:** erosion is permitted at the extremities of the scour protection, resulting in a reduction of the area covered by the scour protection
- **dynamic design approach:** scour hole development both in and behind the scour protection is permitted while maintaining the primary function of the scour protection, which is to guarantee the geotechnical stability of the structure.

The horizontal extent of the scour protection will depend on the expected size of the scour hole that will form.

Conventional design approach

The conventional approach establishes a hydraulically and geotechnically stable scour protection of sufficient length. The rock grading of the top layer must be stable under the extreme design conditions. This usually results in a heavy rock grading. Beneath the armour layer either one or more filter layers or, alternatively and to reduce the number of layers, a sand-tight geotextile is applied to comply with the filter rules.

Various design formulae exist to determine the armourstone size for a conventional design. However, verification of the design in a physical scale model is strongly recommended and is often a contract requirement. This is because the high costs of repair works and possible environmental consequences arising from failure of the scour protection make it essential to minimise the risk of damage. The complicated 3D nature of the flow around such a structure,

and the interaction with the bed and scour protection, render it impossible to compute the required armourstone size and distribution to a sufficient degree of certainty using current calculation methods. However, a physical model can also be used to achieve cost-saving optimisation of the design. Recently the behaviour of the scour protection at an offshore platform in the Dutch North Sea has been evaluated and compared with that computed using standard design methods and with that measured in a scale model during the design phase. Results showed that the scale model tests agreed well with the survey measurements while the empirical design formulae predicted higher scour depths (Bos *et al.*, 2002).

Falling apron scour protection

A falling apron is an amount of granular material at the toe of a revetment or around a structure. When scour starts to develop the material is redistributed on to the developing slope. When applying the falling apron principle, scour hole development at the edge of the scour protection occurs and causes some of the scour protection to relocate. The protective influence of the relocated stones leads to the formation of gentle scour hole slopes. These slopes are taken into account in the geotechnical stability calculations. This will reduce the extent of the scour protection required.

For some platforms a falling apron design can be applied. An example is shown in Figure 6.90.

The platform considered here was placed in a water depth of 30 m and was subject to significant wave heights up to 10 m and currents of 1.5 m/s under the design condition. The design condition allowed some damage to the scour protection but not to the point that the foundation pad was exposed. The final design of the scour protection was determined from testing in a 1:70-scale model. From the model tests it was found that the volume of the scour protection could be significantly reduced (by 40 per cent) from the initial design.

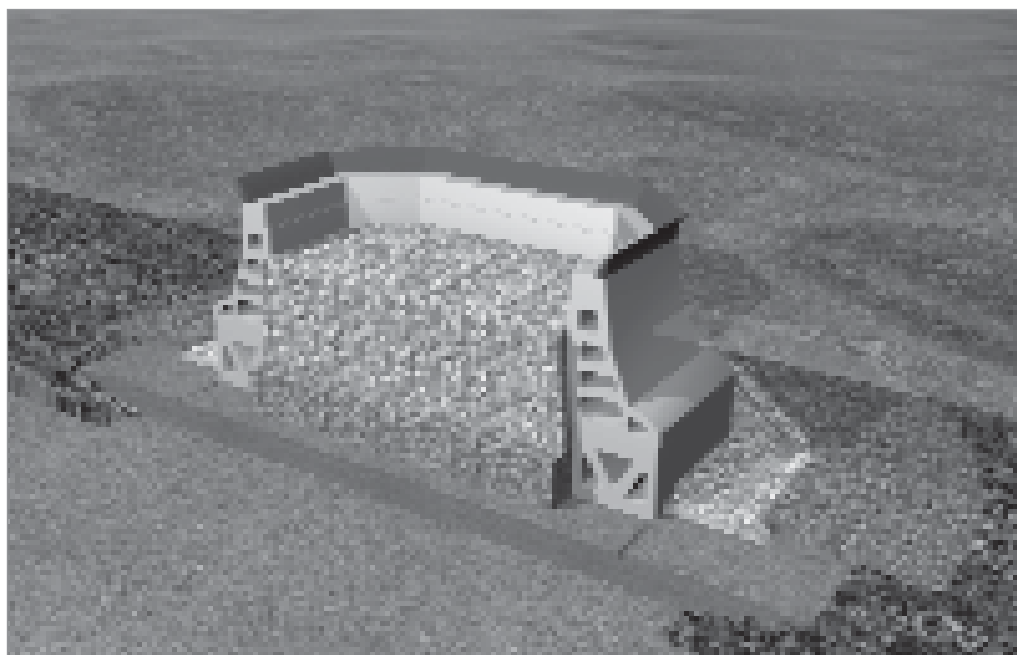

Figure 6.90 Schematic view of platform showing bedding and scour protection layers (courtesy Van Oord)

Because of the special form of the platform the scour protection was required predominantly to provide protection against current acceleration around the corners and sides.

Installation was performed using a flexible fall-pipe (FFP) system (see Section 9.3.5 for a description) with an armourstone grading specified as 60–400 kg. This grading is rather large for an FFP, so great care had to be taken during the dumping process. The model tests indicated that a 1.5 m-thick armour layer on top of a (geometrically closed) filter (see Section 5.4.3.6) of 10–100 mm would be adequate. In front of the armour layer for the platform, a falling apron 8 m wide (4 m along the sides) was designed to control erosion of the scour protection toe (open filter layer with a grading of 60–200 mm). The horizontal extent of the armour layer in the more exposed eastern corners was 9 m, reducing to 6 m in the western corners. Along the sides of the platform the extent of the armour layer was limited to just 3 m.

Dynamically stable scour protection

The application of dynamically scour protection for a CGS is a fairly recent development and has the advantage that a small rock gradation can be used compared to a conventional design. For a **dynamically stable** scour protection the development of limited scour in and/or behind the scour protection is permitted. The main principle is that a large amount of relatively small stones (eg 50–250 mm coarse armourstone grading) is placed around the marine structure. The scour protection is designed in such a way that the maximum expected scour hole in the rock protection is smaller than the total layer thickness. “Dynamically” refers to the fact that scour holes will develop in the scour protection layer; it is “stable” because eventually an equilibrium situation will be reached. The advantages of this scour protection design are that (i) the construction is relatively simple, (ii) quite small diameter armourstone can be used and (iii) maintenance can easily be carried out by additional dumps of stone.

The dynamic scour protection approach has recently been applied at a number of offshore platforms. The design of the scour protection usually consists of a coarse armourstone grading, as stated above. One example of this type of protection consisted of a 1 m-thick layer of small stones with a 50–250 mm grading (maximum stone size of approximately 250 mm) and with an outer slope of 1:3. The CGS was placed in approximately 43 m water depth with a design wave height of $H_{s,d} = 9.7$ m. The maximum joint occurrence near-bed current velocity was estimated as 0.27 m/s. On top of these a safety factor of 1.3 was applied. Numerical computations indicated a maximum amplification at one of the corners of 2.5 times the ambient undisturbed current velocity, which would occur within a narrow zone extending out to about 10 m from the platform. The maximum amplification of the wave-induced flow is approximately three times the ambient flow and would occur approximately 2 m from the corner. The horizontal extent of a dynamically stable scour protection, and thus the total amount of stone, must be large enough to ensure that the armourstone at the edge of the sill is stable. The structure introduces local turbulence generated by the obstruction of the flow. Based on the numerical studies, it was determined that the scour protection extent required was 6 m (perpendicular to the walls) of the CGS within 15 m of the corners (parallel to the walls).

6.4.5 Cost aspects

The construction cost of an offshore rockfill structure can be divided into purchase, transportation and placing of the rockfill material and surveying of the offshore structure. An extra amount should cover the expected inaccuracy of the dumping method (Section 9.3.7). Minimum dumping accuracy is achieved (ie losses are greatest) when using a split-hopper barge, while the greatest accuracy is achieved with a fall-pipe system.

Stone losses will increase with increasing water depth when using the side stone-dumping vessel and split-hopper barge. Therefore, for each type of armourstone dumping the minimum amount of stone required for a specific job can be estimated.

Based on the required stone quantity, for each stone-dumping vessel (with a certain loading capacity, sailing speed, survey facilities etc) the duration and expected costs of the stone-dumping works can be calculated. This is done by assessing the expected number and duration of a dump cycle, which can be separated into loading of the armourstone, sailing to site, system set-up, stone dumping, pre-, intermediate and post-survey, system recovering and sailing back to the quarry or deposit. Workability restrictions caused by wind and wave conditions differ for each vessel and each type of stone dumping (see Section 9.3).

6.4.6 Construction issues that influence design

6.4.6.1 Construction methods

There are at least three methods of offshore stone dumping.

- 1 From a side stone-dumping vessel or barge. The load is dumped slowly and each stone may be considered to fall individually for the purpose of evaluating the fall velocity.
- 2 From a split-hopper barge. After the bottom gap of the barge exceeds a certain limit, the load is dumped in a short time as a single mass. The mass of stones stays together in a *cloud*, resulting in a fall velocity exceeding the equilibrium fall velocity of each individual stone.
- 3 From a vessel through a (flexible) pipe in order to achieve greater accuracy in deeper water.

Construction aspects in are discussed in Chapter 9. In particular, typical types of equipment and working conditions associated with the above methods are addressed in Section 9.3.

6.4.6.2 Impact of dumped stone

From the evaluation of the different construction methods it can be concluded that, if stone is dumped by means of a side stone-dumping vessel or a flexible fall-pipe vessel, the fall velocity of the stones will be limited by the equilibrium velocity. It is essential to ascertain the resistance of the pipeline and cables against the impact of the falling stones.

Full-scale as well as laboratory tests have been performed in the past using stone of $D = 50\text{--}150$ mm to determine possible damage to coatings of steel pipes, flexible flowlines and cables. It was concluded that rock dumping on pipelines, flowlines or cables will not lead to damage for pipelines provided with a coating of more than 1 mm.

As a rule of thumb the impact of a stone with a certain diameter falling in water is comparable to the impact of the same stone falling in air from a height of approximately its own diameter.

Dumping from a side stone-dumping vessel

The loading capacity of side stone-dumping vessels ranges from 500 t to 2000 t. They discharge their loads by pushing the stone gradually over the side of the vessel. For a side stone-dumping vessel of 1000 t the actual dumping time is approximately 15 minutes. Depending on the local water depth, the dimensions of the dumping profile and the dimensions of the stones, the vessel can either keep station or track along or over the pipeline.

Dumping from a split-hopper barge

A split-hopper-type barge can dump its cargo in less than a minute! As a result, a cloud of stones and water will reach the bottom with a velocity of two to three times the equilibrium velocity of an individual falling stone. The impact of the split barge dump is very heavy and may damage a pipeline or cable, particularly freespan sections.

Moreover, the dumped material usually shifts sideways after hitting the bottom, leaving only a relatively small quantity at the desired location. Consequently split-hopper barges are usually not employed for jobs requiring accurate placing of stones, such as the protection or stabilisation of pipelines or cables in deeper water. The area of work of a split-hopper barge is mainly the dumping of large quantities of gravel or armourstone in shallow water (roughly two times the maximum draught of the barge) where accuracy is not a high priority.

Dumping with a flexible fall-pipe (FFP) vessel

This system guides the stones to a level several metres above the sea bed and is therefore especially suitable for accurate dumping in deeper water (up to 1000 m). The system consists of a vessel from which a (flexible) pipe can be lowered down, to a level of several metres above the sea bed. The end of the pipe can be positioned using either an independent working propulsion unit or a free-moving remote-operating vehicle (ROV), both fitted with equipment capable of making surveys. While tracking along the pipeline at a constant speed, the rockfill is placed over the pipe.

Dumping accuracy is dependent only upon the accuracy of the positioning of the lower end of the fall pipe relative to the pipeline. The vertical movement is controlled and restricted by a heave compensating system. A thruster unit enables the operator to control and correct the horizontal displacement.

Section 9.3.5 describes this method in more detail.

6.4.6.3

Survey

To control and document the results of the dumping operations during the various stages of the works, surveys have to be executed. These can either be conducted from the dumping vessel itself or from a separate vessel, possibly equipped with a ROV fitted with multiple sensors. A wide range of survey equipment is available. Usually the following (sub)systems form part of the survey system:

- surface positioning system
- sub-surface positioning system
- gyro compasses
- scanning profilers
- depth sensors
- video systems
- computer systems.

Usually, the onboard navigation computer is the heart of the survey system to which can be interfaced, among others, the surface positioning system(s), the ROV ship positioning system, the vessel gyro compass and the ROV gyro compass and scanning profiler system. The ROV may be fitted with underwater cameras and a scanning profiler system. The ROV ship positioning system provides the ROV position relative to the vessel.

Before starting the survey operations it is usually necessary to perform checks to ensure that the overall system provides data to the required standards. The results of those checks or calibrations have to be recorded to monitor significant changes in value over time.

Three types of survey can be distinguished.

1 Pre-survey

The pre-survey has two main purposes:

- a to establish the exact *as-found* co ordinates of the dump area
- b to establish the pre-dump seabed profile for later assessment of the dumped quantities, dump height and dump dimensions.

A bathymetric survey grid, with pre-established intervals, is covered for this pre-survey. Cross-sectional and/or longitudinal profiles are produced from the logged echosounder data for later comparison with final survey profiles.

2 Intermediate survey

This survey is carried out for appraisal of the dump dimensions.

3 Post-survey

After completion of the dumping a post-survey is executed over the same bathymetric grid area as the pre-survey. The results are compared with the pre-survey data to confirm that the dumped profile is in accordance with the client's specifications. The post-survey techniques are the same as those used for the pre-survey. Preferably cross-sectional and longitudinal profiles are produced at approximately the same locations as the pre-survey.

Specific survey techniques are described further in Section 9.9.

6.5 REFERENCES

- Baird, W F, Caldwell, J M, Edge, B L, Magoon, O T and Treadwell, D D (1981) "Report on the Damages to the Sines Breakwater, Portugal", In: B L Edge (ed), *Proc. 17th int coastal engg conf, Sydney, Australia, 23–28 March 1980*. ASCE, pp 3063-3077
- Barber, P C and Davies, P C (1985). "Offshore breakwaters – Leasowe Bay". In: *Proc Instn Civil Engineers*, vol 77, Institution of Civil Engineers, London
- Beil, N J and Sorensen, R M (1989). "Perched beach profile response to wave action". In: B L Edge (ed), *Proc 21st int conf coastal engg, Malaga, 20–25 Jun 1988*. ASCE, New York, vol 3, pp 1482–1492
- Berenguer, J M and Enriquez, J (1989). "Design of pocket beaches, a Spanish case". In: B L Edge (ed), *Proc 21st int conf coastal engg, Malaga, 20–25 Jun 1988*. ASCE, New York, vol 3, pp 1411–1425
- Boer, S and Hulsbergen, C H (1989). "Thermal aspects of trenching, burial and covering of hot submarine pipelines". In: *Proc conf offshore mechanics and artic engg, The Hague, The Netherlands*
- Boer, S, Hulsbergen, C H, Richards, D M, Klok, A and Biaggi, J P (1986). "Buckling consideration in the design of the gravel cover for a high-temperature oil line". In: *Proc offshore technology conf, Houston*. Paper no OTC 5294
- Boodt, C (1981). "Protection of sinker against anchors", Investigation and testing structures, *Polytechnical Magazine*, no 5
- Bos, K J, Chen, Z, Verheij, H J, Onderwater, M and Visser M (2002). "Local scour and protection of F3 offshore GBS platform". In: *Proc conf offshore mechanics and artic engg (OMAE) 2002, Oslo, Norway*
- Crossman, M, Segura-Dominquez, S and Allsop, N W H (2003). *Low cost structures for beach control and coast protection: practical design guidance*. Defra/EA Technical Report FD 2409, Environment Agency, Bristol and Defra, London
- Dean, R G (1987). "Coastal armouring; effects, principle and mitigation". In: B L Edge (ed), *Proc 20th int conf coastal engg, Taipei, 9–14 Nov 1986*. ASCE, New York, pp 1843–1857
- Dean, R G (1988). "Evaluation of shoreline protection structures (including beach nourishment)". In: *Proc int short course on planning and designing maritime structures, Malaga, Spain*. ASCE, New York
- Den Boon, J H, Sutherland, J, Whitehouse, R, Soulsby, R, Stam, C J M, Verhoeven, K, Hogedal, M, and Hald, T (2004). "Scour behaviour and scour protection for monopile foundations of offshore wind turbines". In: *Proc Euro wind energy conf, London, 22–25 Nov*
- Dossche, M, Elskens, F, and Sas, M (1992). Research of the effect of propeller erosion on quay-walls and comparison of bottom protection schemes. In: *Proc 10th harbour congress, Antwerp*. Royal Society of Flemish Engineers, Antwerp
- EAU (1996). *Recommendations of the committee for waterfront structures, harbours and waterways*, 7th English edition. Ernst & Sohn, Berlin
- Fleming, C A and Hamer, B (2001). "Successful implementation of an offshore breakwater scheme". In: B L Edge (ed) *Proc 27th int coastal engg conf, Sydney, Australia, 16–21 July 2000*. ASCE, pp 1813–1820
- Fleming C A (1990). "Principles and effectiveness of groynes". In: K W Pilarczyk (ed), *Coastal protection*. AA Balkema, Rotterdam
- Gilman, J F (1987). "Performance of a berm roundhead in the St. George breakwater system". In: *Proc berm breakwaters: unconventional rubble-mound breakwaters*. Derived from a workshop at the Hydraulics Laboratory, National Research Council of Canada, Ottawa, Canada, 15–16 Sep, 1987. ASCE, New York
- Goda, Y (2000). *Random seas and design structures*, 2nd edn. University of Tokyo Press, Tokyo

- Heuzé, F H (1990). "An overview of projectile penetration into geological materials, with emphasis on rocks". *Int J Rock Mechanics Min Sci & Geomech Abstr*, vol 27, no 1, pp 1–14
- Hobbs, R E (1984). "In service buckling of heated pipelines". *J Transportation Engineering*, vol 110, no 2, pp 175–189
- Hoffmans, G J C M and Verheij, H J (1997). *Scour manual*. AA Balkema, Rotterdam, p 205
- International Council of the Exploration of the Sea (ICES) (1980). *Interaction between the fishing industry and the offshore gas/oil industries*. Co-operative Research Report no 94, ICES, Copenhagen
- Jensen, O J (1983) "Breakwater Superstructures". In J R Weggel (ed) *Proc conf coastal structures, 9–11 March 1983, Arlington, VA*. ASCE, New York, pp 272–285
- Juhl, J, Alikhani, A, Sloth, P and Archetti, R (1997). "Roundhead stability of berms". In: B L Edge (ed), *Proc 25th int conf coastal engg, Orlando, FL, 2–6 Sep 1996*. ASCE, New York, vol 2
- Koster, J (1974). *Digging in of anchors into the bottom of the North Sea*. Publication no 129, Delft Hydraulics Laboratorium, Delft
- Lambe, T W and Whitman, R V (eds) (1964). *Soil mechanics*. John Wiley, New York
- Menze, A (2000). "Stability of multilayer berm breakwaters". Diploma thesis, University of Braunschweig, Germany
- Miyata, M, Sugano, T, Nagao, T, Nakagawa, M, Mustoe, G G W, Tanaka, T and Kikuchi, N (2003). "Experimental study on load support systems of rubble rock foundations", *J Geotech Eng*, JSCE, no 750, 2003.12, pp 1–14
- Nielsen, N J R, Pedersen, P T, Grundy, A K and Lynberg, B S (1988). "New design criteria for upheaval creep of buried sub-sea pipelines". In: *Proc offshore mech and arctic eng conf, Houston*. Paper no OMAE-88-861
- Oumeraci, H, Kortenhaus, A, Allsop, N W H, De Groot, M B, Crouch, R S, Vrijling, J K and Voortman, H G (2001). *Probabilistic design tools for vertical breakwaters*. AA Balkema, Rotterdam, 373 pp (ISBN 90-5809-248-8)
- Palmer, G W and Christian, C D (1998). "Design and construction of rubble-mound breakwaters". *IPENZ Transaction*, vol 25, no 1/CE
- Pedersen, P T and Jepsens J J (1988). "Upheaval creep of buried heated pipelines with initial imperfections". *Marine Structures, Design, Construction, Safety*, vol 1, pp 11–22
- Pedersen, P T and Michelsen, J (1988). "Large deflection upheaval buckling of marine pipelines". In: *Proc BOSS conf, Stavanger*, pp 965–80
- PIANC (2003). *State-of-the-art of designing and constructing berm breakwaters*. Report of MarCom WG40, PIANC, Brussels
- PIANC (1997). *Guidelines for the design of armoured slopes under open piled quay walls*. Report of MarCom WG22, PIANC, Brussels
- PIANC (1987). *Guidelines for the design and construction of flexible revetments incorporating geotextiles for inland waterways*. Report of InCom WG04, PIANC, Brussels
- Pilarczyk, K W (ed) (1998). *Dikes and revetments: design, maintenance and safety assessment*. AA Balkema, Rotterdam
- Pilarczyk, K W (1990). "Design of seawalls and dikes, including overview of revetments". In: K W Pilarczyk (ed), *Coastal protection*. AA Balkema, Rotterdam
- Richards, D M and Andronicou, A (1986). "Seabed irregularity effects on the buckling of heated submarine pipelines". In: *Proc Holland Offshore 86, Advance in Offshore Technology, Amsterdam*
- Rotterdam Public Works Engineering Department, Port of Rotterdam, VBKO and IADC (2001). *Construction and survey accuracies for the execution of dredging and stone dumping works*. Rotterdam

- Schäle, E (1962). *Anchoring tests for the revetment of navigation canals* (in German). Duisberg
- Schiereck, G J (2001). *Introduction to bed, bank and shore protection*. Delft University Press, Delft
- Schuurmans, S T, Boer, S and Lindenberg, J (1989). *Hot pipelines, a hot issue; Pipeline-pipecover interaction related to upheaval buckling*. Offshore Pipeline Technology Seminar (OPT), Amsterdam
- Seymour, E V, Craze, D J and Ruinen, W (1984). "Design and installation of the North Rankin trunkline and slugcatcher". In: *Proc 5th offshore South East Asia conf, Singapore*
- Sigurdarson, S, Smarason O B and Viggosson G (2005). "Berm breakwaters". In: P Bruun (ed), *Port and coastal engineering – developments in science and technology. J Coastal Research*, special issue no 46, Coastal Education and Research Foundation Inc
- Sigurdarson, S, Jacobsen, A, Smarason, O, Bjørdal, S, Viggosson, G, Urrang, C and Tørum, A (2004). "Sirevåg berm breakwater. Design, construction and experience after design storm". In: J A Melby (ed), *Proc 4th int coastal structures conf, Portland, OR, 26–30 Aug 2003*. ASCE, Reston, VA
- Simm, J D, Brampton, A H, Beech, N W *et al* (1996). *Beach management manual*. Report 153, CIRIA, London
- Tanimoto, K, Yagyu, T, and Goda, Y (1983). "Irregular wave tests for composite breakwater foundations". In: B L Edge (ed), *Proc 18th int conf coastal engg, Cape Town, 14–19 Nov 1982*. ASCE, New York
- Thoresen, C A (2003). *Port designer's handbook: recommendations and guidelines*. Thomas Telford, London
- Toti M, Cucciollatte, P and Ferrante, A (1990). "Beach nourishment at Lido Di Ostia". In: *Proc 27th int nav congr, Osaka, 20–26 May*
- Tørum, A, Kuhnen, F and Menze, A (2003a). "On berm breakwaters. Stability, scour, overtopping". *Coastal engineering*, vol 49, pp 209–238
- Tørum, A, Bjørdal, S, Mathiesen, M, Arntsen, Ø A, Jacobsen, A (2003b). "Berm breakwaters. Comparison between model scale and prototype stability behaviour". In: *Proc 17th int conf port and ocean engg under arctic conditions, POAC '03, Trondheim, 16–19 Jun*. Trondheim
- Tørum, A, Bjørdal, S, Mathiesen, M and Arntsen, Ø A (2003c). *The Sirevåg berm breakwater. Comparison between physical model and prototype behaviour*. Report no IBAT/MB R1, Norwegian University of Science and Technology, Department of Civil and Transport Engineering, Trondheim
- Tørum, A (1999). "On the stability of berm breakwaters in shallow and deep waters". In: B L Edge (ed), *Proc 26th int conf coastal engg, Copenhagen, 22–26 Jun 1998*. ASCE, Reston, VA, pp 1884–1897
- Tørum, A (1997). *Berm breakwaters. EC MAST II Berm breakwater structures*. STF22 A97205, SINTEF, Trondheim
- Visscher, J T (1980). *Burial depth of ships and work anchors* (in Dutch). MaTS PL-2, Part V, Netherlands Industrial Council for Oceanology
- Vrijling, J K and Nooy van der Kolff, A H (1990). "Quarry yield and breakwater demand". In: *Proc 6th cong Int Assoc Engg Geol, Amsterdam, 6–10 Aug*. AA Balkema, Rotterdam, vol 4, pp 2927–2934
- Westeren, K (1995). "Bølgekrefter på dekkstein på skuldermoloer" ("Wave forces on armour units on berm breakwaters"). MSc thesis, Norwegian University of Science and Technology, Department of Structural Engineering, Trondheim. Briefly summarised in Tørum (1997)
- Whitehouse, R J S (1998). *Scour at marine structures*. Thomas Telford Ltd, London

