

## **The Rock Manual 2007 (c683) – digital version**

The digital version of the Rock Manual is available on CD with the printed book. It can also be downloaded from the CIRIA website.

To avoid illegal copyright, the resolution of the Figures on the PDF is low. However a number of the Figures have become unreadable, especially in Chapter 5. This PDF document contains better quality Figures ; only those Figures which are unreadable are copied in this document.

Figures of Chapter 2:

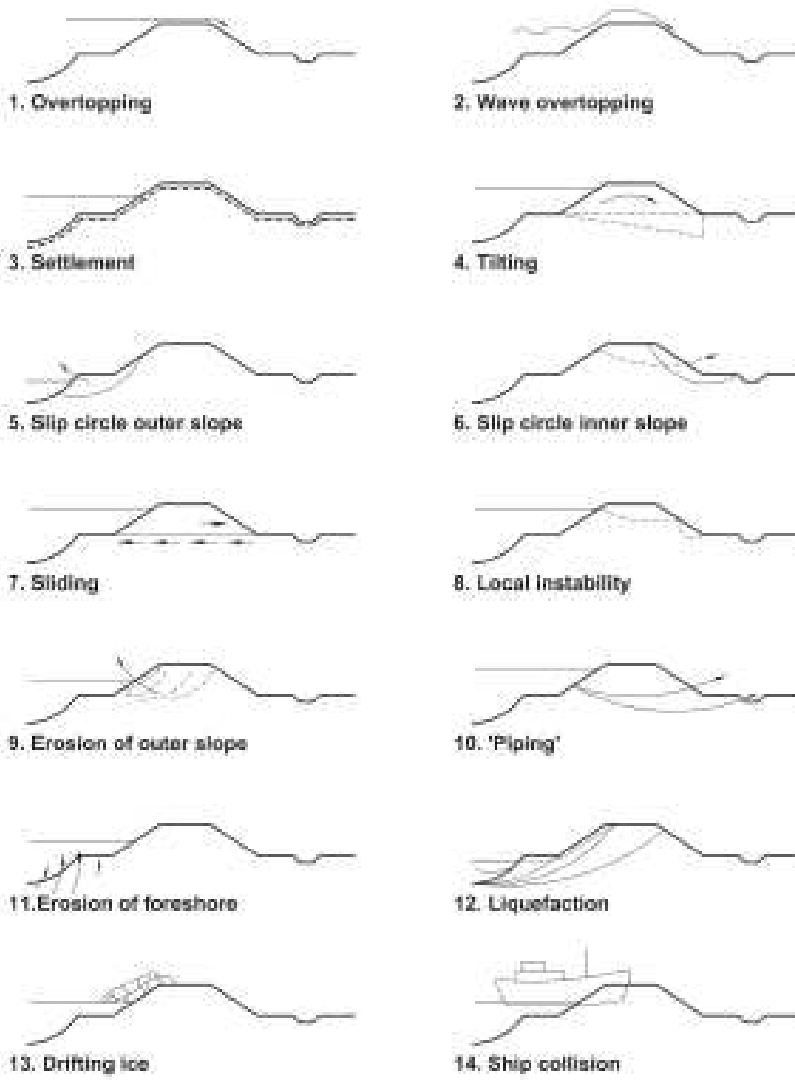

Figure 2.3

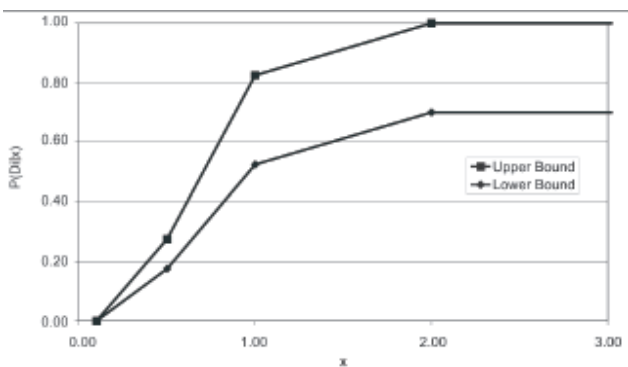

Figure 2.6

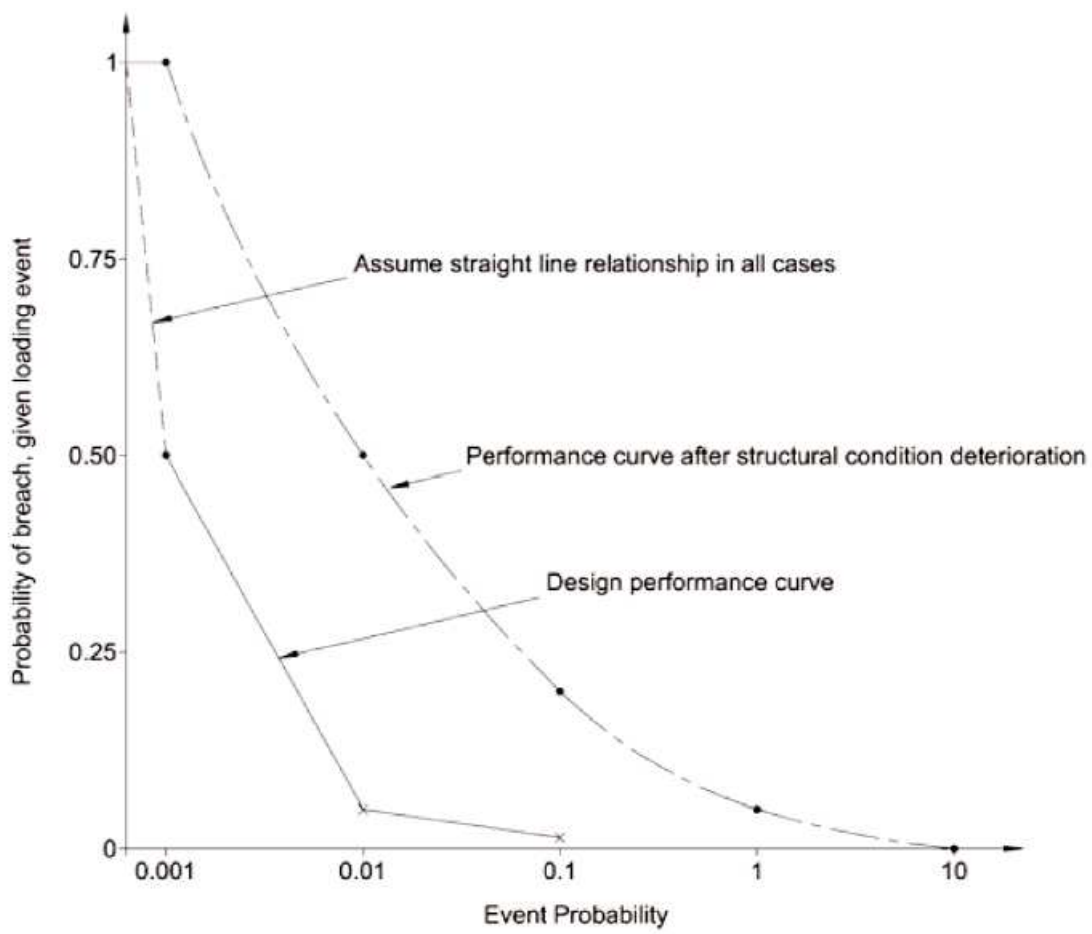

Figure 2.7

Figures of Chapter 3:

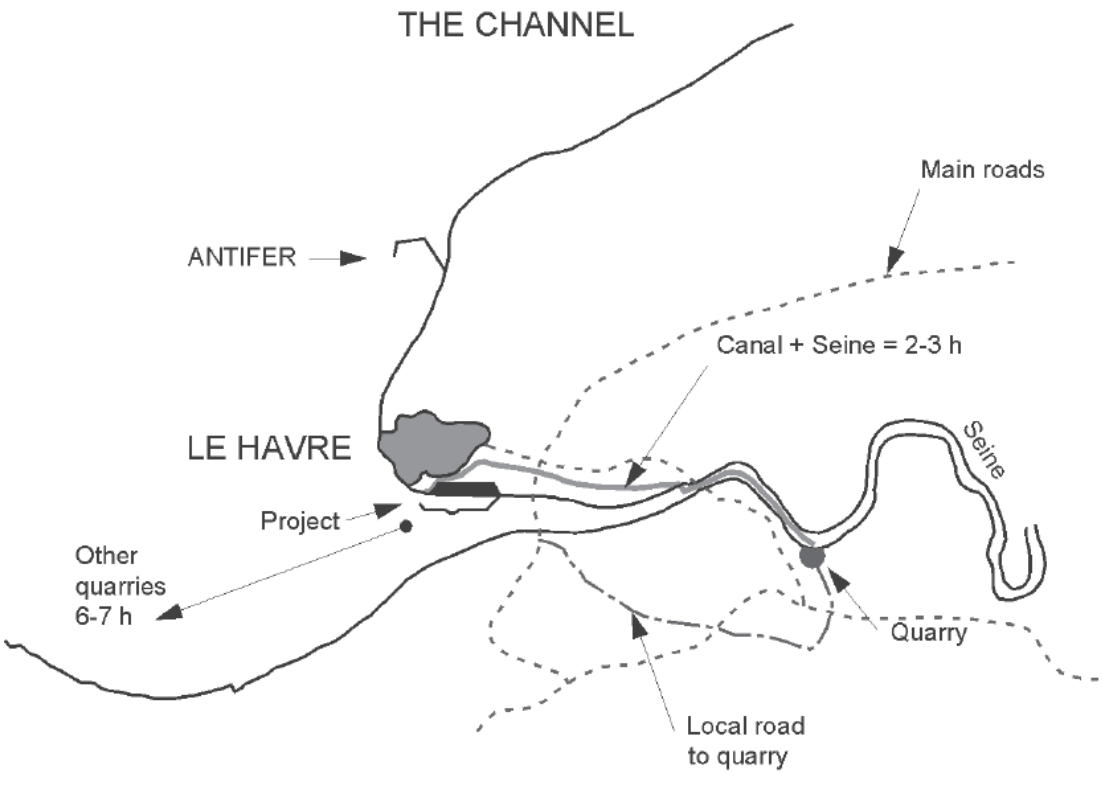

Figure 3.6

Figures of Chapter 4:

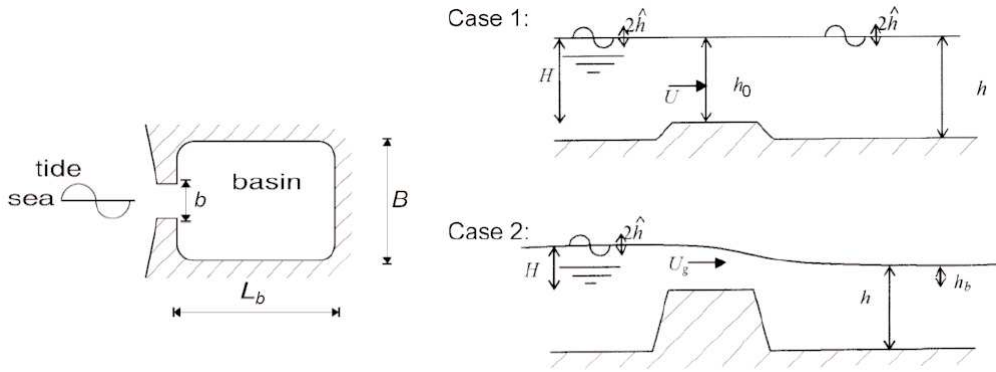

Figure 4.18

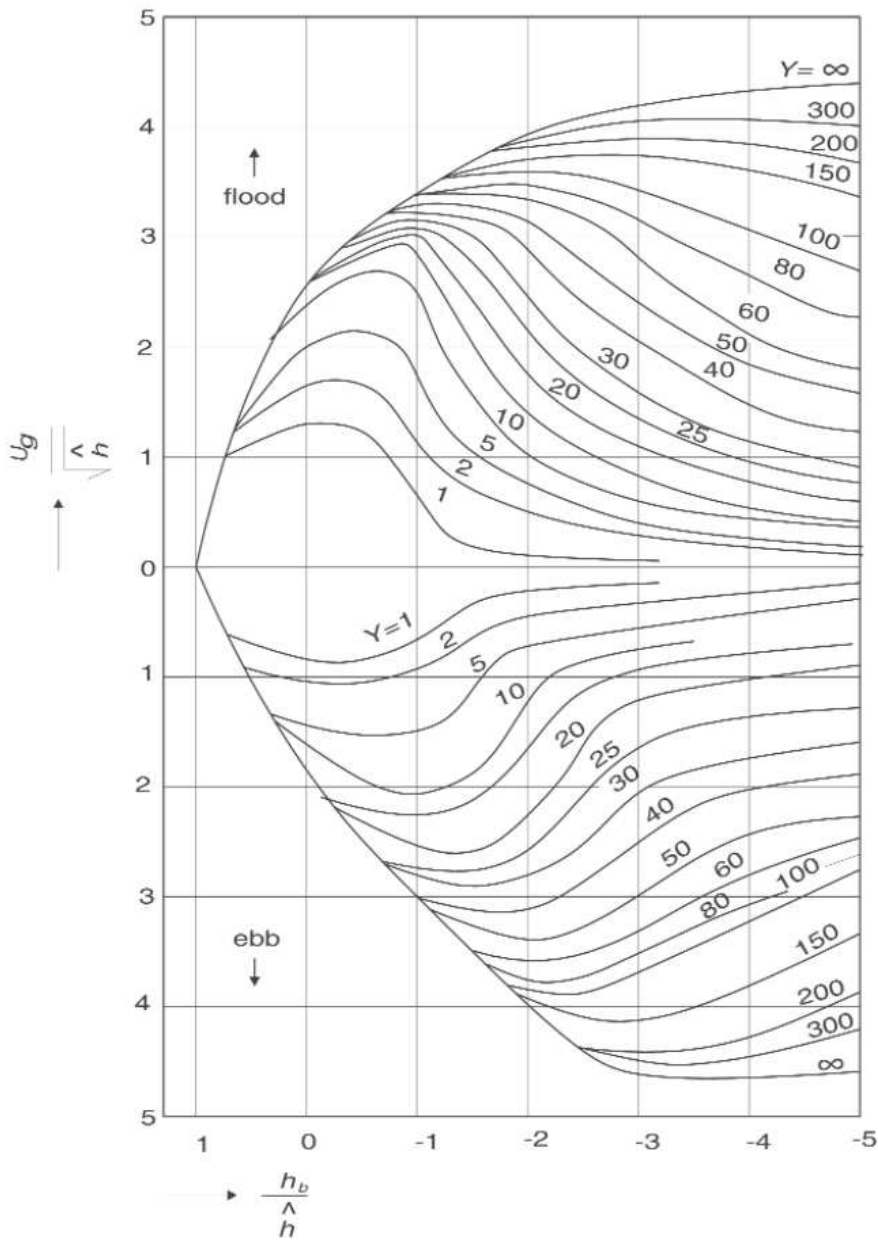

Figure 4.19

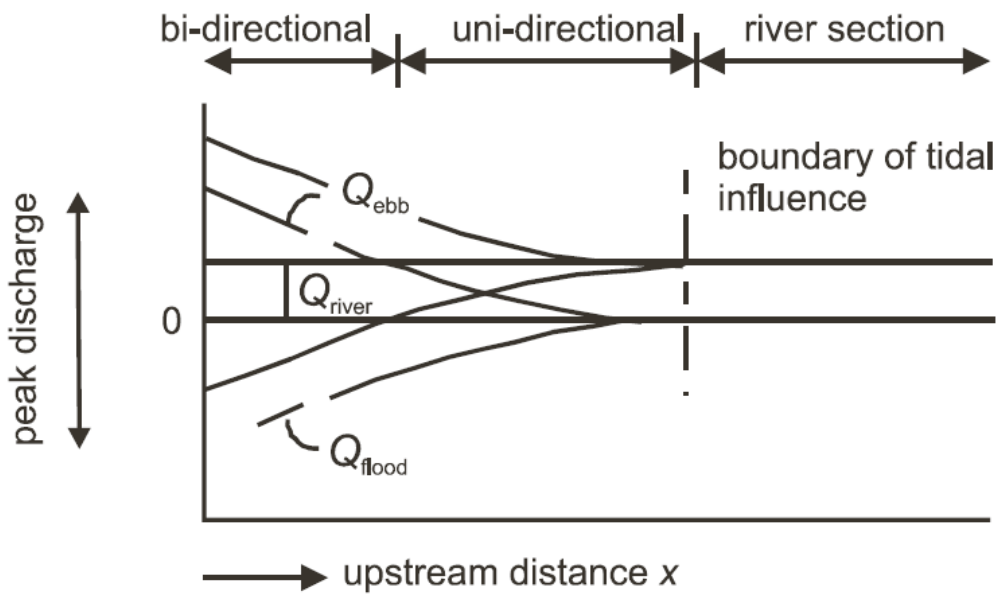

Figure 4.20

Figures from Chapter 5:

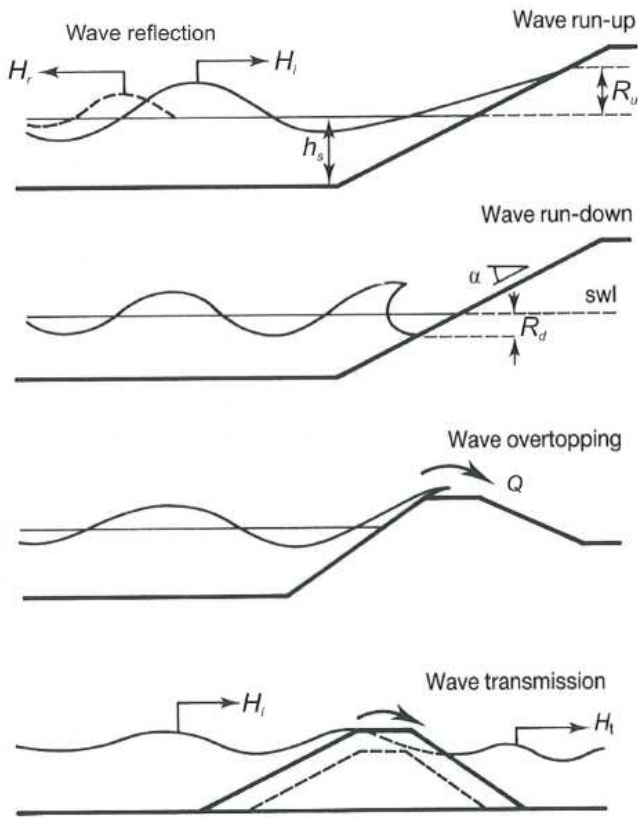

Figure 5.2

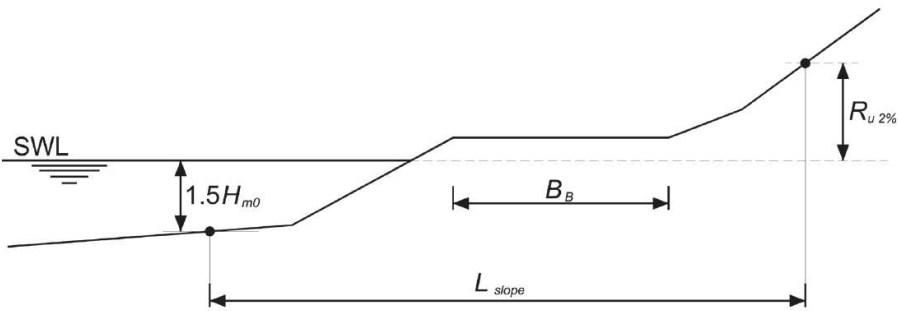

Figure 5.6

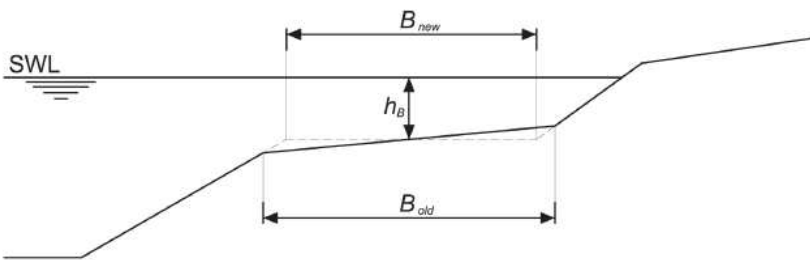

Figure 5.7

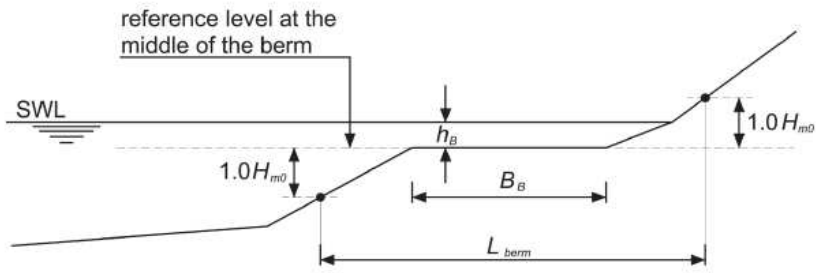

Figure 5.8

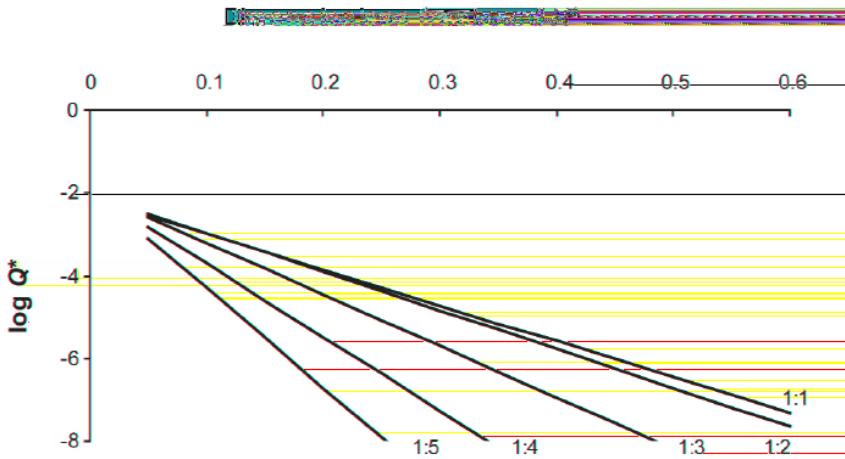

Figure 5.10

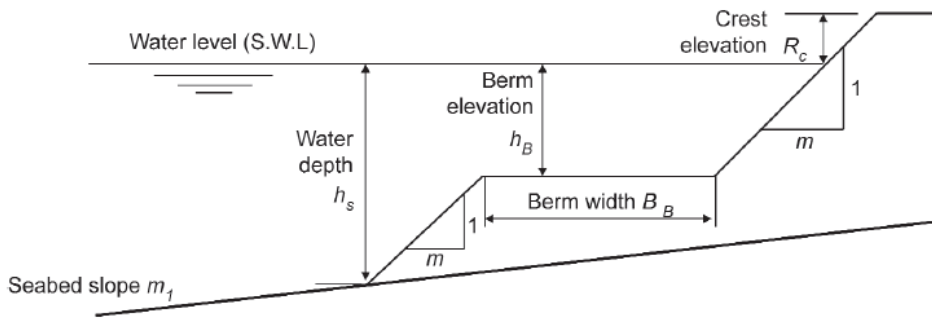

Figure 5.11



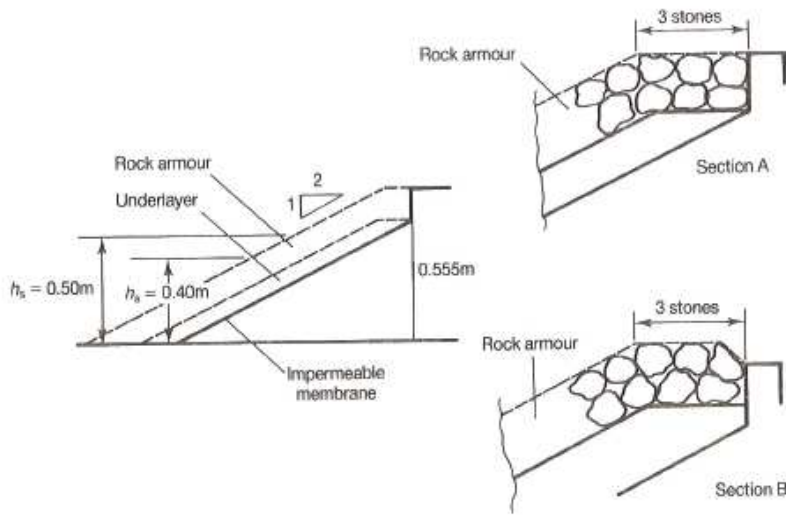

Figure 5.13

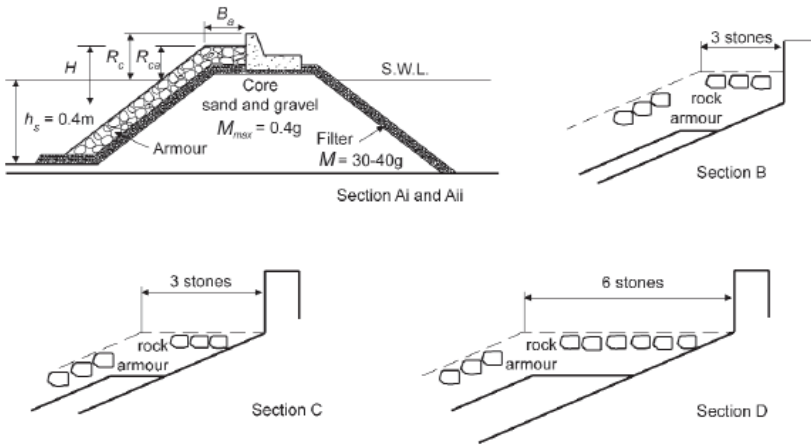

Figure 5.14

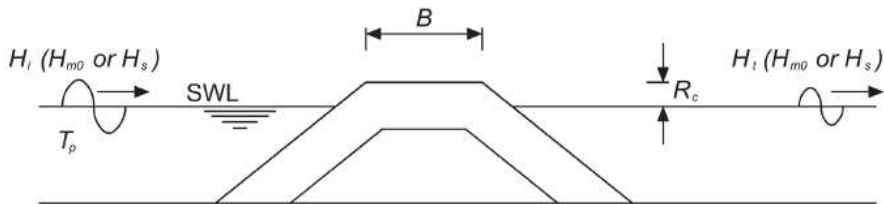

Figure 5.16

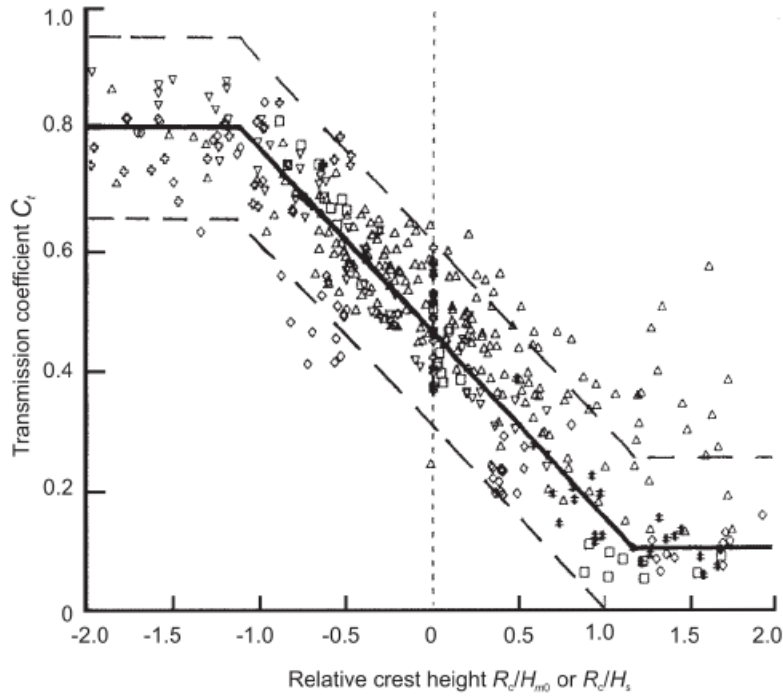

Figure 5.17

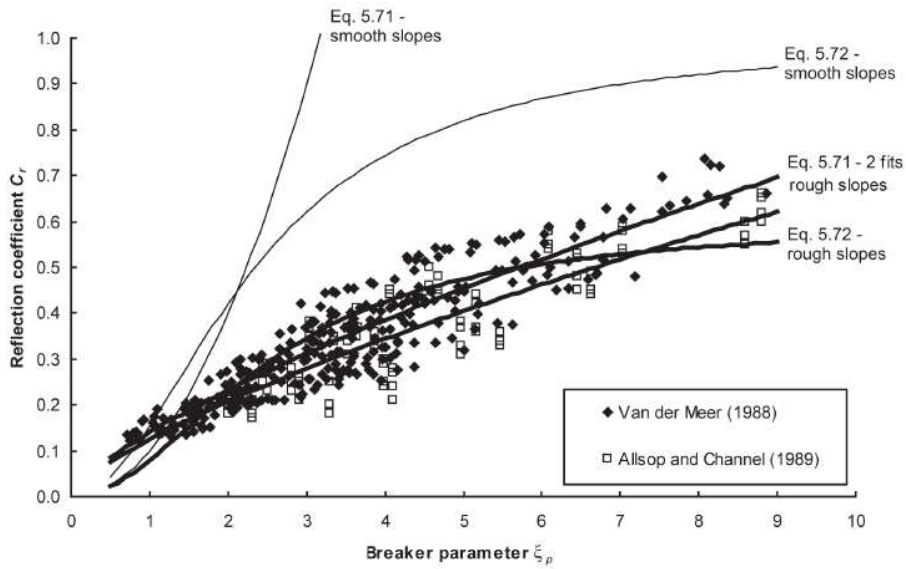

Figure 5.18

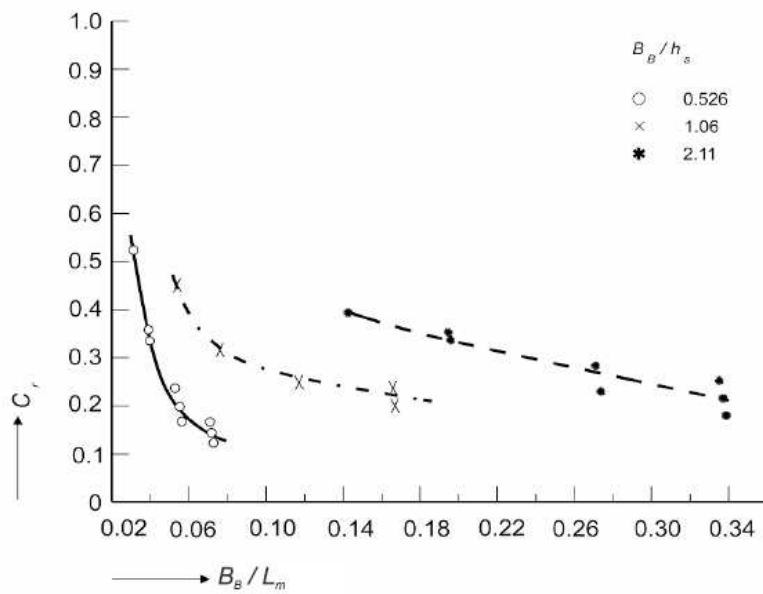
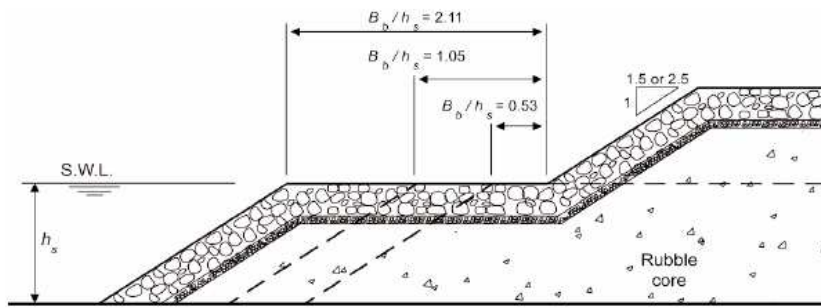
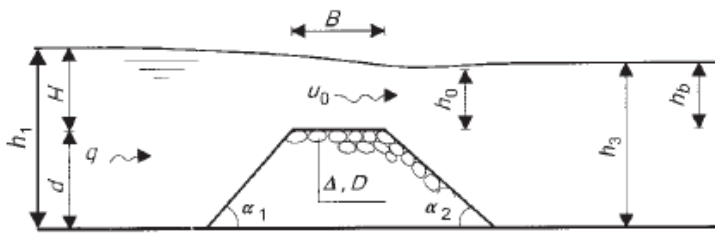

Figure 5.19

regime	flow	criterion
low dam flow		$\frac{h_b}{\Delta D} \geq 4$
intermediate flow		$-1 < \frac{h_b}{\Delta D} < 4$
high dam flow		$\frac{h_b}{\Delta D} < -1$ and $H > 0$
through flow		$H < 0$

Figure 5.20



Note:  $D$  should read  $D_{n50}$  in this figure

Figure 5.21

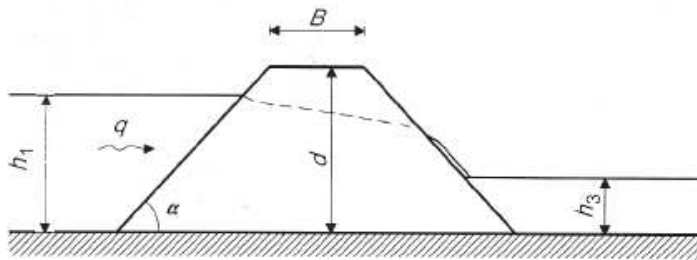
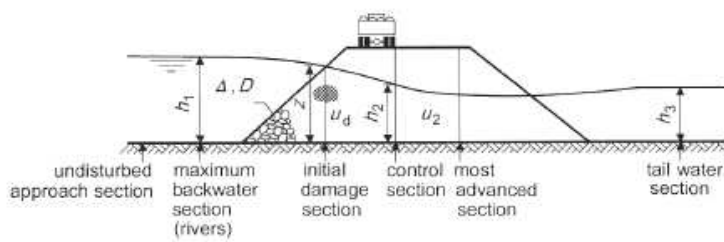
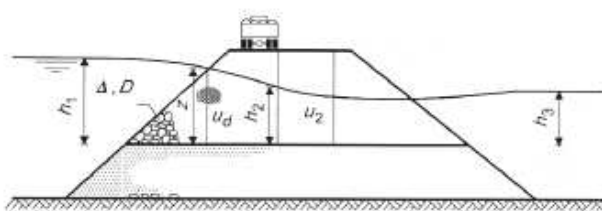

Figure 5.22



Note:  $D$  should read  $D_{n50}$  in this figure

Figure 5.23



Note:  $D$  should read  $D_{n50}$  in this figure

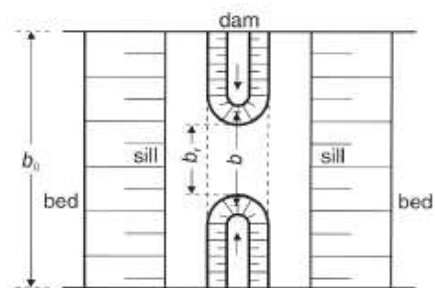

Figure 5.24

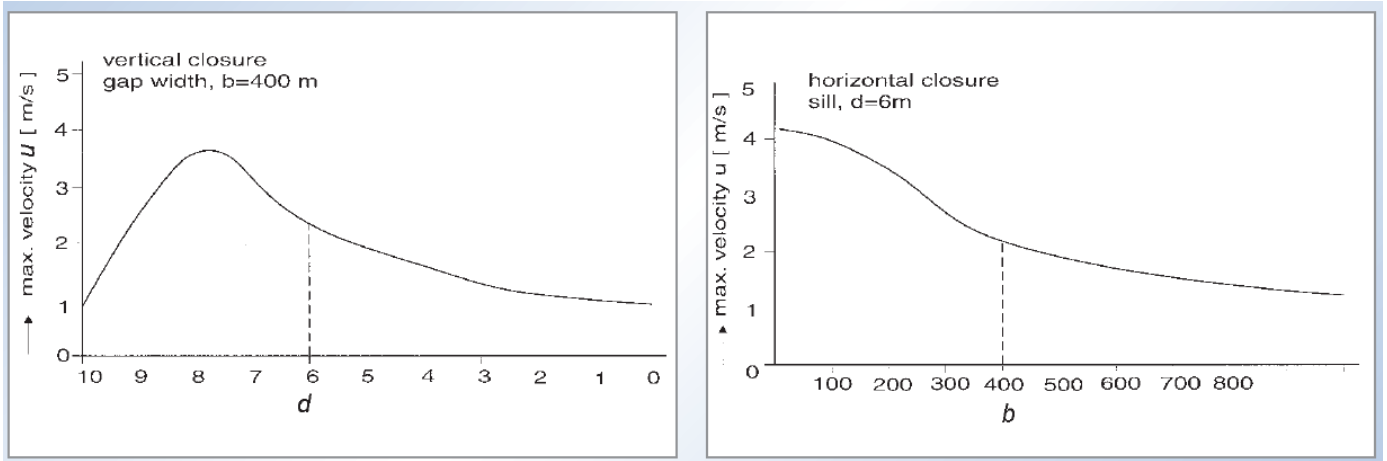

Figure 5.25

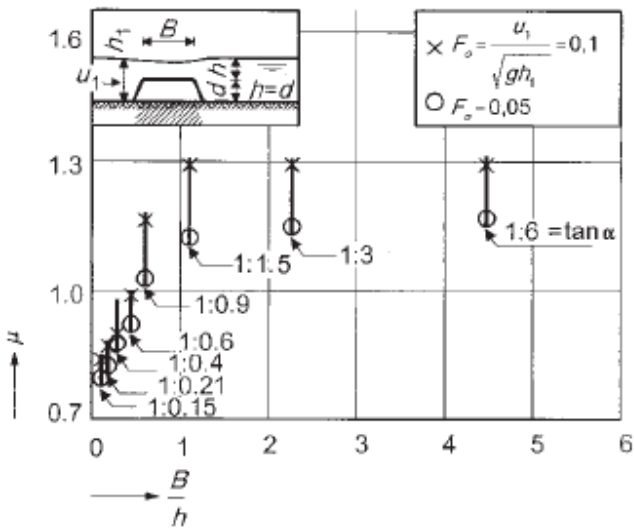

Figure 5.26

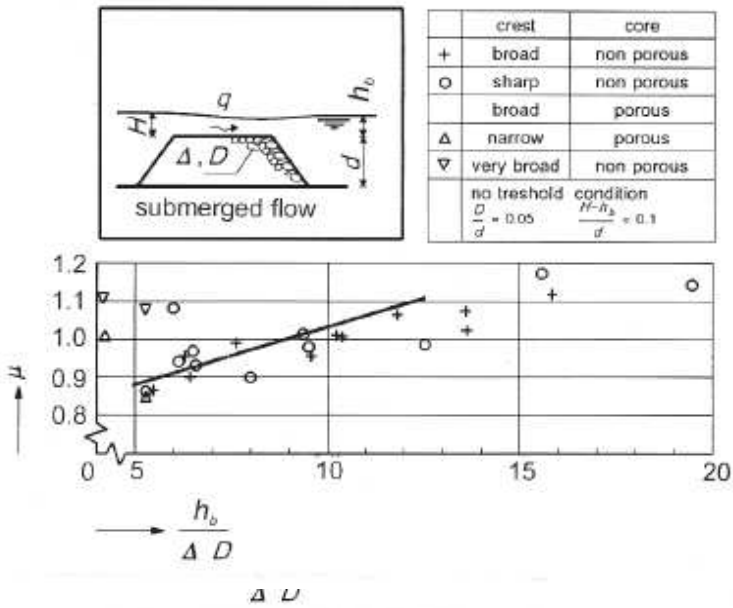
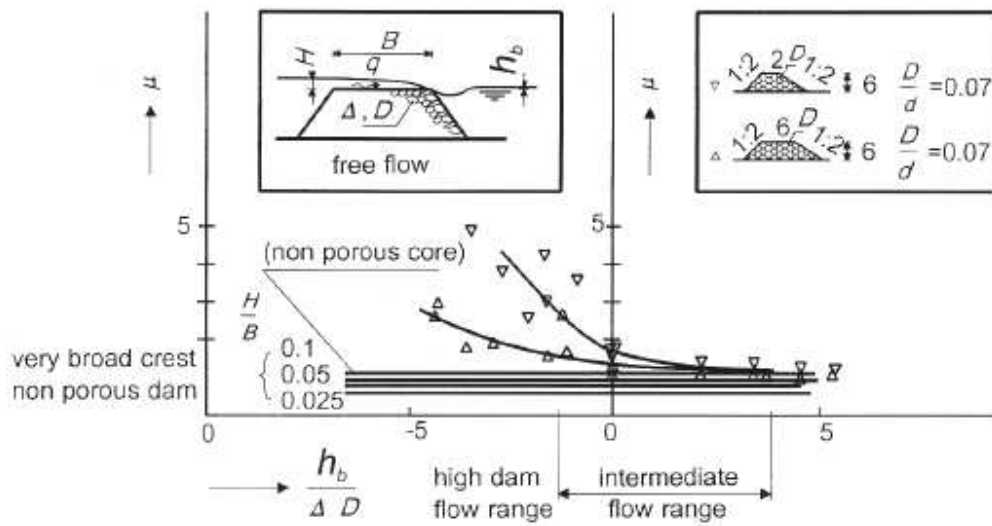

Figure 5.27  
dam and at the thre



Note:  $D$  should read  $D_{n50}$  in this figure

Figure 5.28

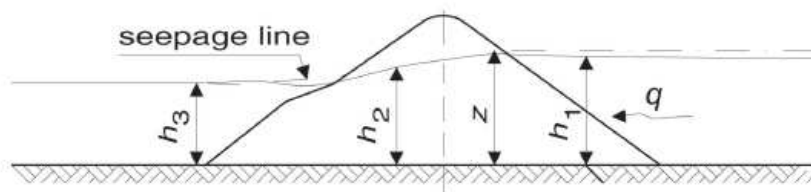
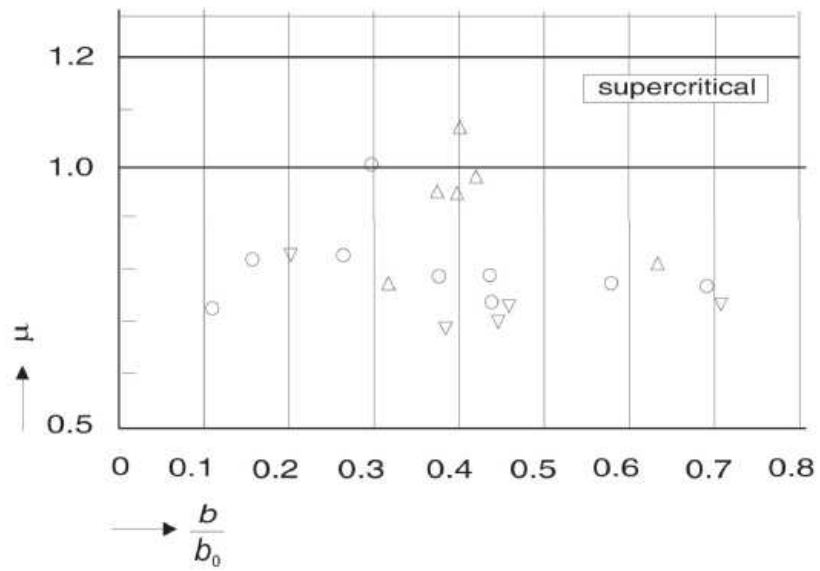
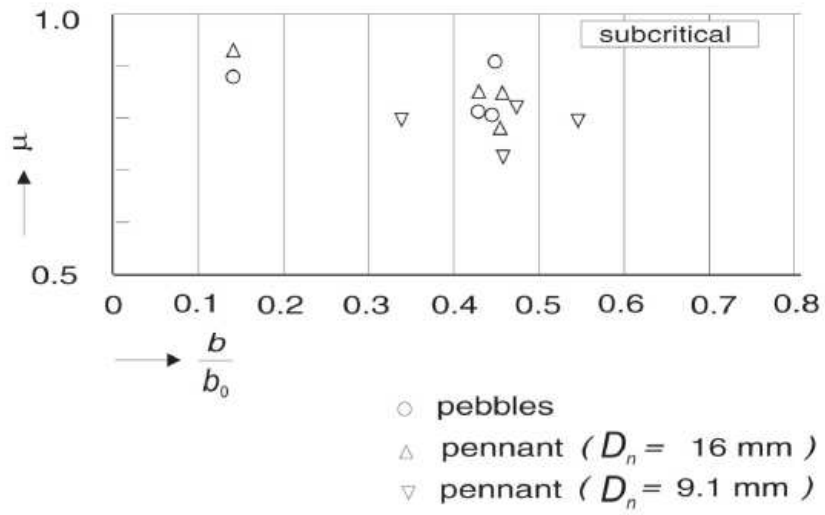

Figure 5.29

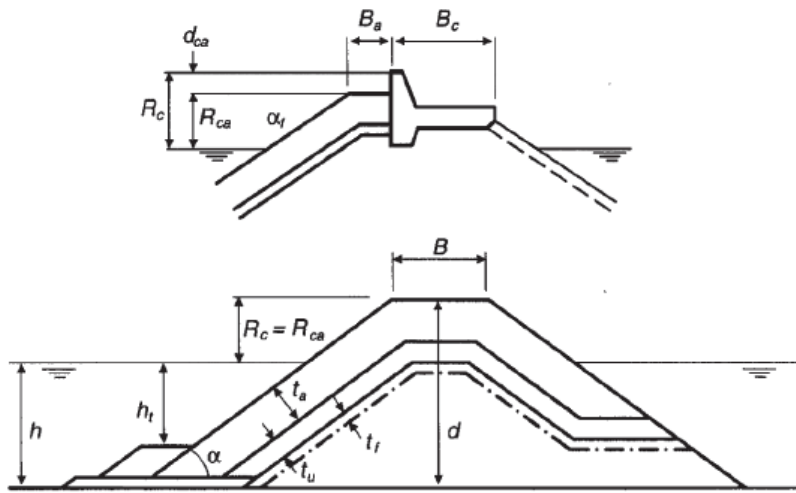

Figure 5.30

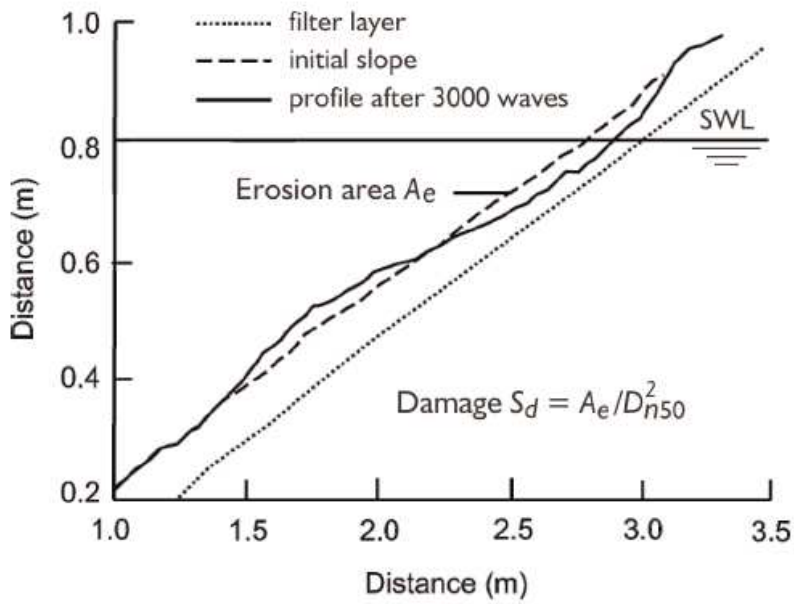

Figure 5.31



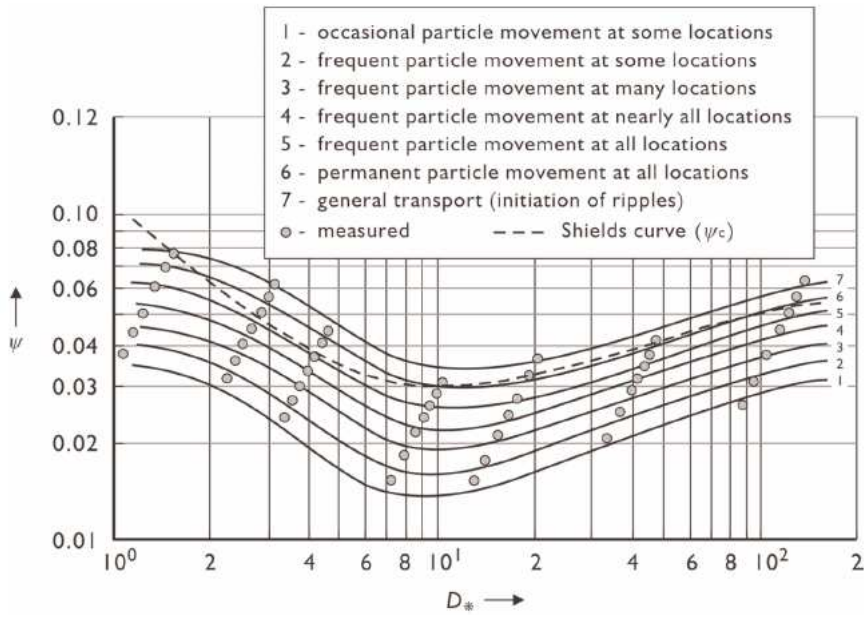

Figure 5.32

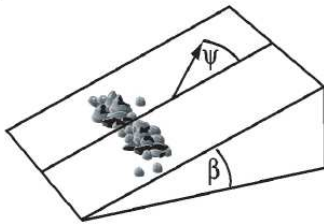
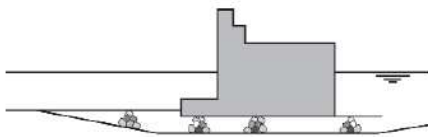
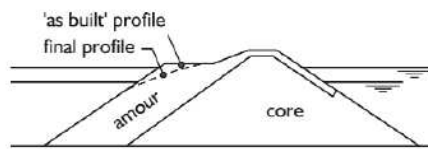

Figure 5.33



caisson  $H/\Delta D < 1$



berm breakwater  $H/\Delta D = 3 - 6$

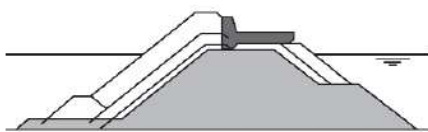

rubble mound breakwater  $H/\Delta D = 1 - 4$

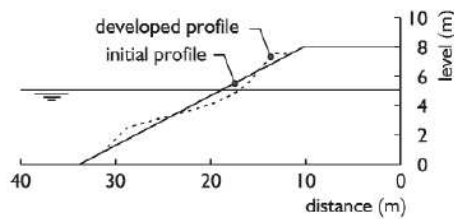

dynamic rock slope  $H/\Delta D = 6 - 20$

Figure 5.36

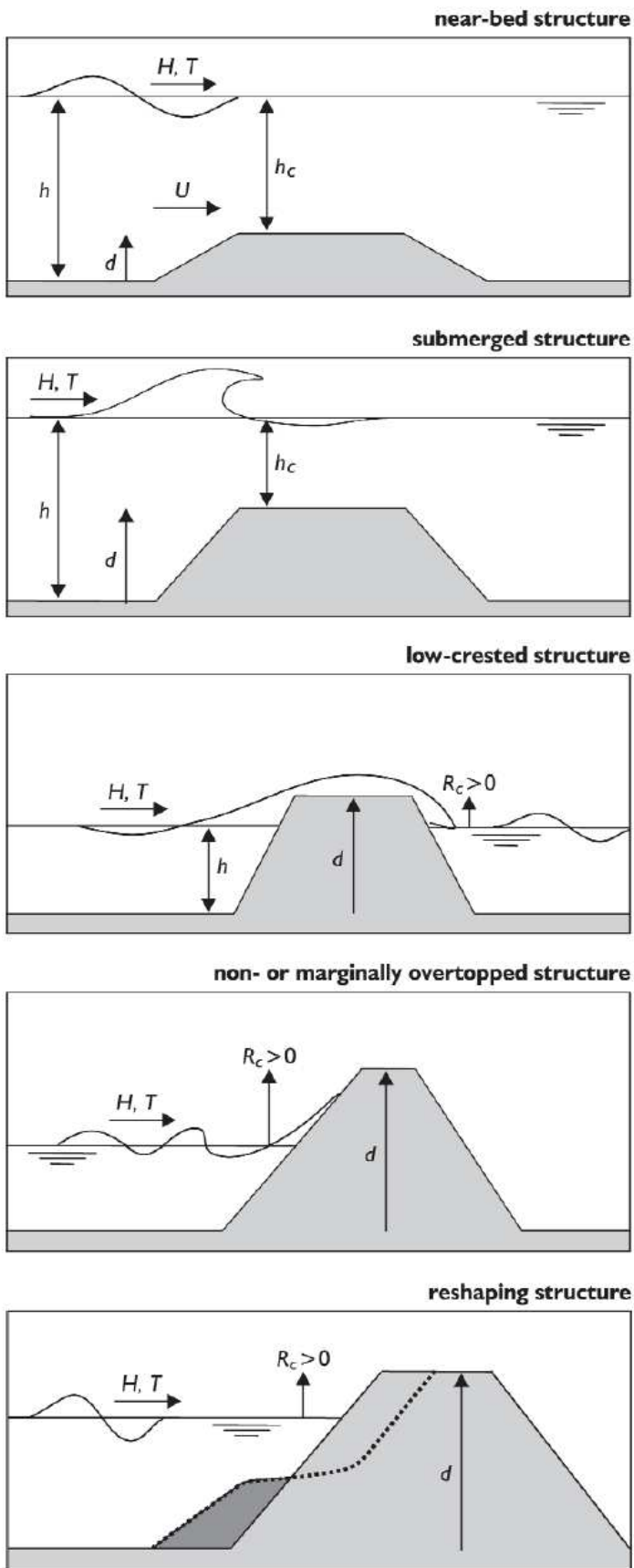

Figure 5.37

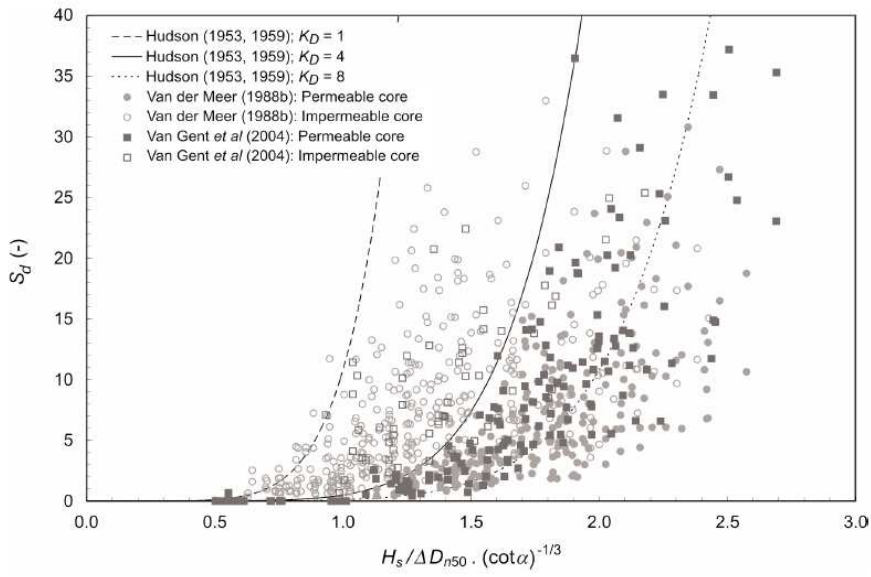
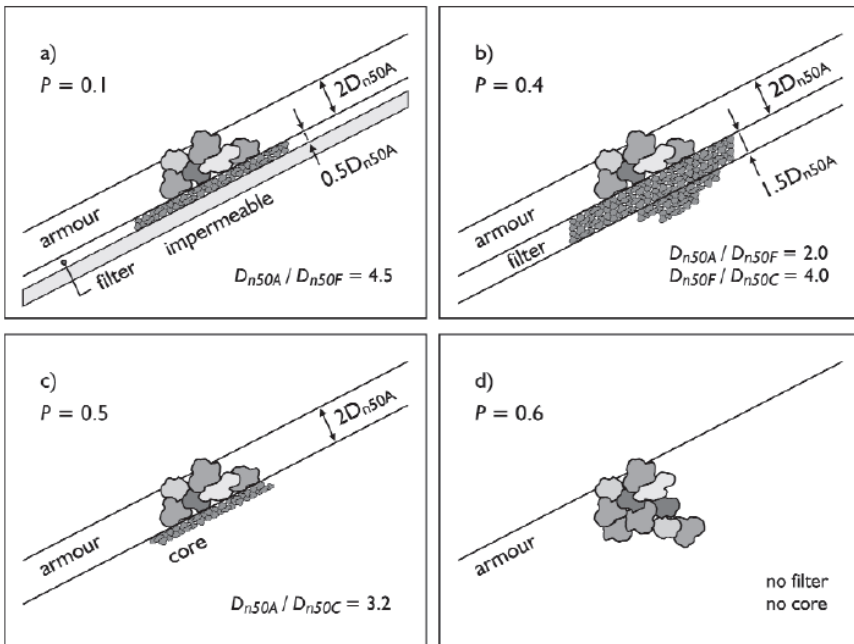

Figure 5.38



$D_{n50A}$  = nominal diameter of armour stone  
 $D_{n50F}$  = nominal diameter of filter material  
 $D_{n50C}$  = nominal diameter of core

Figure 5.39

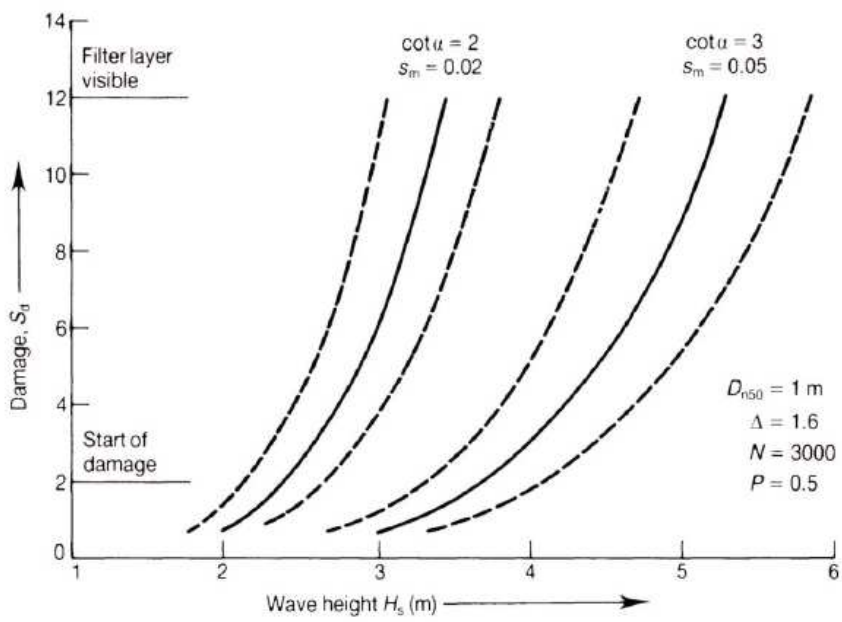

Figure 5.41

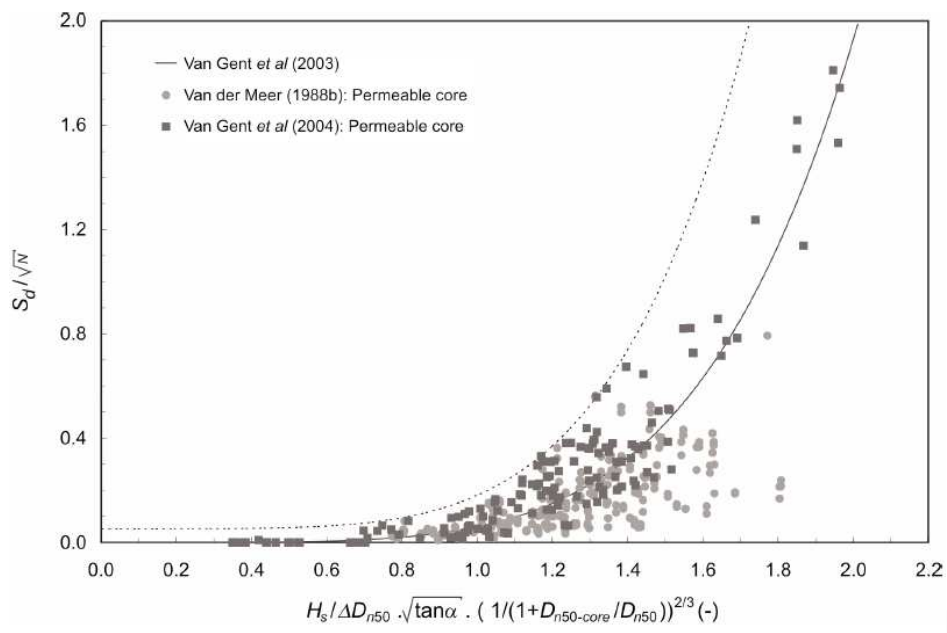

Figure 5.43

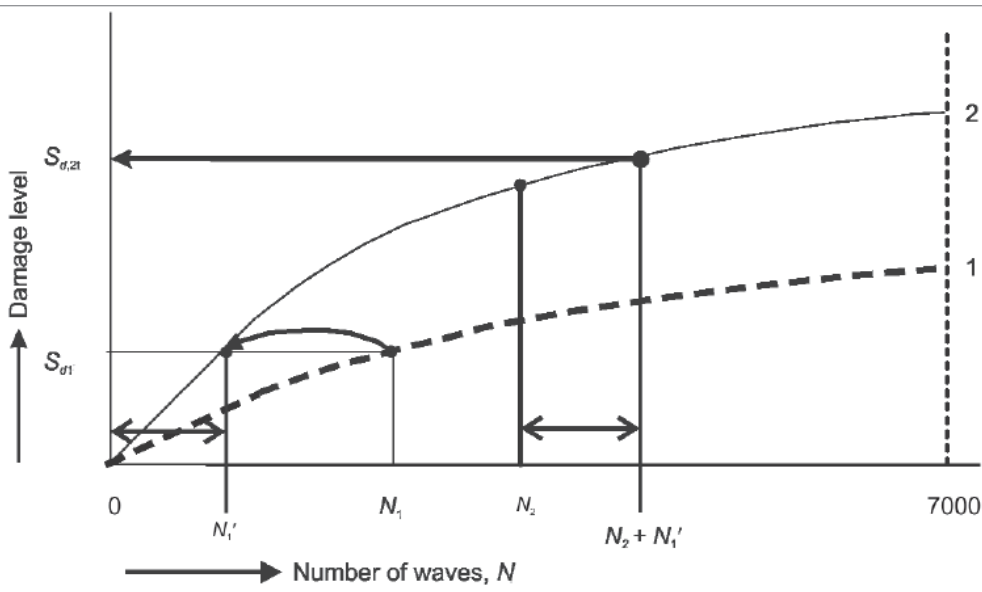

Figure 5.44

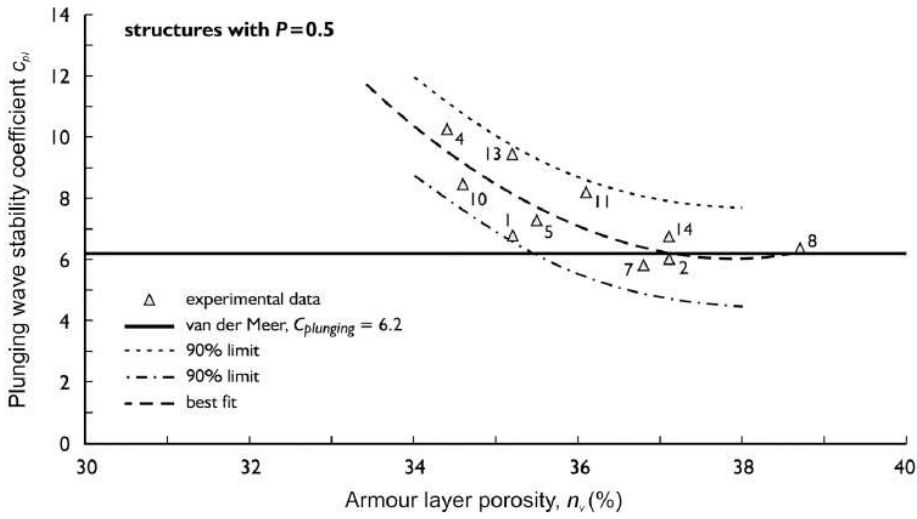

Figure 5.45

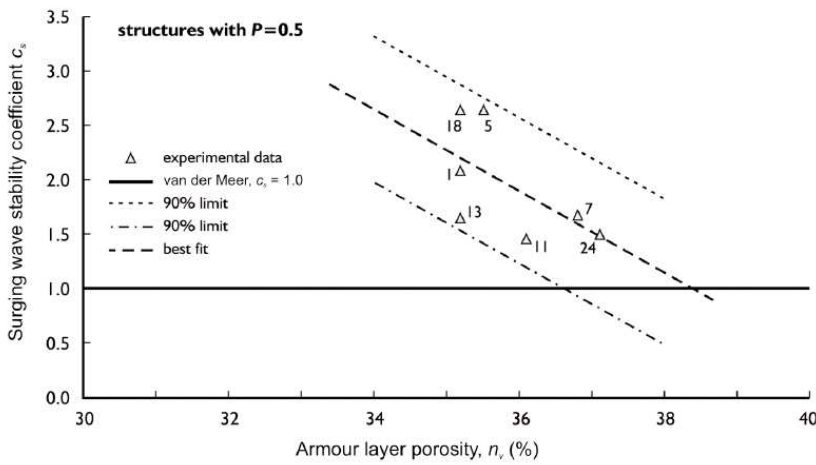

Figure 5.46

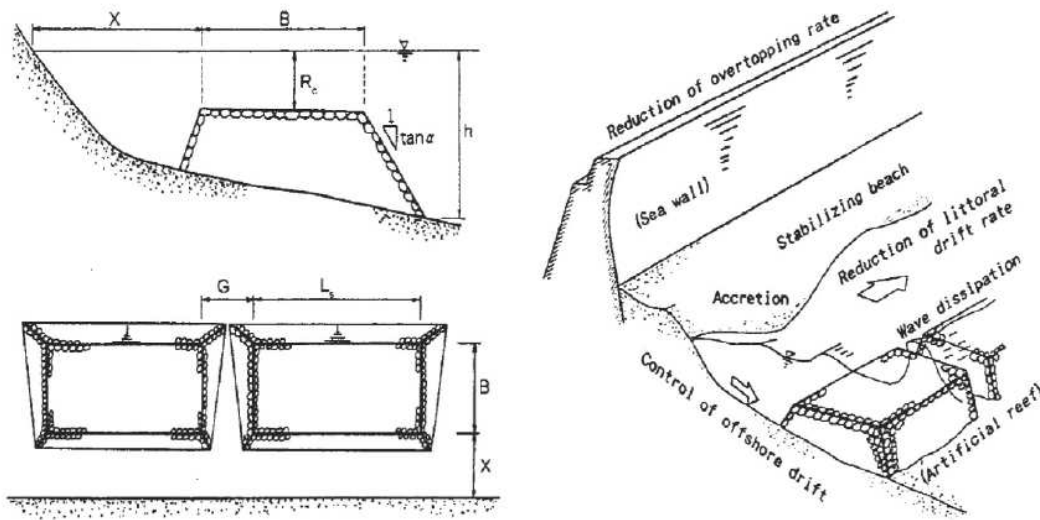

Figure 5.51

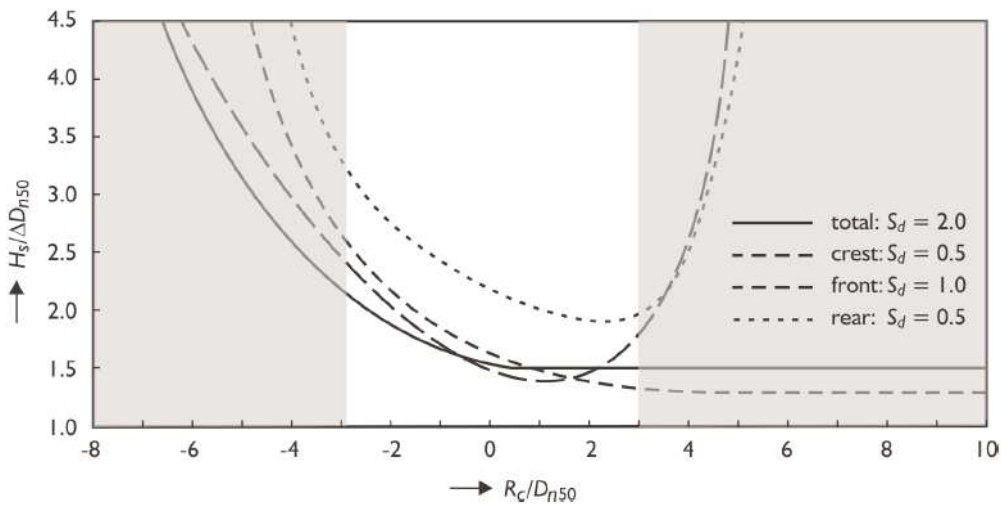

Figure 5.54

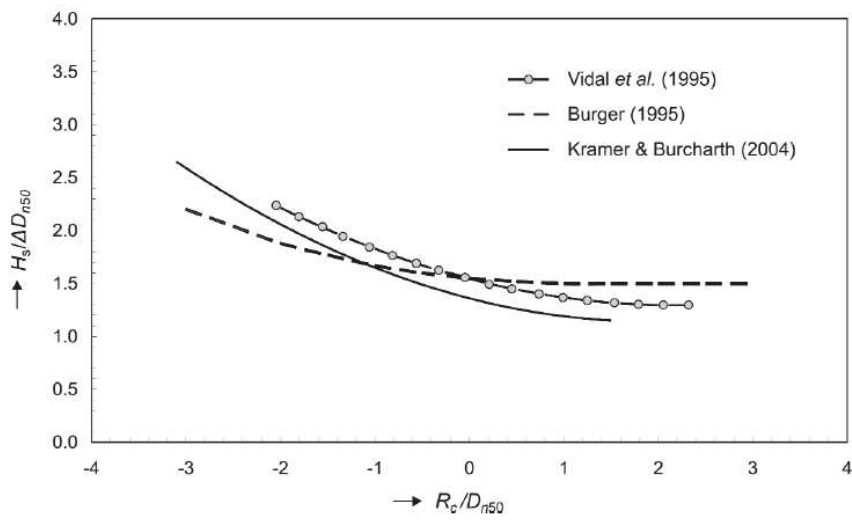

Figure 5.55

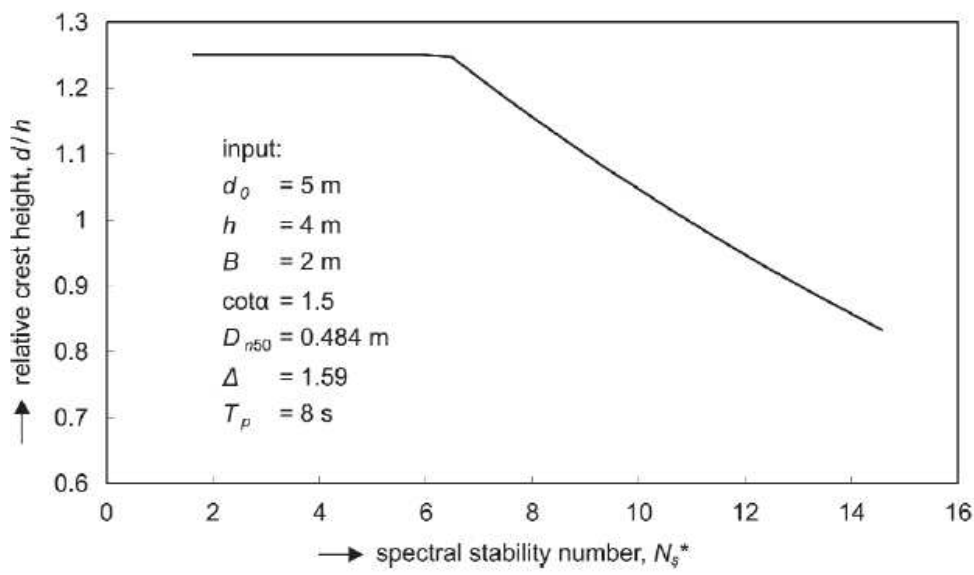

Figure 5.56

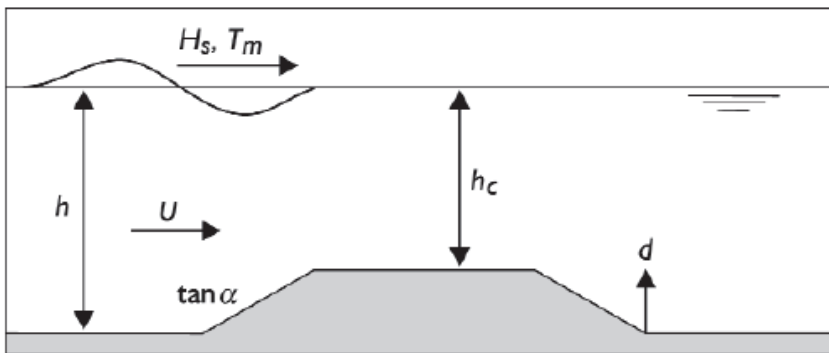

Figure 5.57

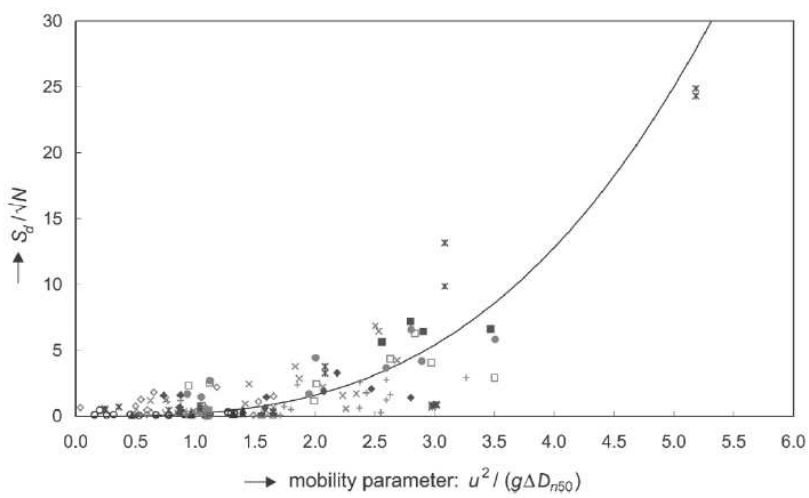

Figure 5.58

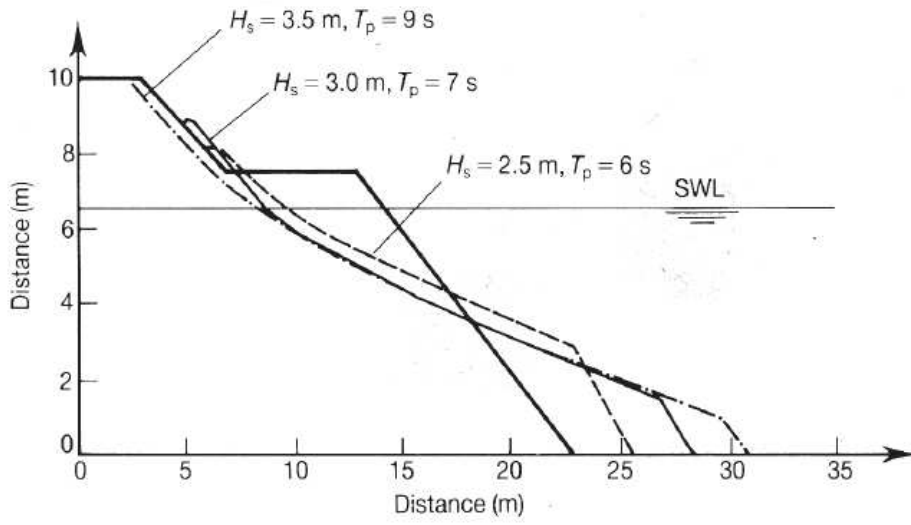

Figure 5.62

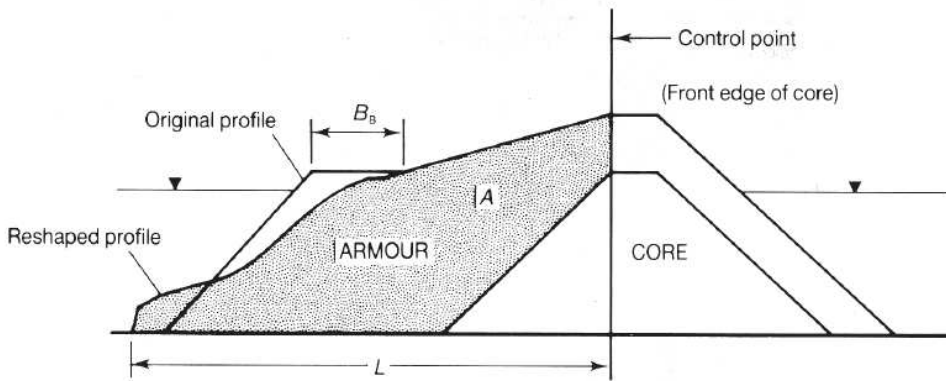

Figure 5.64

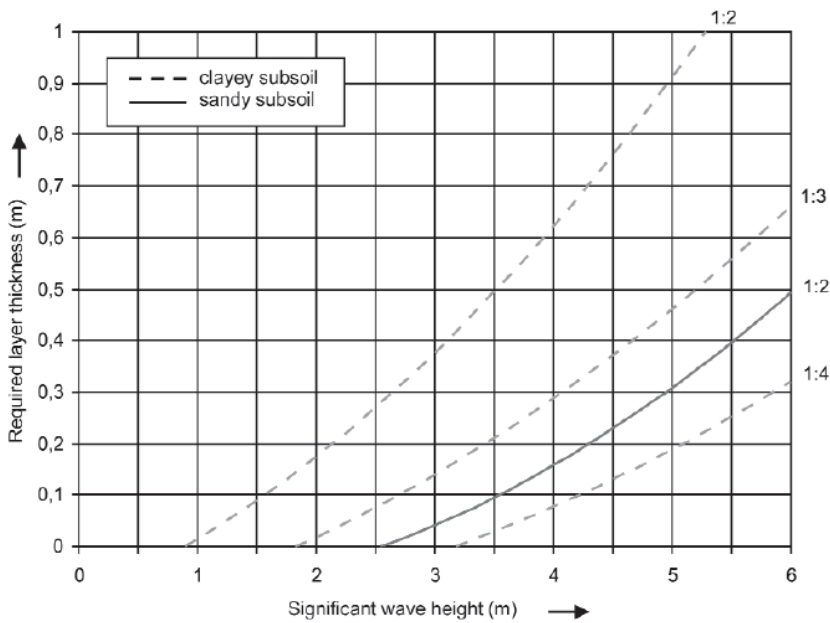

Figure 5.68



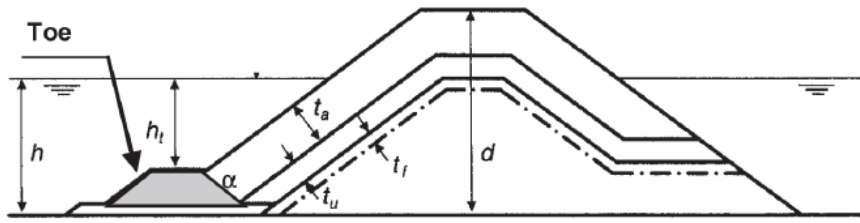

Figure 5.72

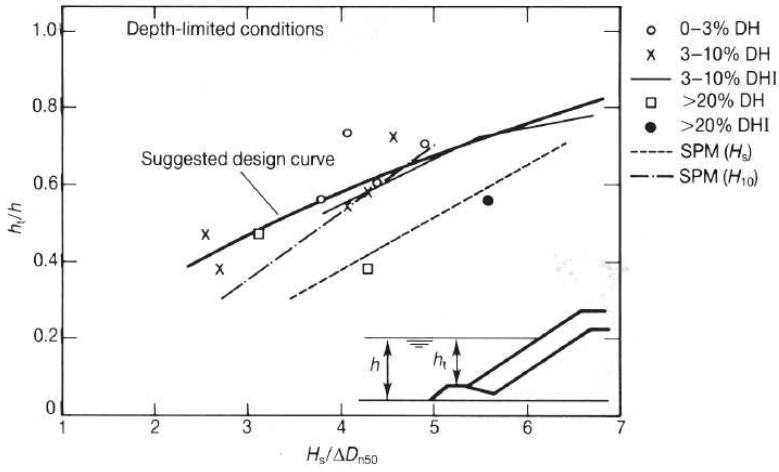

Figure 5.73

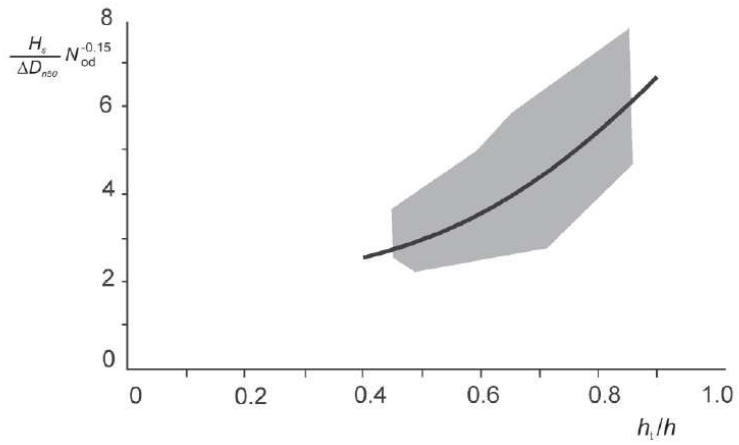
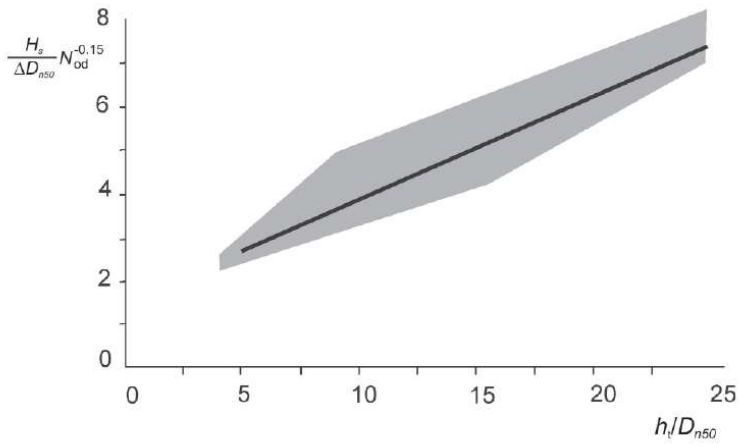

Figure 5.74

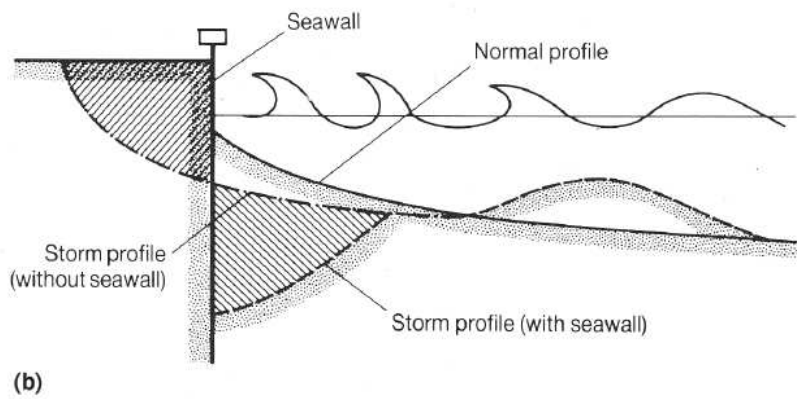
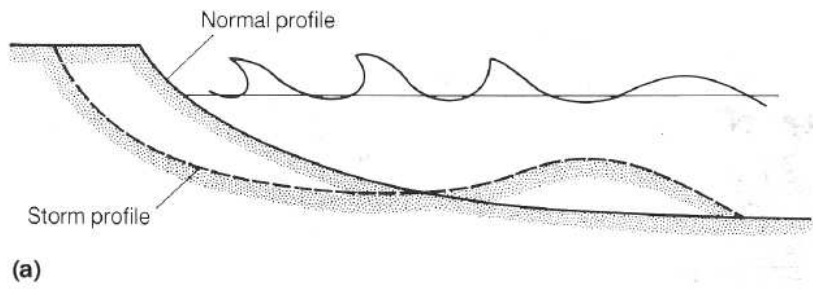

Figure 5.77

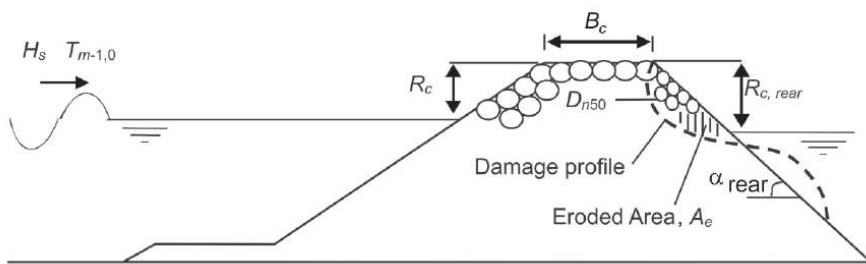

Figure 5.78

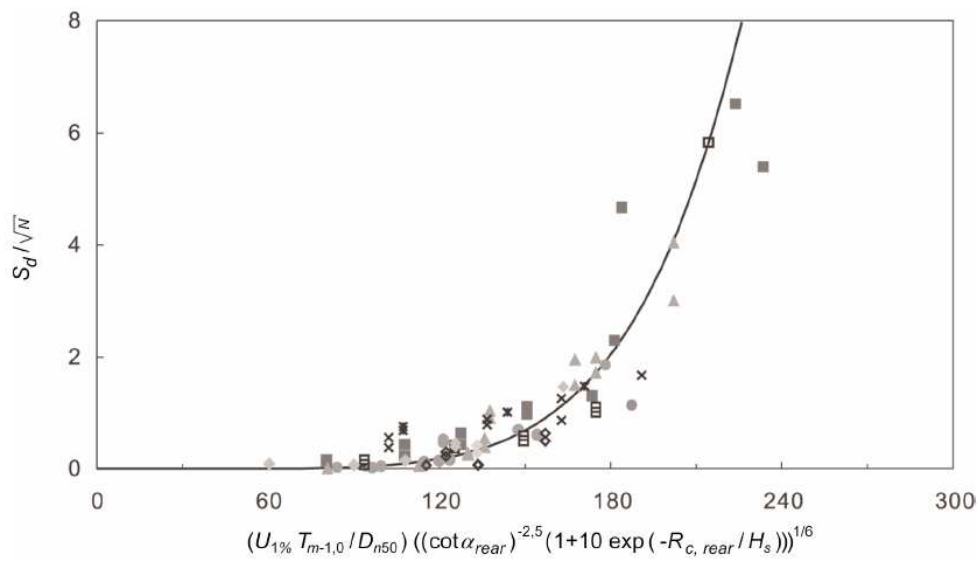

Figure 5.79

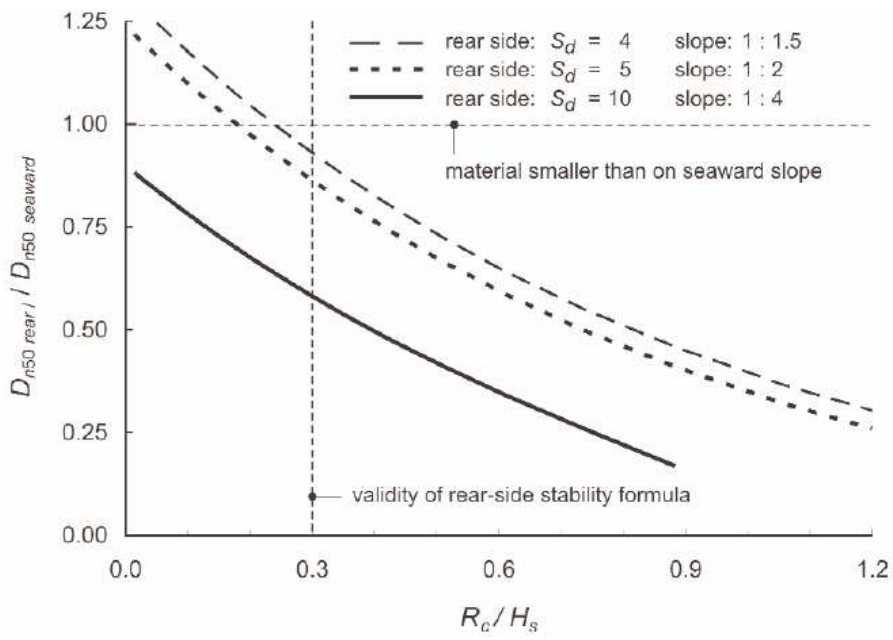

Figure 5.80

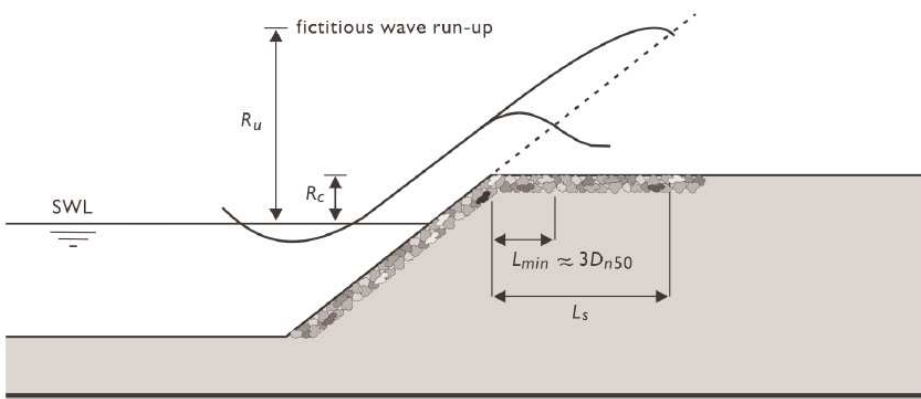

Figure 5.81

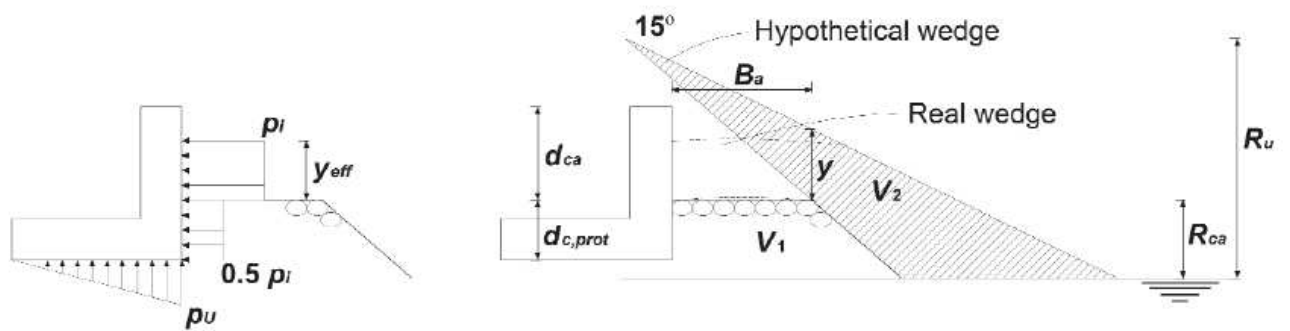

Figure 5.83

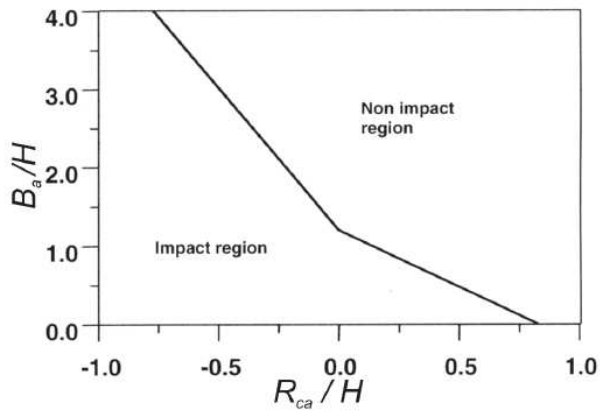

Figure 5.84

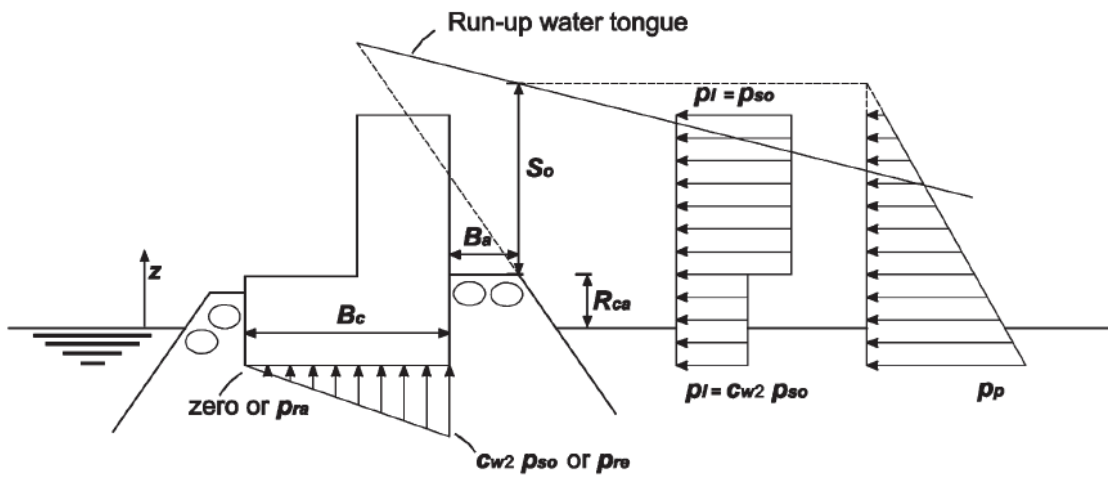

Figure 5.85

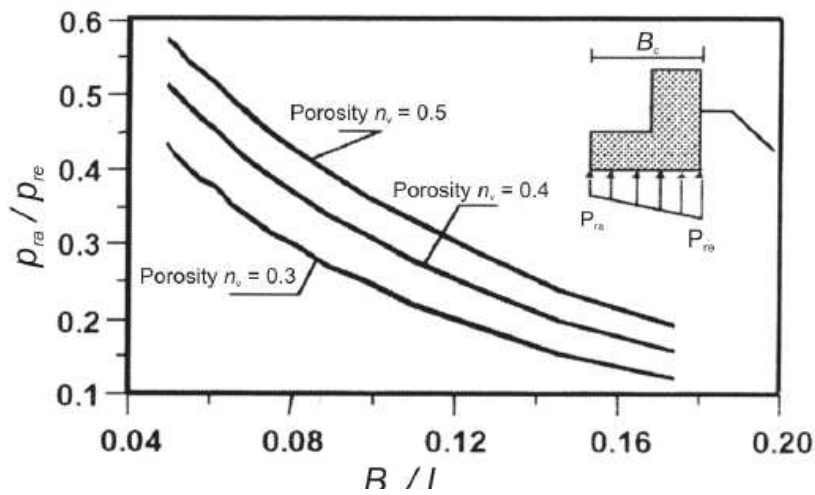
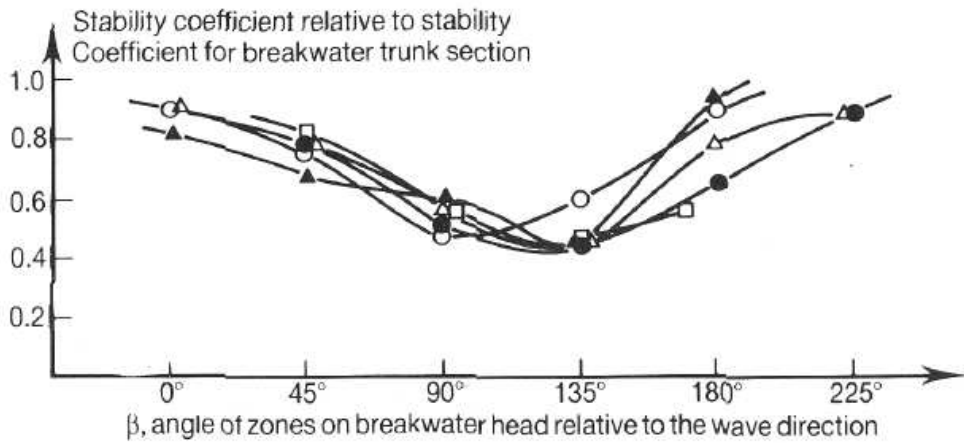

Figure 5.87



Legend  
Wave direction  $\alpha$

- 50°
- △ 70°
- 90°
- ▲ 110°
- 130°

Note  
Slope 1 : 1.33  
Wave steepness  $s_{0D} \approx 0.035$

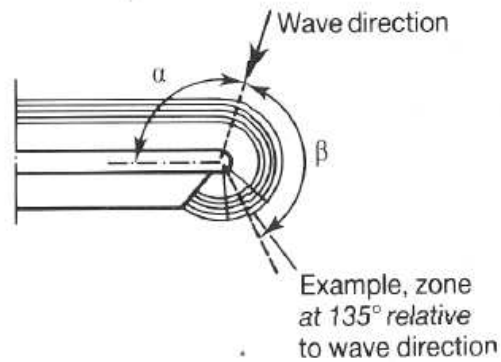
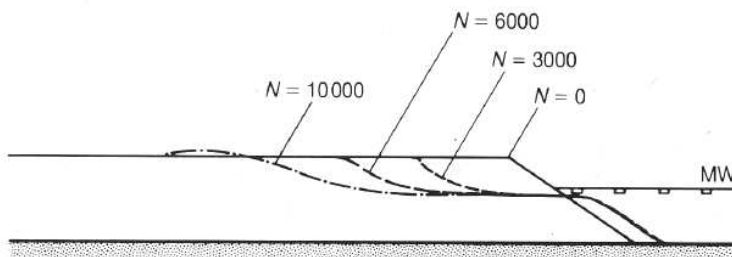

Figure 5.88



$H_s = 0.15$  m,  $T_p = 2.5$  s

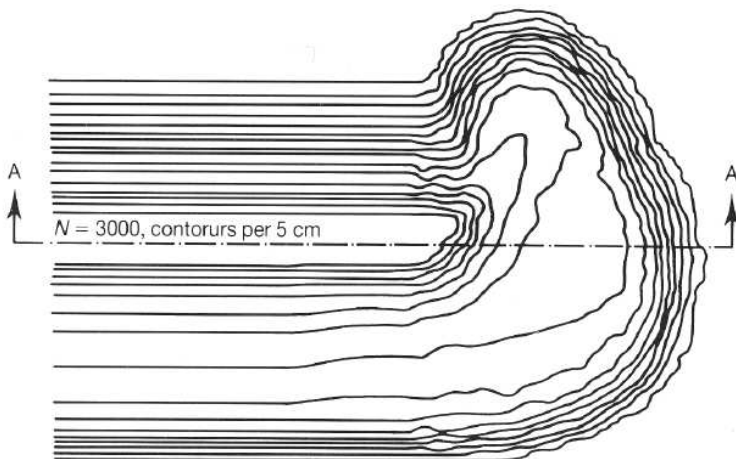

Figure 5.91

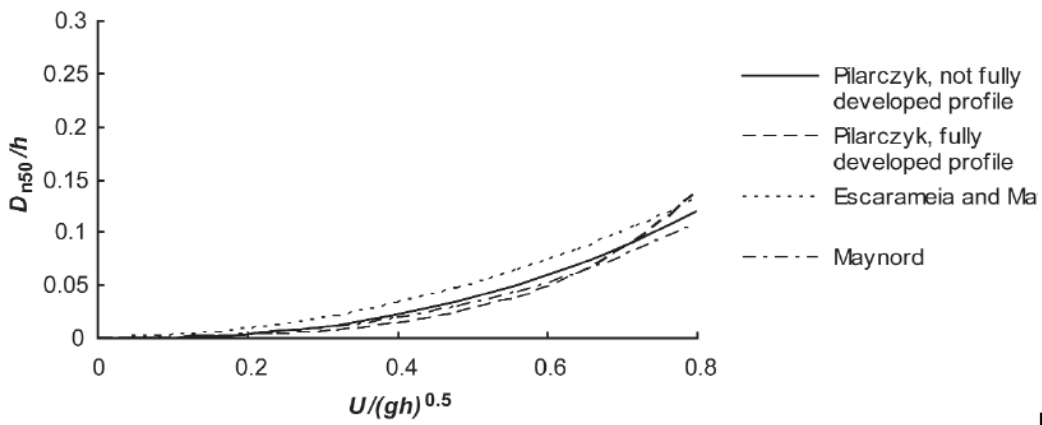

Figure 5.93

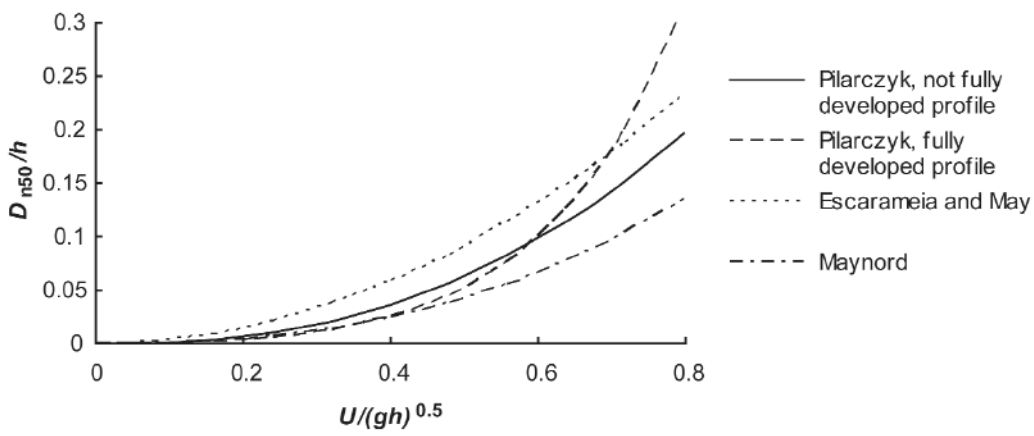

Figure 5.94

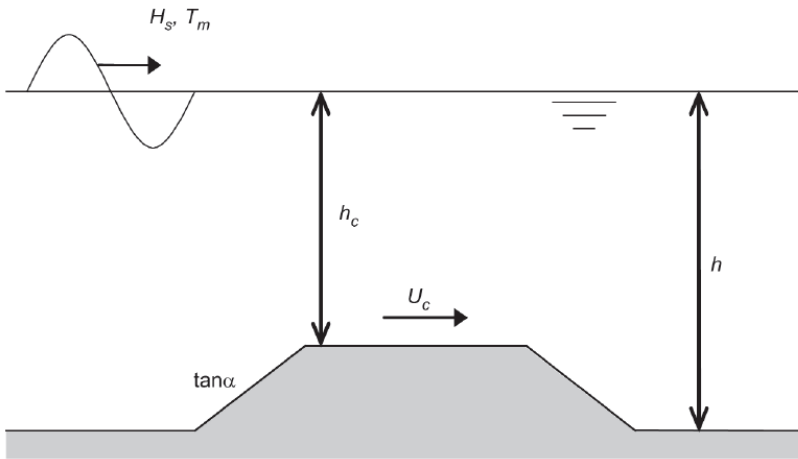

Figure 5.95

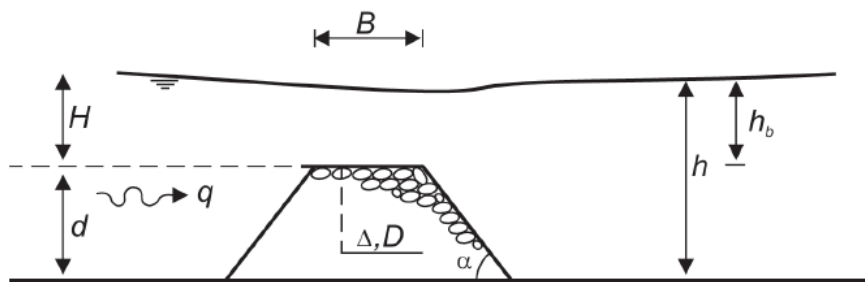

Figure 5.96

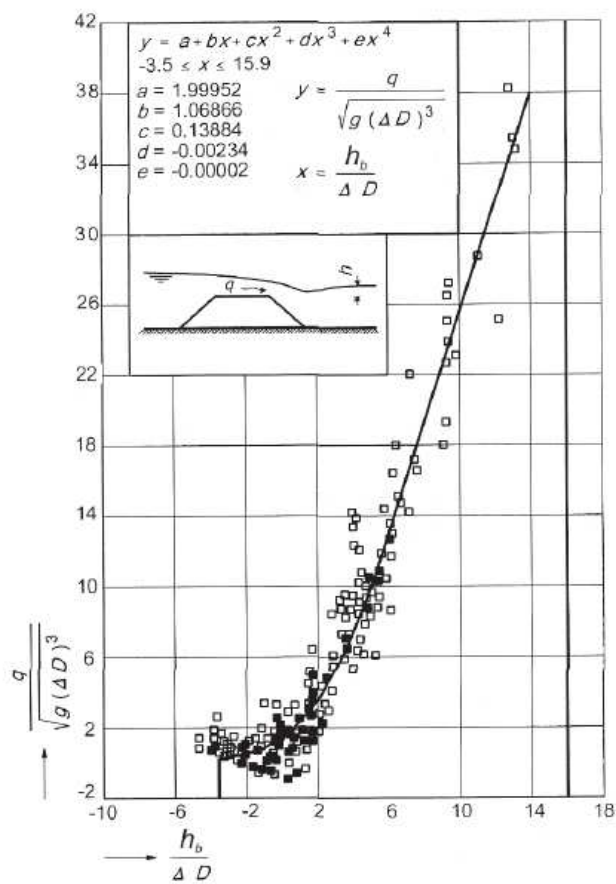
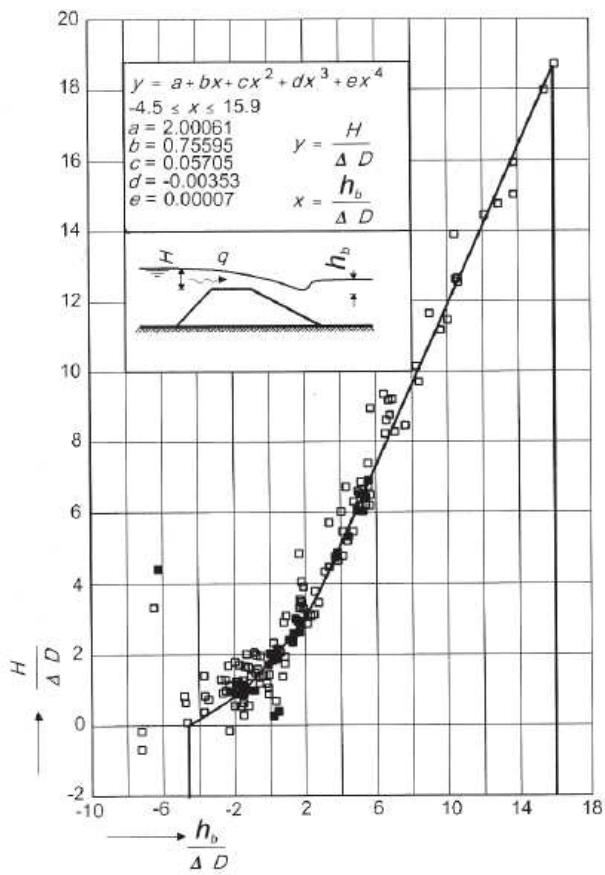

Figure 5.97/5.98

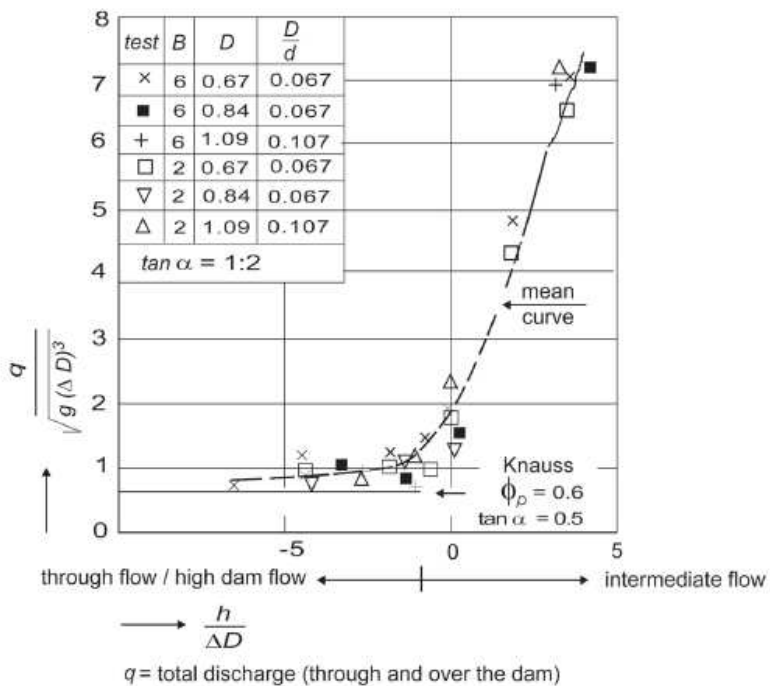

Figure 5.100

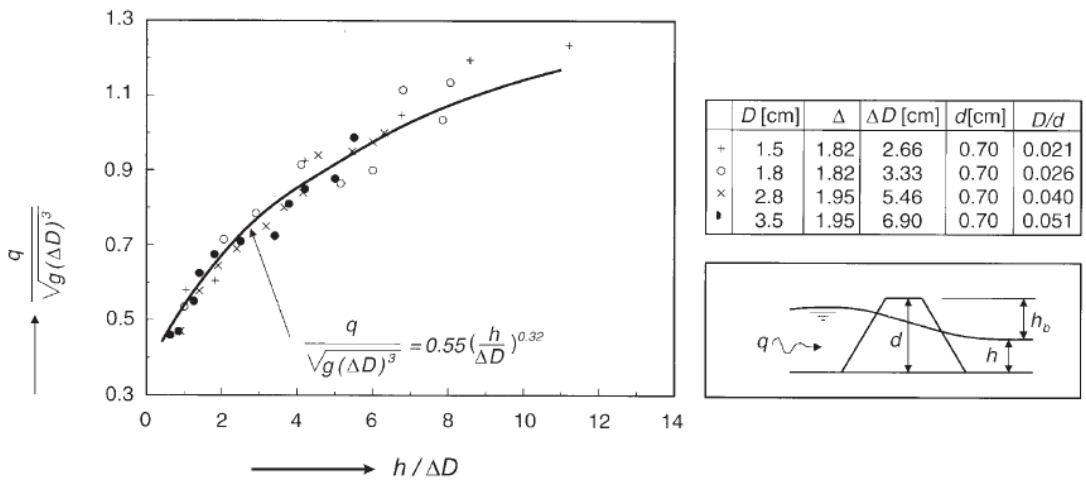

Figure 5.101

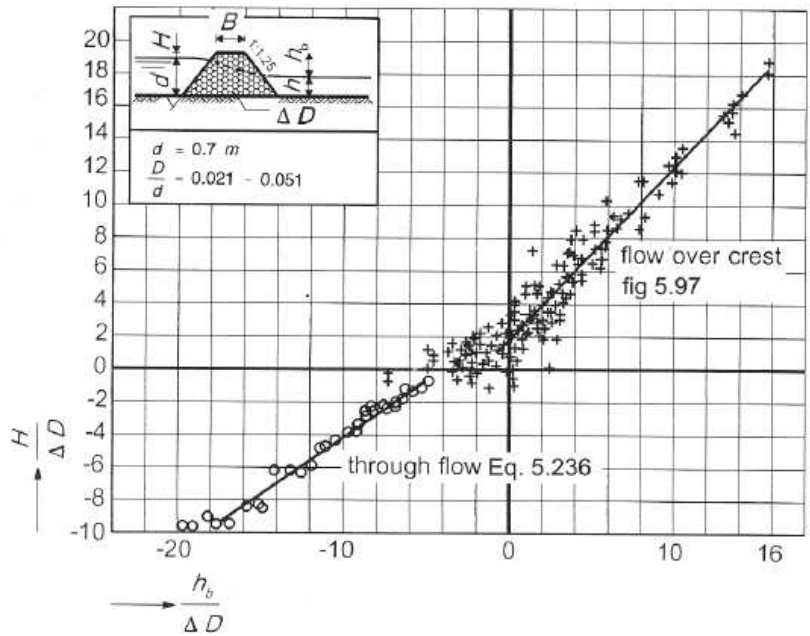

Figure 5.102

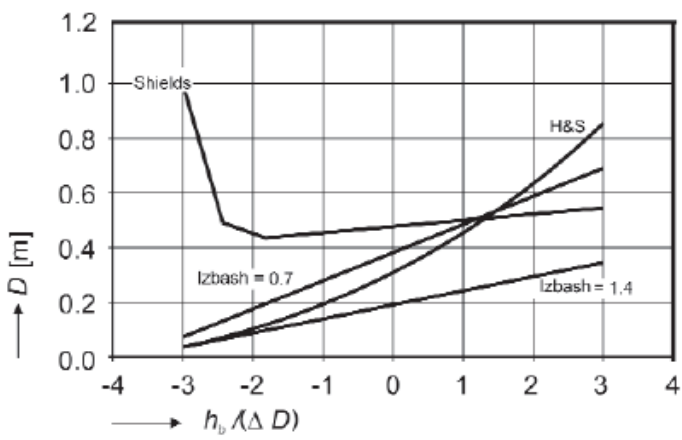
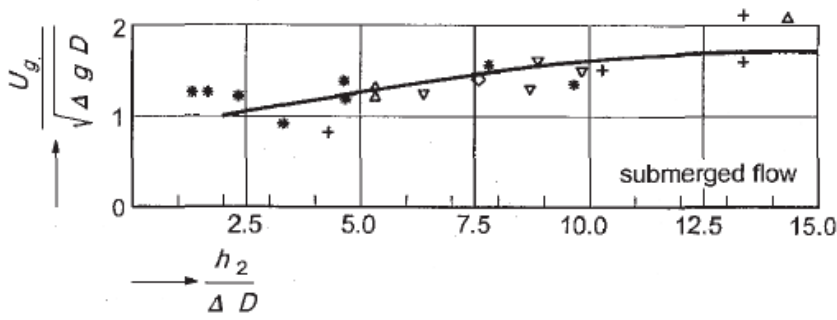
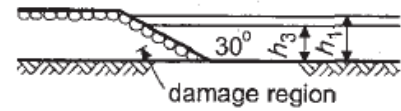

Figure 5.103





	stone dimension $\Delta D$ (m)
+ pebbles	0.0251
$\Delta$ pennant Naylor	0.0175
$\nabla$ pennant	0.0108
* Das	0.0111
	0.0294
$\square$ Shire river	0.9700
$\diamond$ Mangla Dam	0.6300
pretipped dams (stones dumped at still water)	



$$\frac{U_g}{\sqrt{\Delta g D}} = \log \left( \frac{3h_3}{D} \right) \text{ when } \Delta = 1.65$$

$h_1$  = upstream water depth  
 $h_3$  = downstream water depth  
 $h_{con}$  = control water depth

$$U_g = \frac{Q}{bz}, \quad z = \frac{(2h_1 + h_2)}{3}$$

$h_2 = h_3$  for submerged flow  
 $h_2 = h_{con}$  for supercritical flow

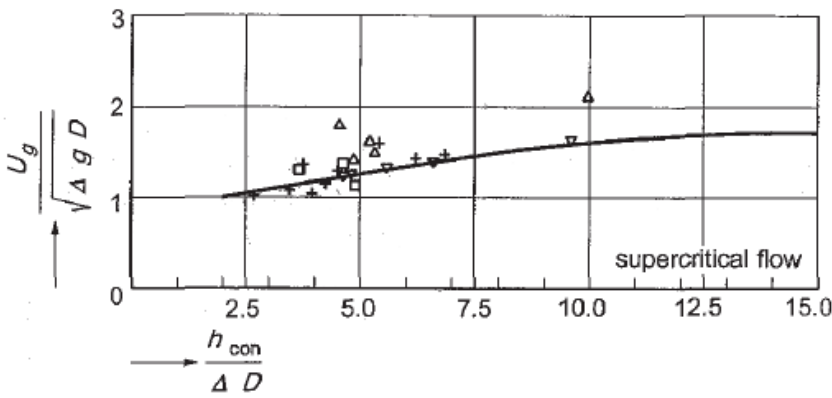

Figure 5.106

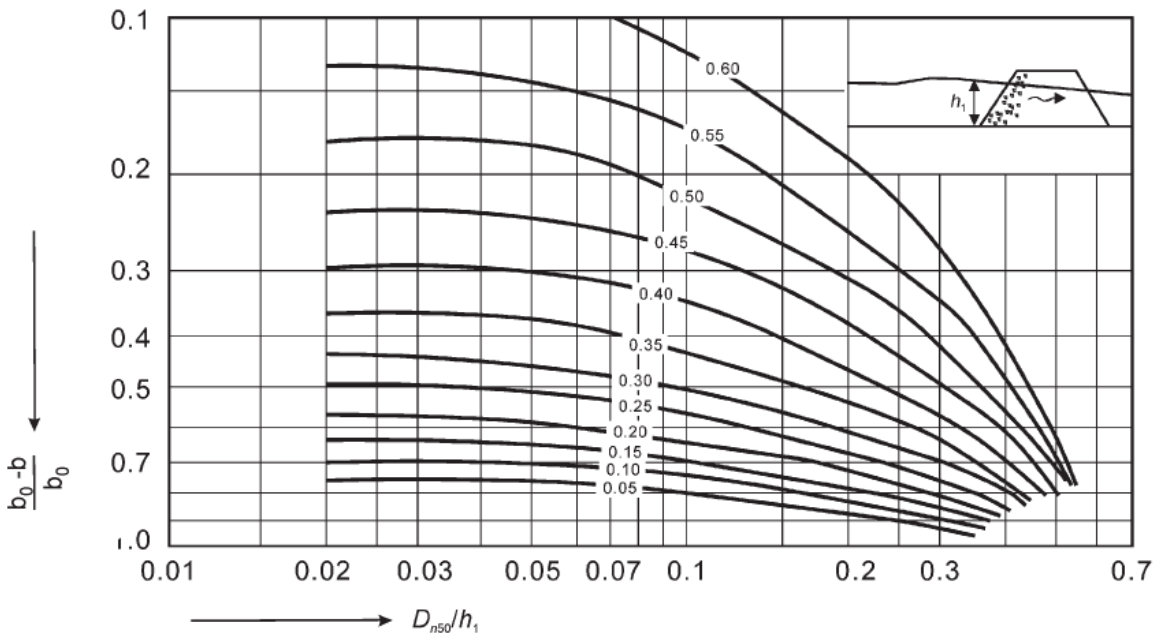

Figure 5.107

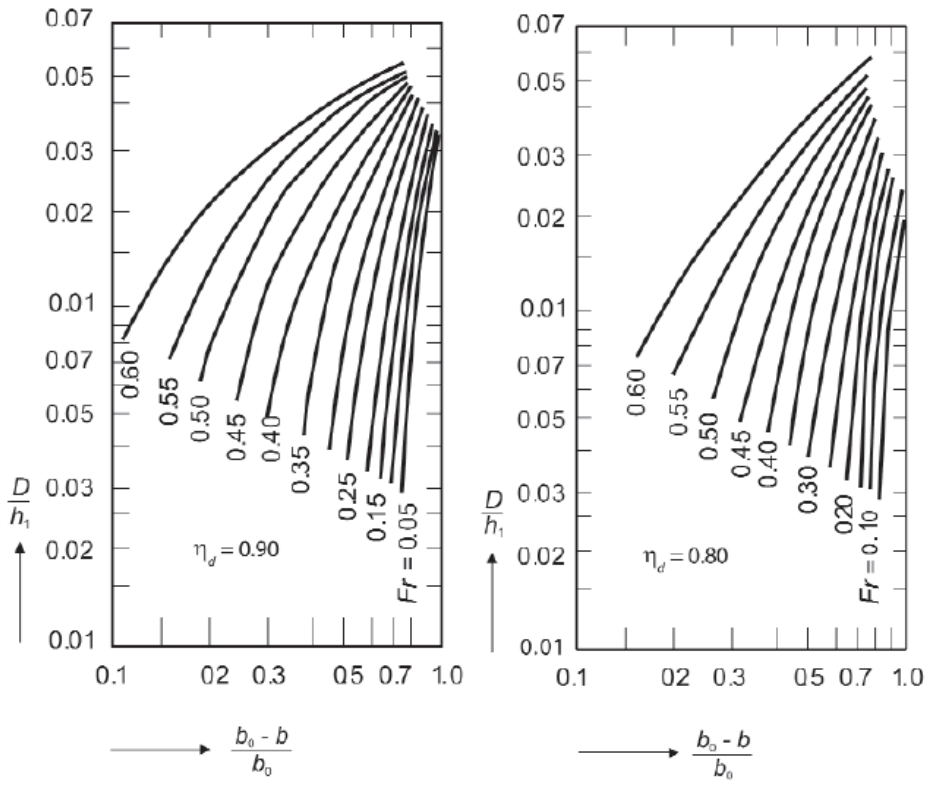

Figure 5.108

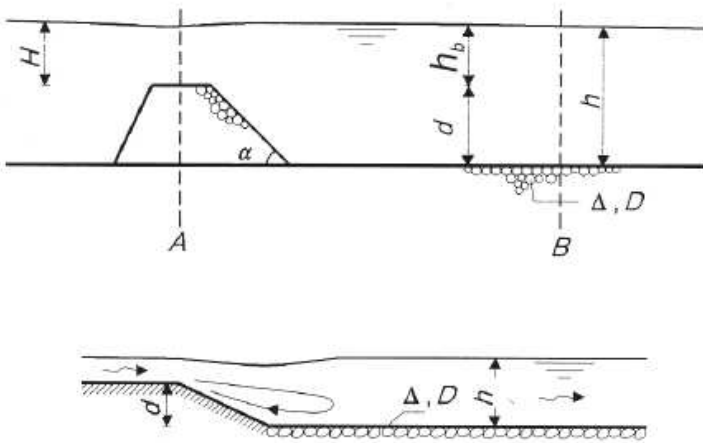

Figure 5.109

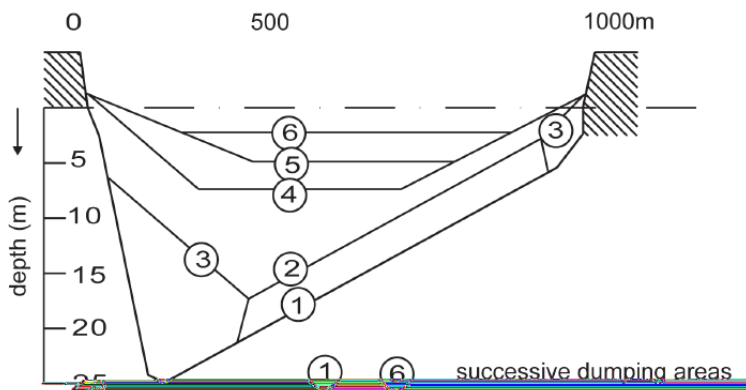

Figure 5.110

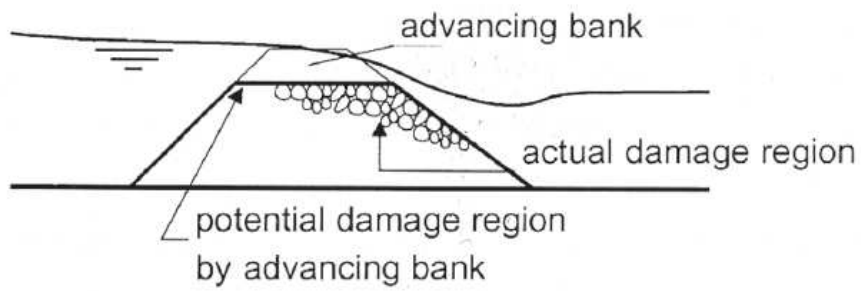

Figure 5.111

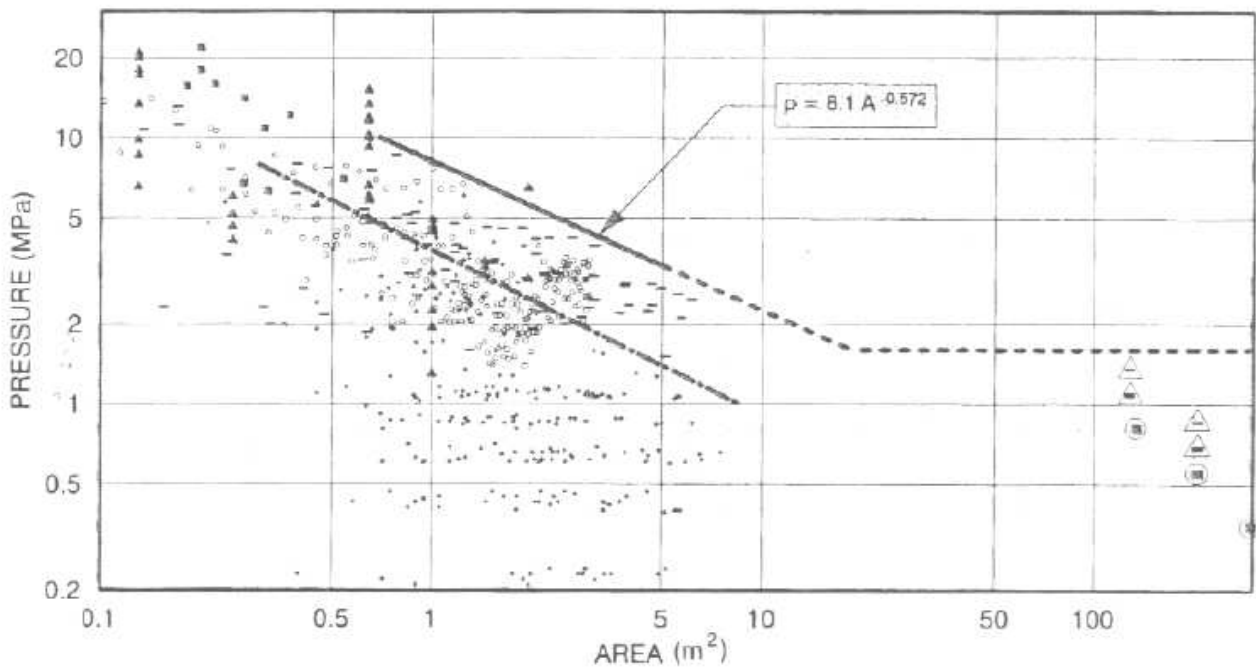

Figure 5.112

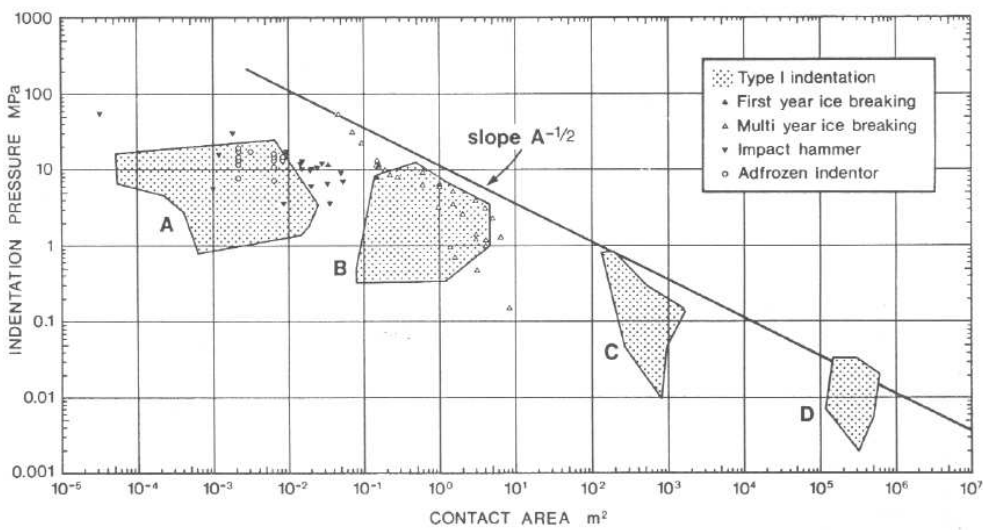

Figure 5.113

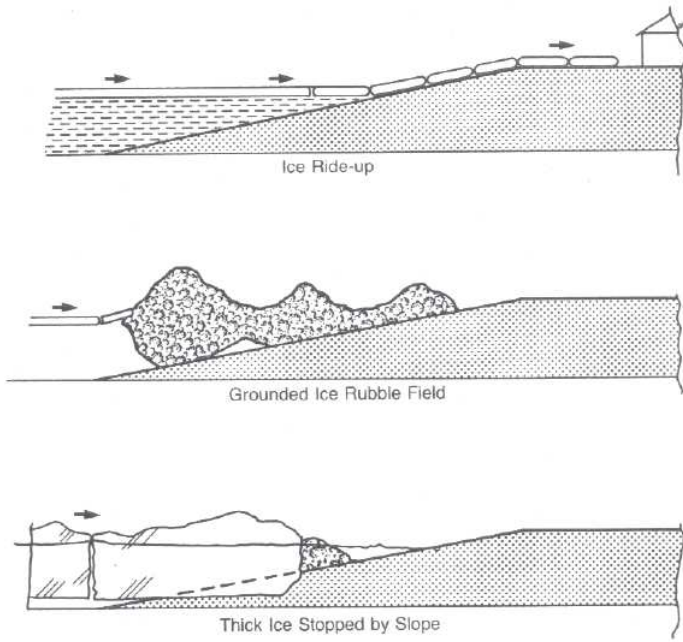

Figure 5.114

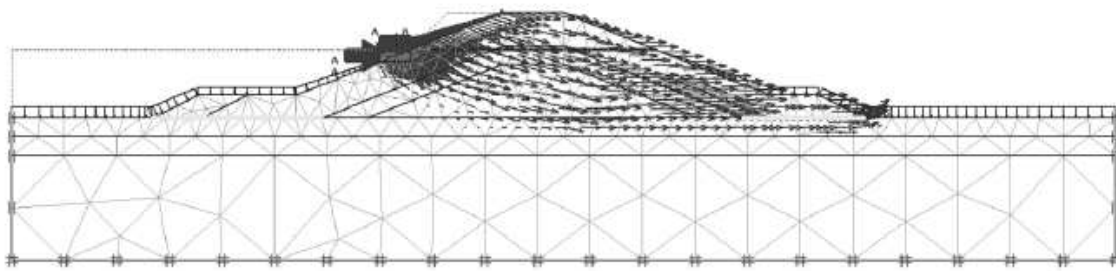

Figure 5.116

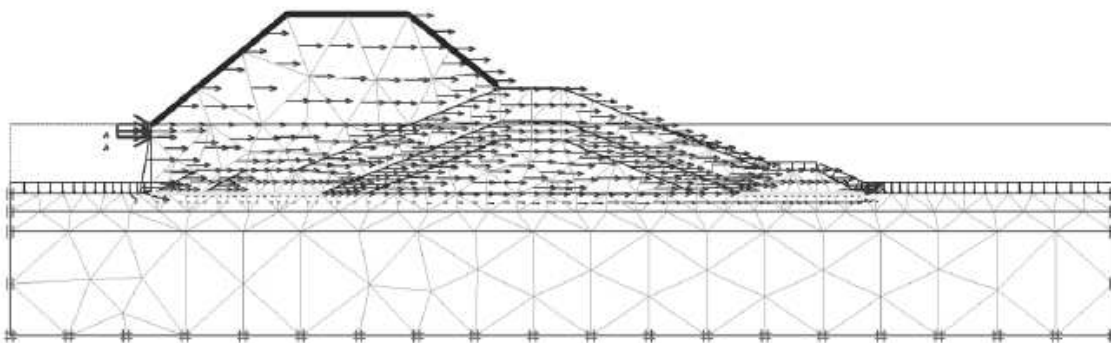
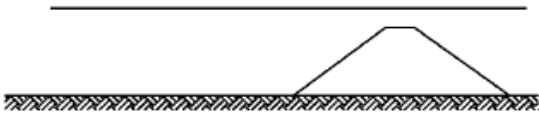
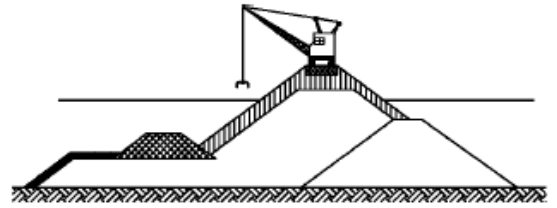

Figure 5.117



ULS  
 Erosion of unprotected materials under wave attack  
 Stability of slopes (particularly if top of structure can be above water)  
 Soil stability



ULS  
 Stability of slopes (attention should be paid to execution loads)  
 Stability of construction equipment  
 Soil stability

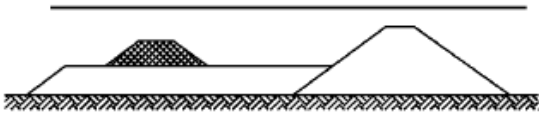

ULS  
 Erosion of unprotected materials under wave attack  
 Stability of slopes  
 Soil stability  
 Toe erosion

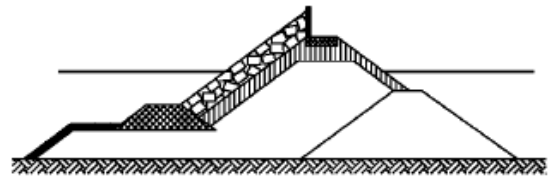

ULS  
 Sliding of the armour  
 Stability of slopes  
 Soil stability

SLS  
 Settlement

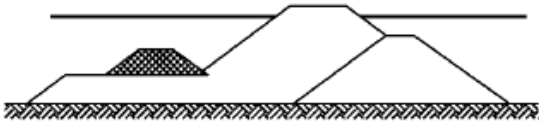

ULS  
 Erosion of unprotected outer slope (and inner slope in case of wave overtopping)  
 Stability of slopes  
 Soil stability  
 Toe erosion

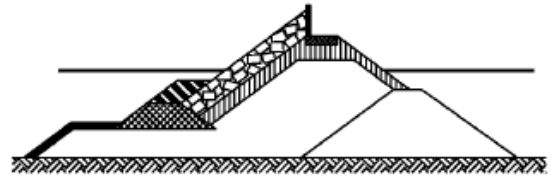

ULS  
 Stability of slopes  
 Soil stability

SLS  
 Settlement  
 Deformation

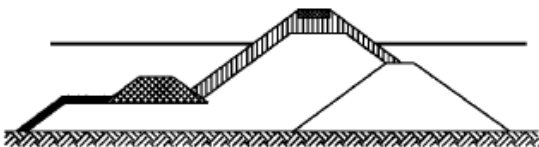

ULS  
 Erosion of the armour and filter layers  
 Stability of slopes  
 Soil stability

Figure 5.123

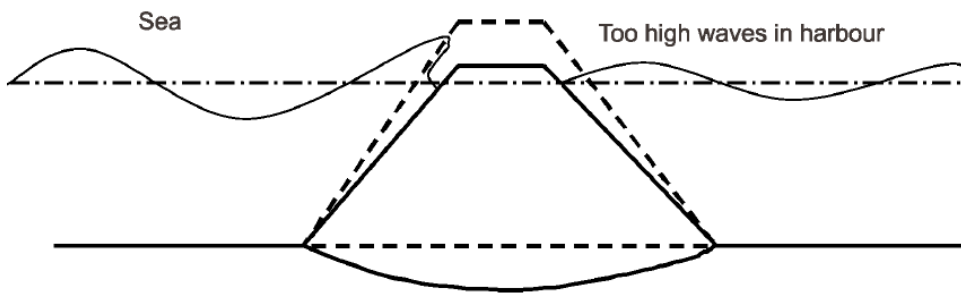

Figure 5.124

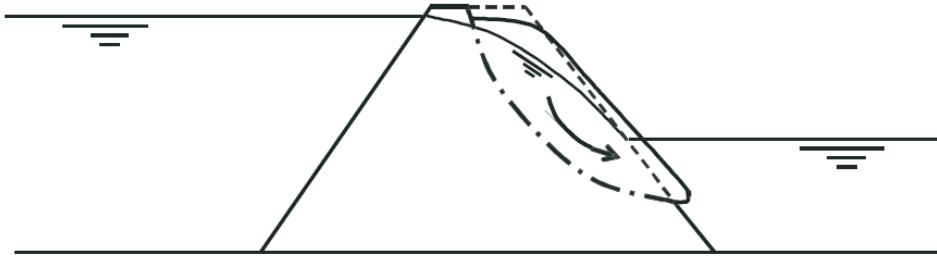
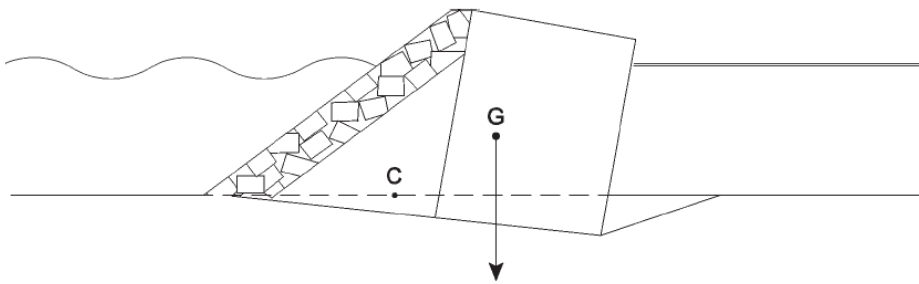

Figure 5.125



C : Centre of the foundation  
G : Centre of gravity

Figure 5.126

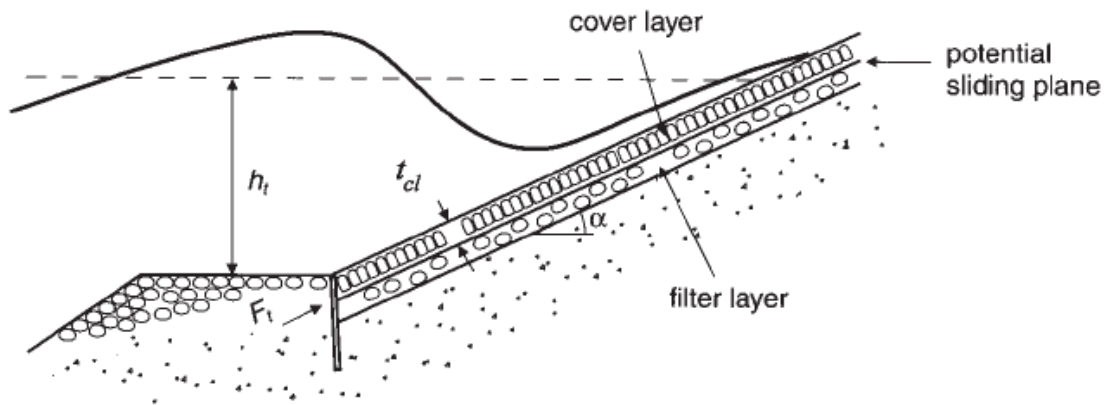

Figure 5.127

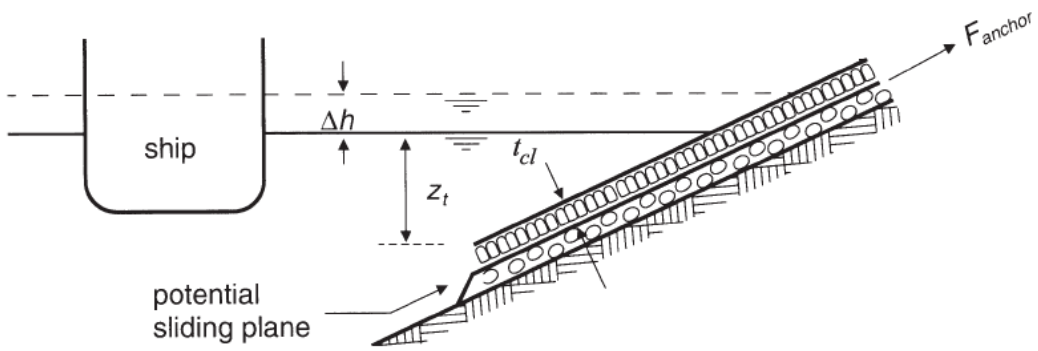

Figure 5.128

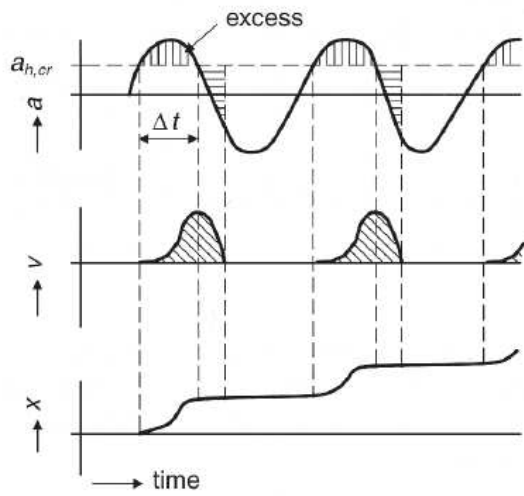

Figure 5.132

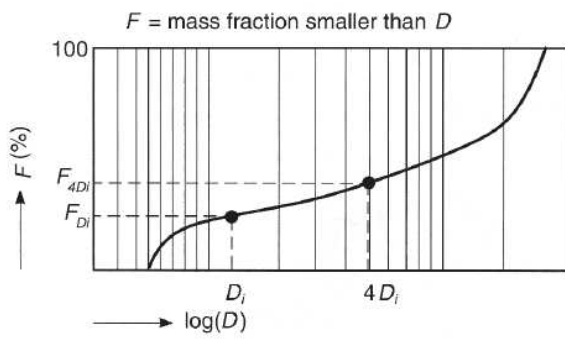

Figure 5.133

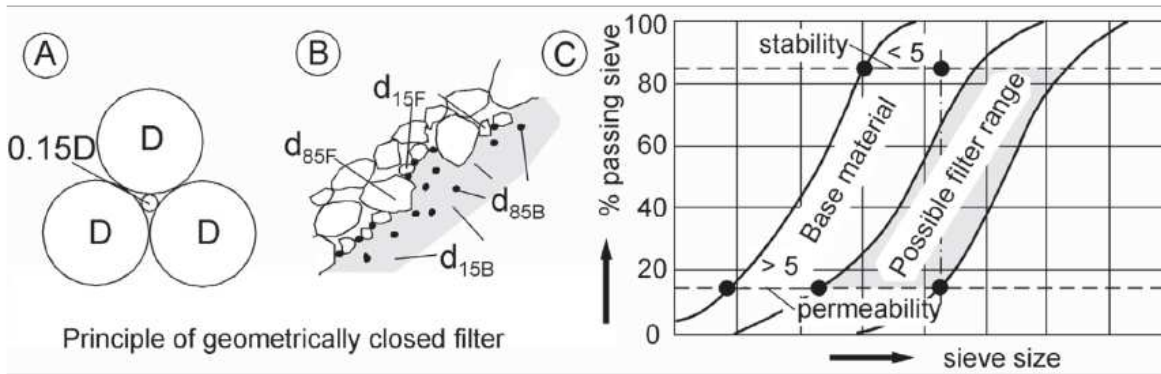

Figure 5.134

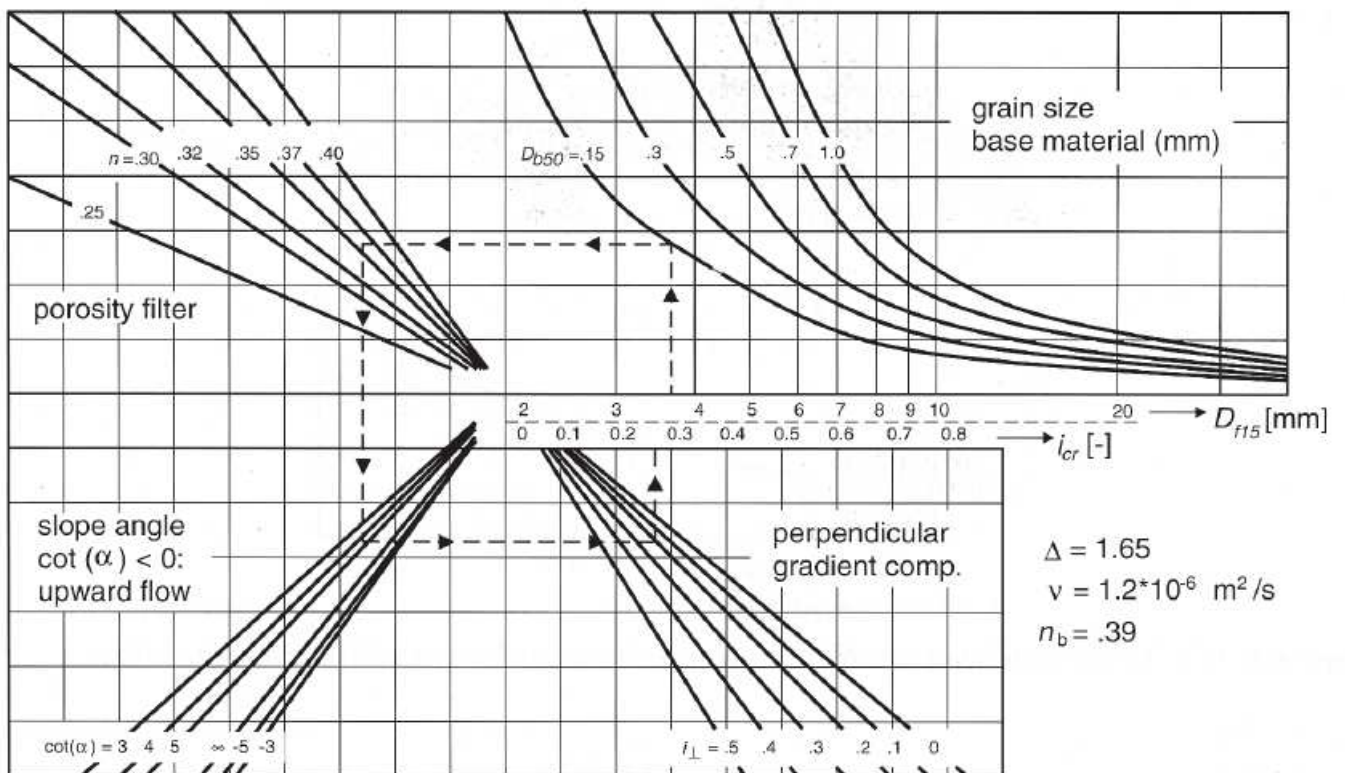

Figure 5.135



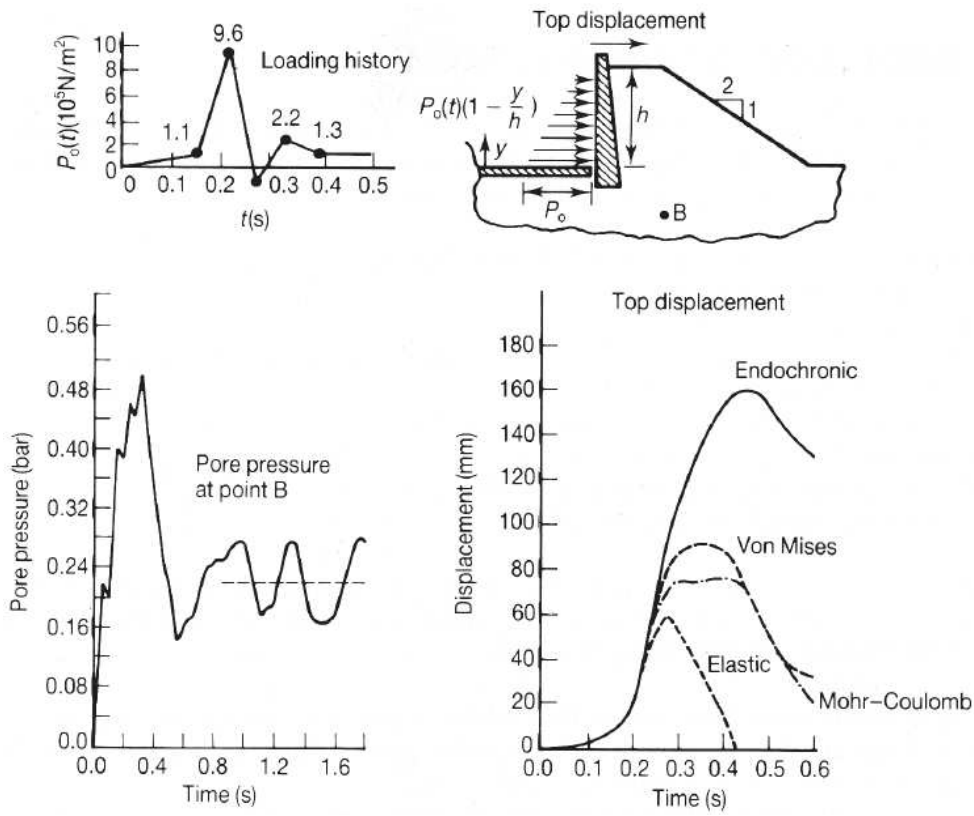

Figure 5.137

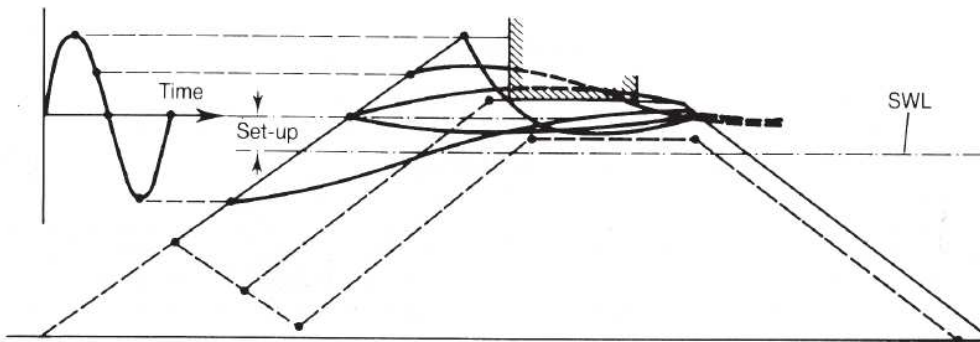
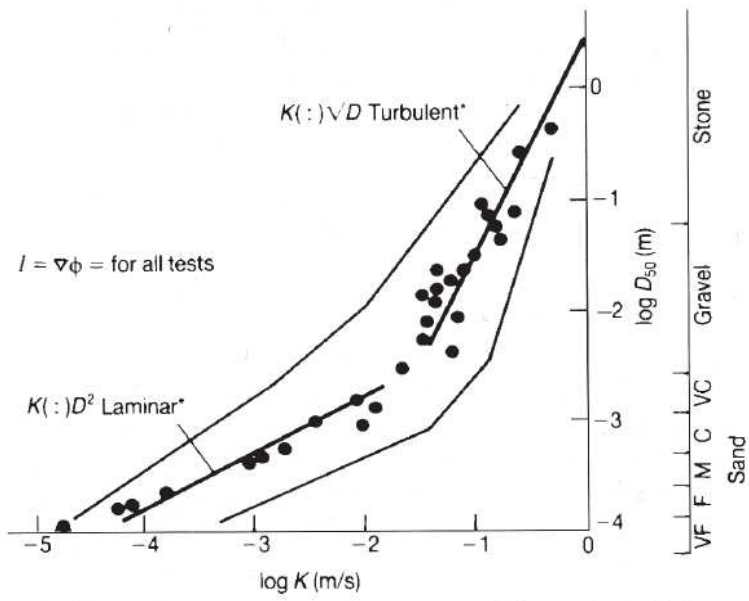

Figure 5.138



\*Refers to porous flow regime in which permeability ( $K$ ) – grain size ( $D_{50}$ ) relation has been measured.

Figure 5.139

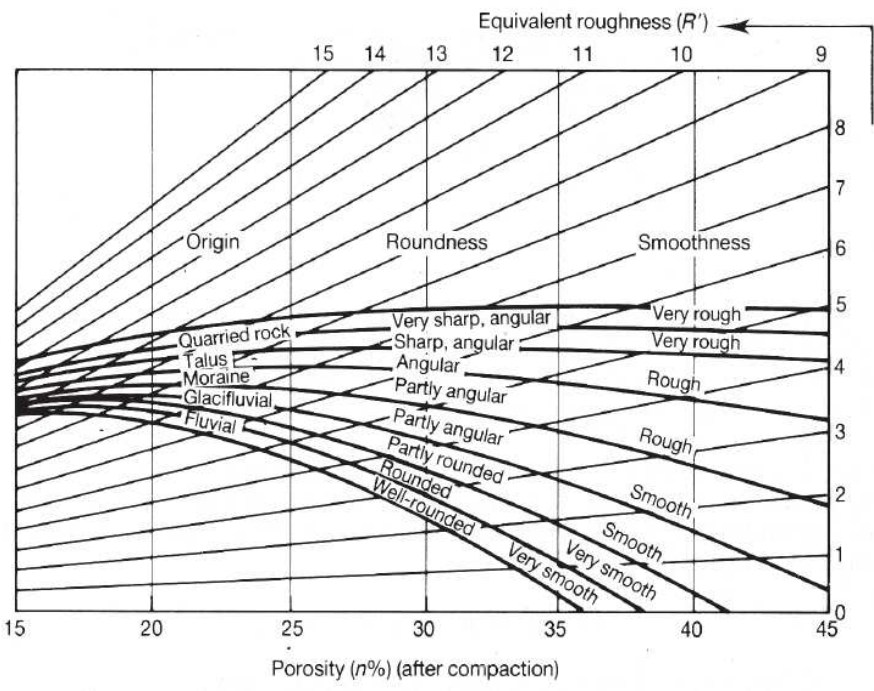

Figure 5.140

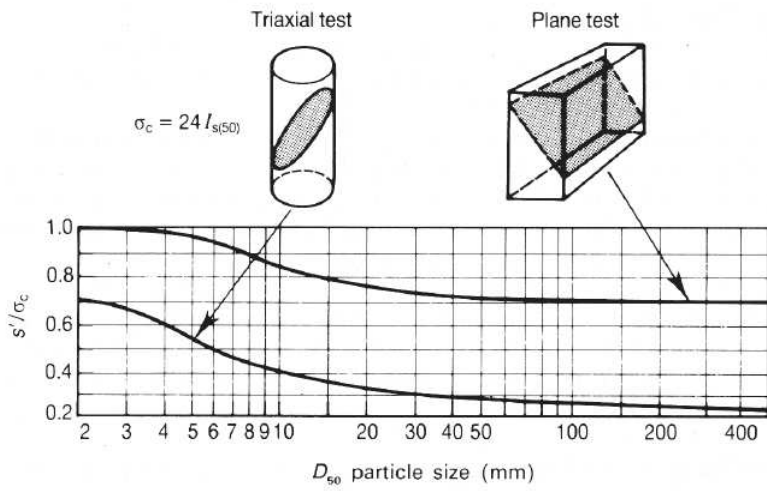

Figure 5.141

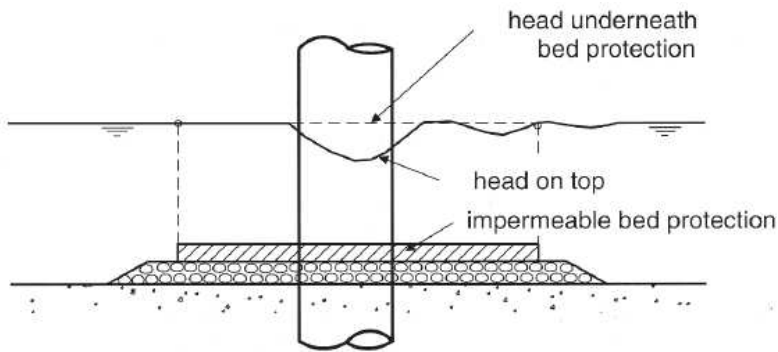

Figure 5.145

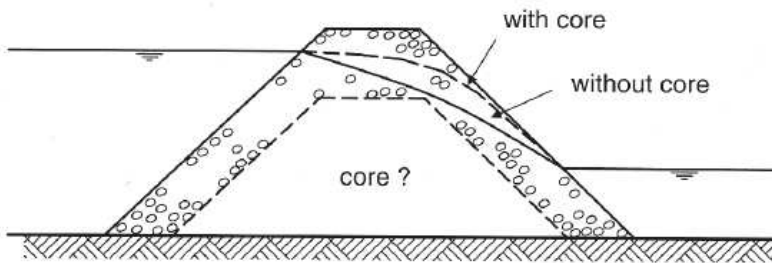

Figure 5.146

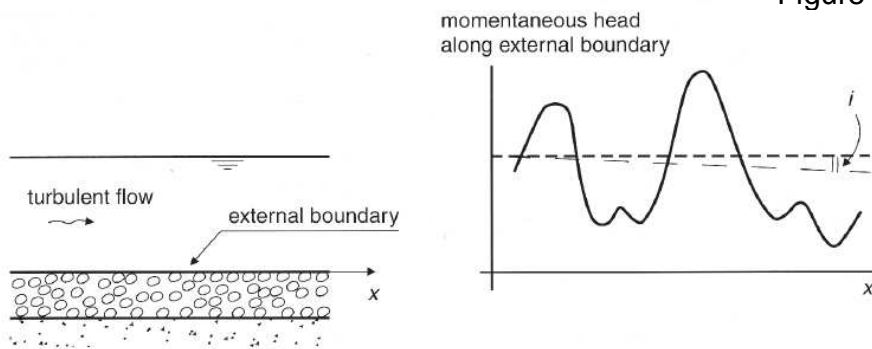

Figure 5.150

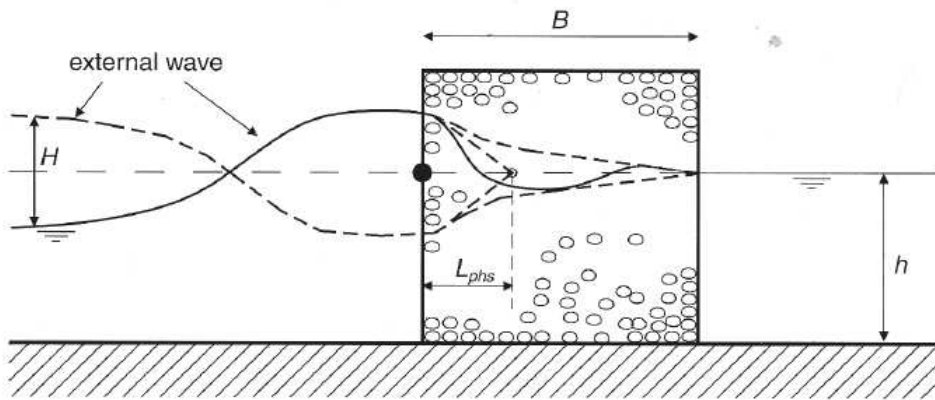

Figure 5.151

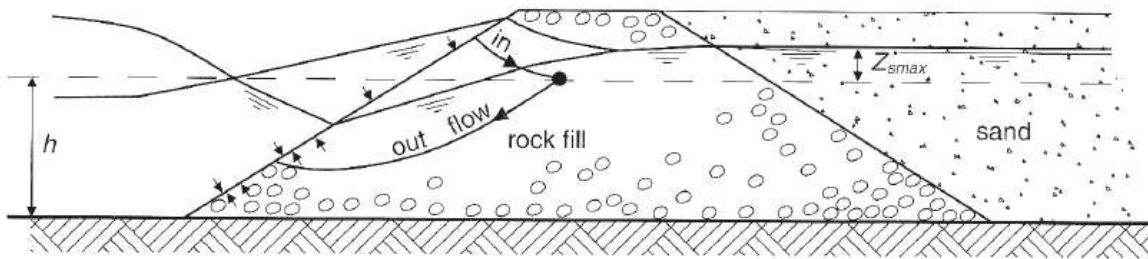

Figure 5.153

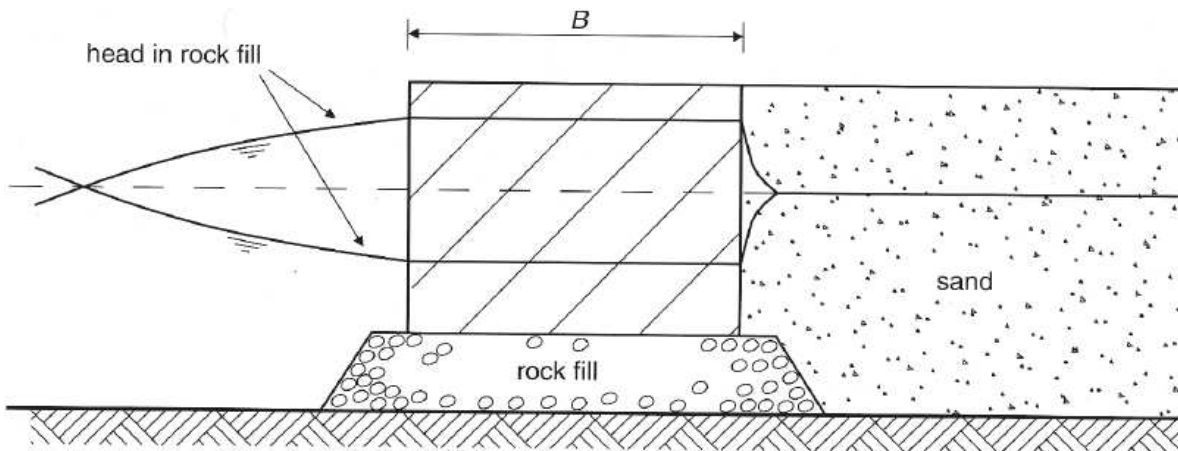

Figure 5.154

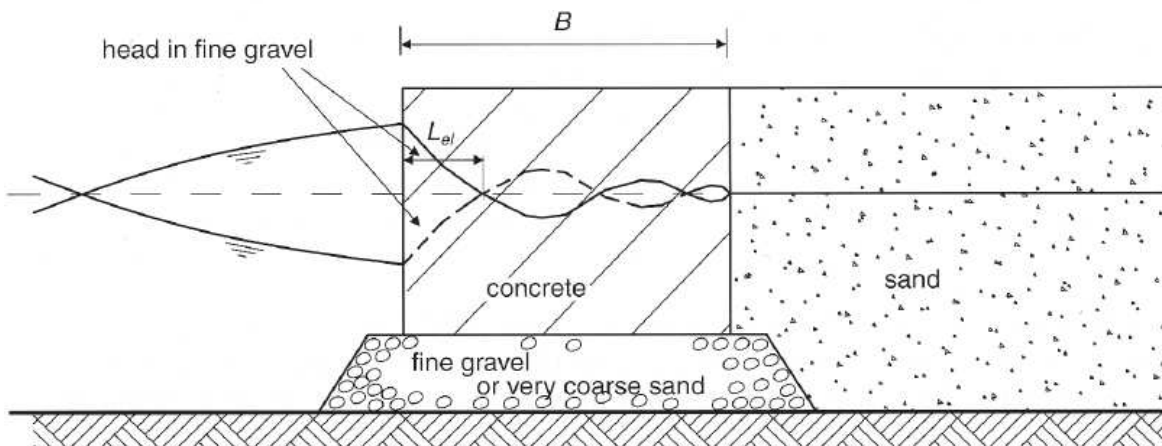

Figure 5.155

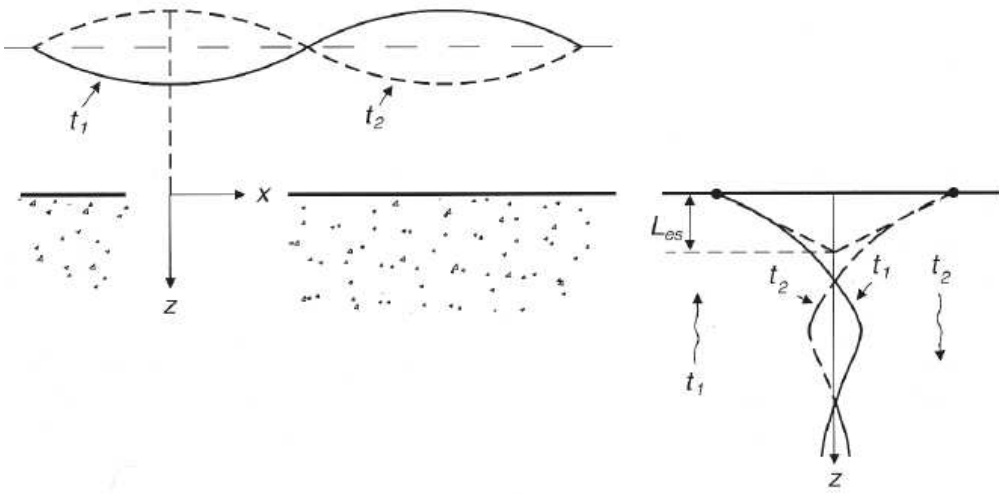

Figure 5.156

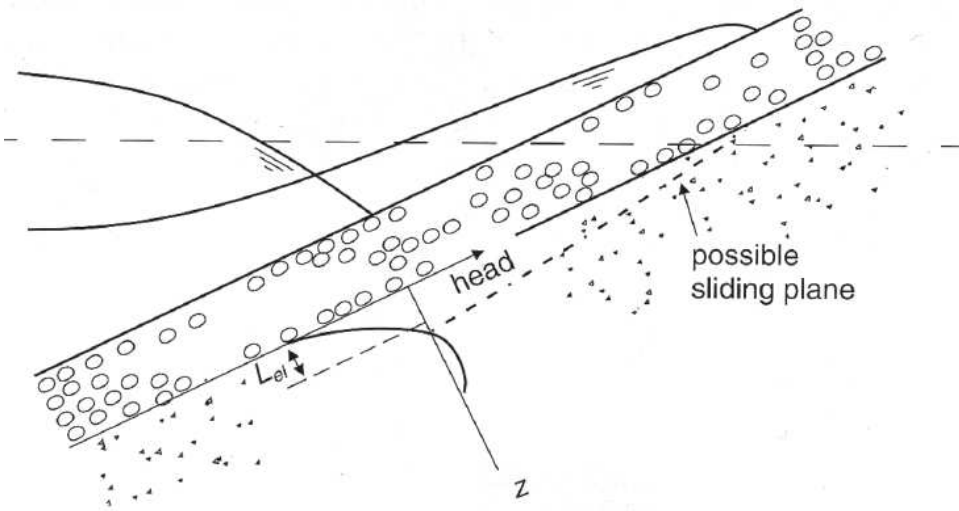

Figure 5.157

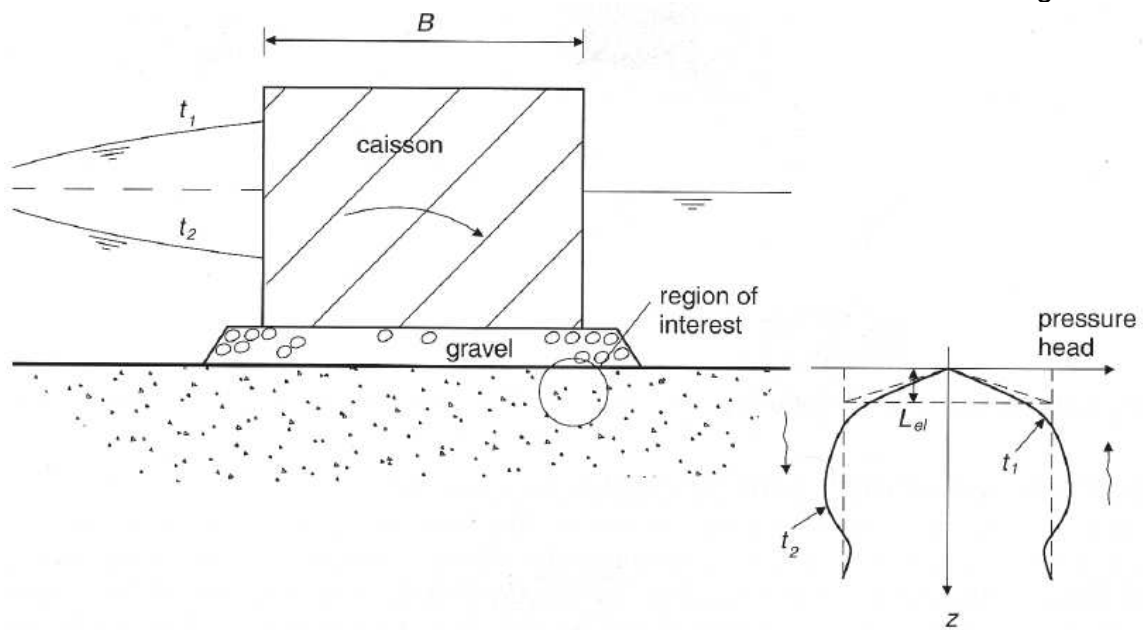

Figure 5.158

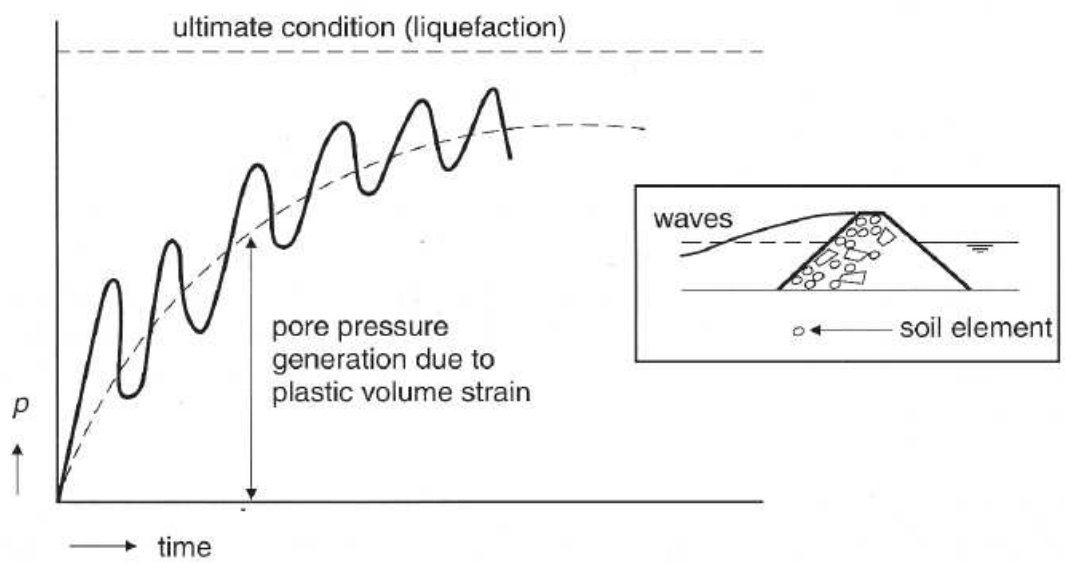

Figure 5.159

Figures from Chapter 6:

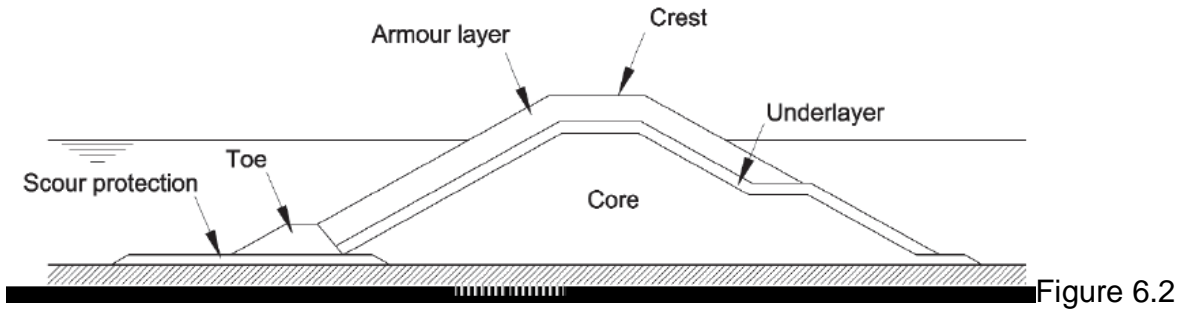

Figure 6.2

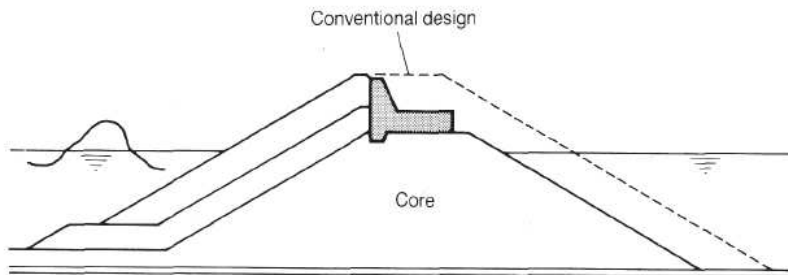

Figure 6.23

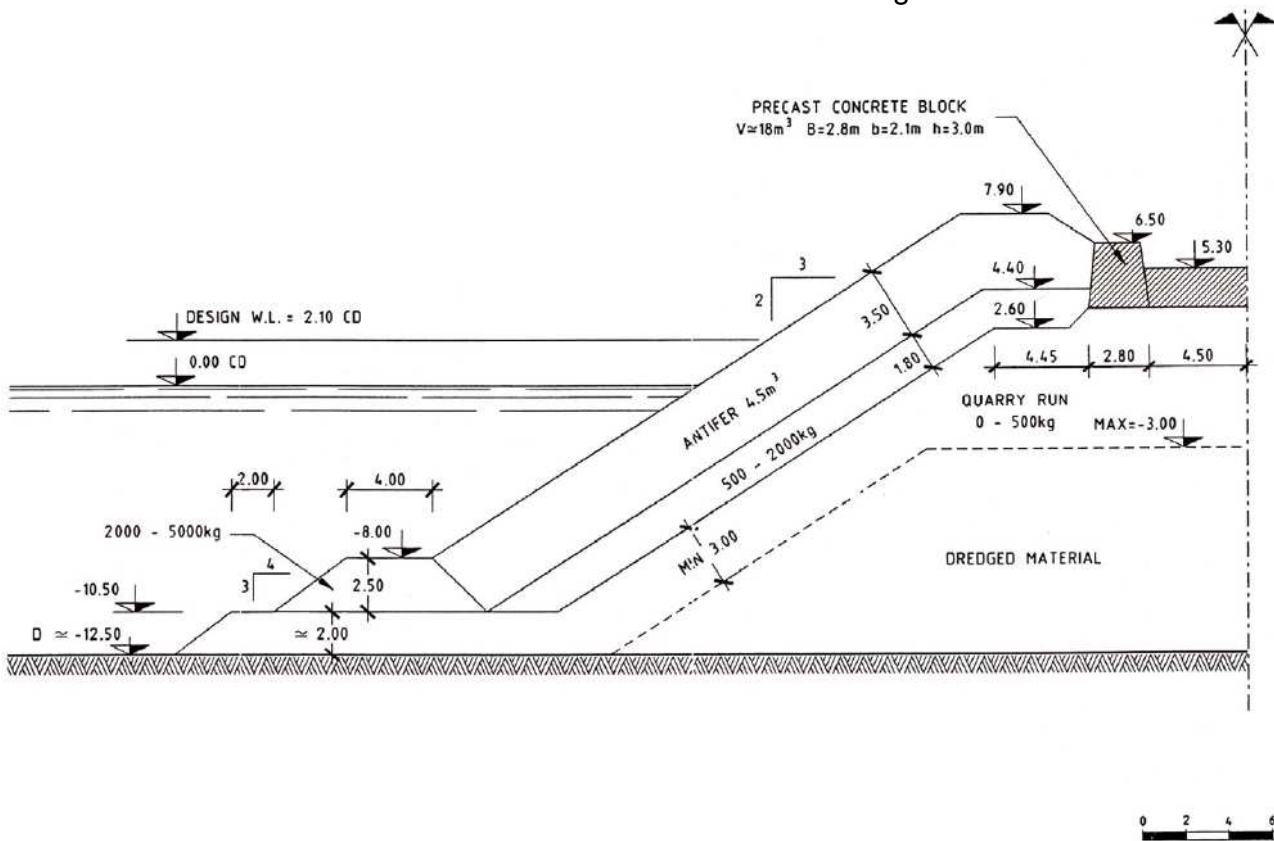

Figure 6.27

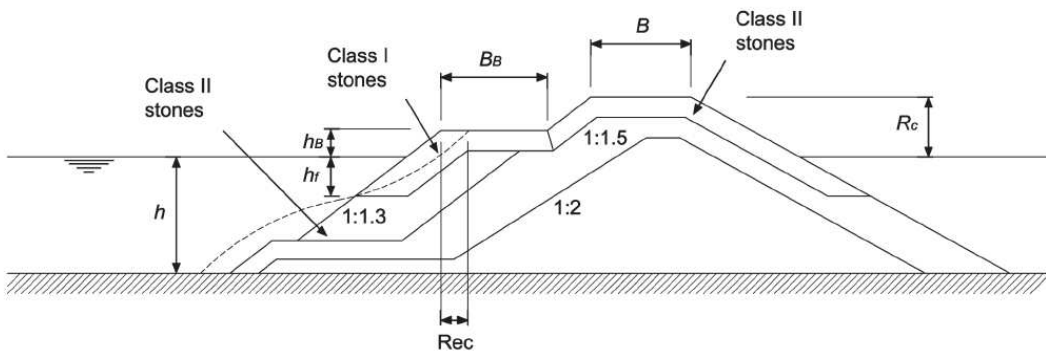

Figure 6.29

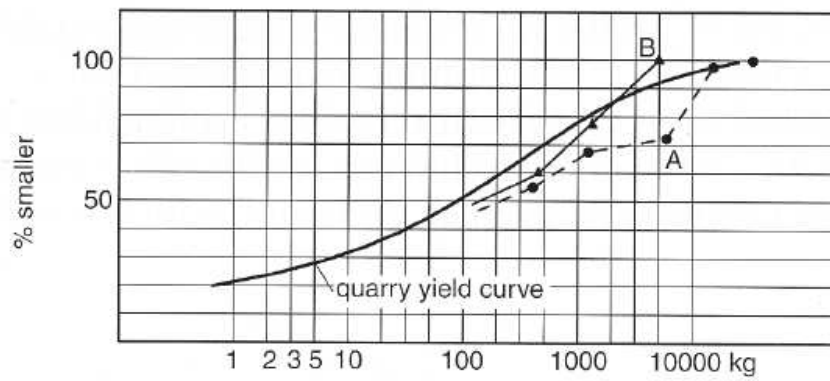
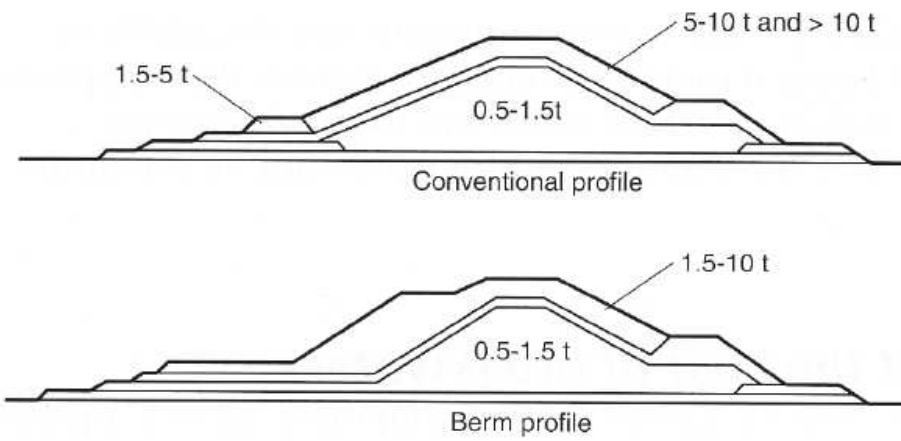
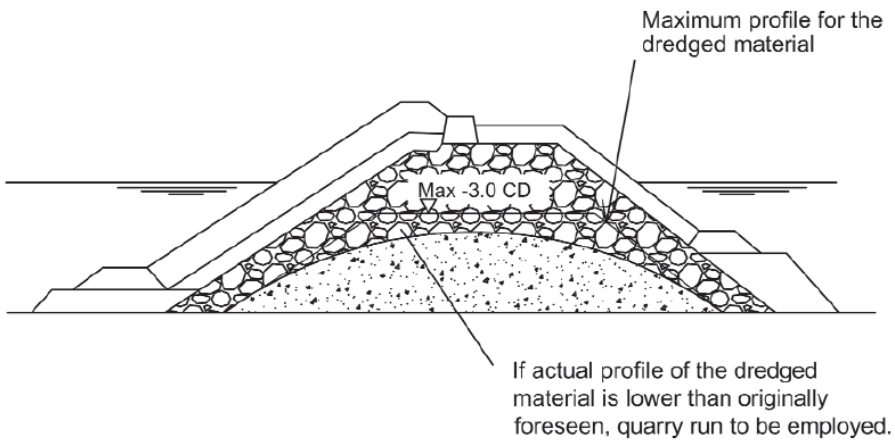
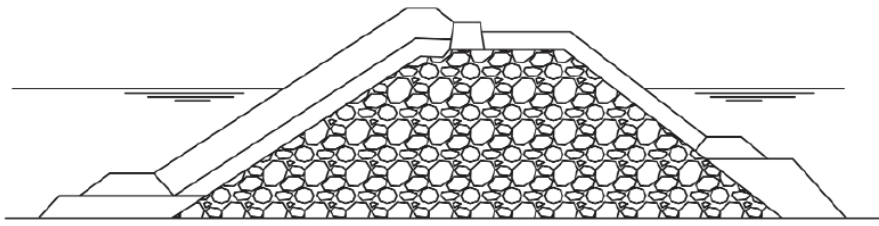

Figure 6.34





LEGEND



QUARRY RUN



DREDGED MATERIAL

Figure 6.35

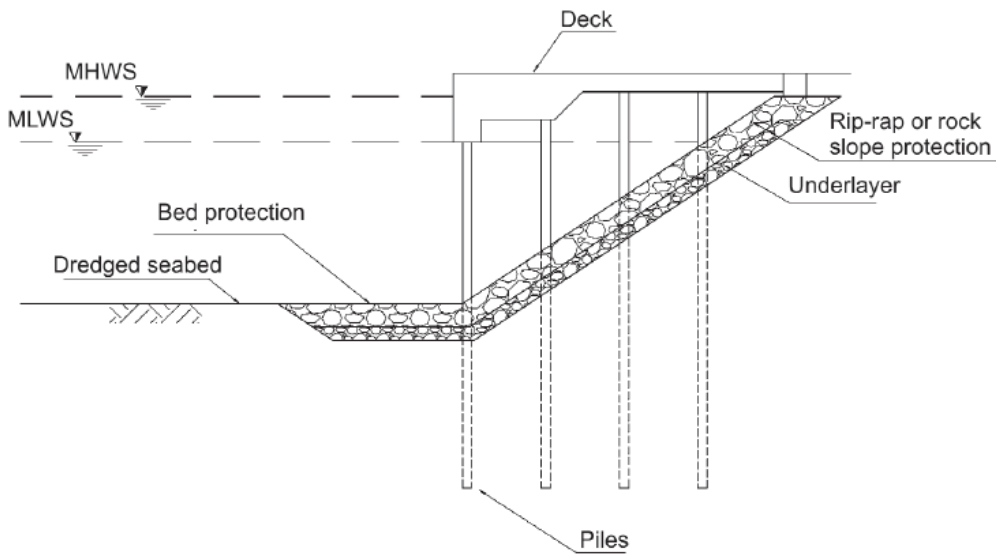

Figure 6.38

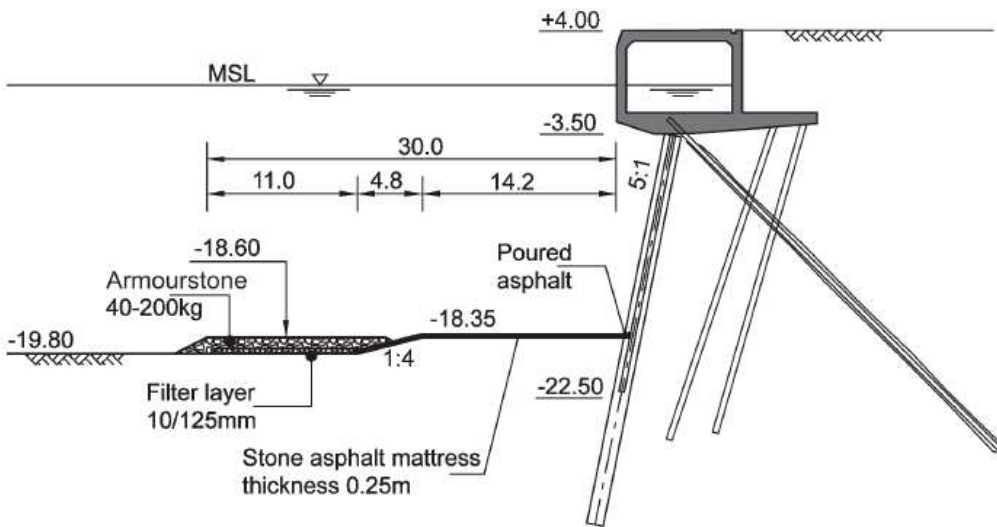

Figure 6.39

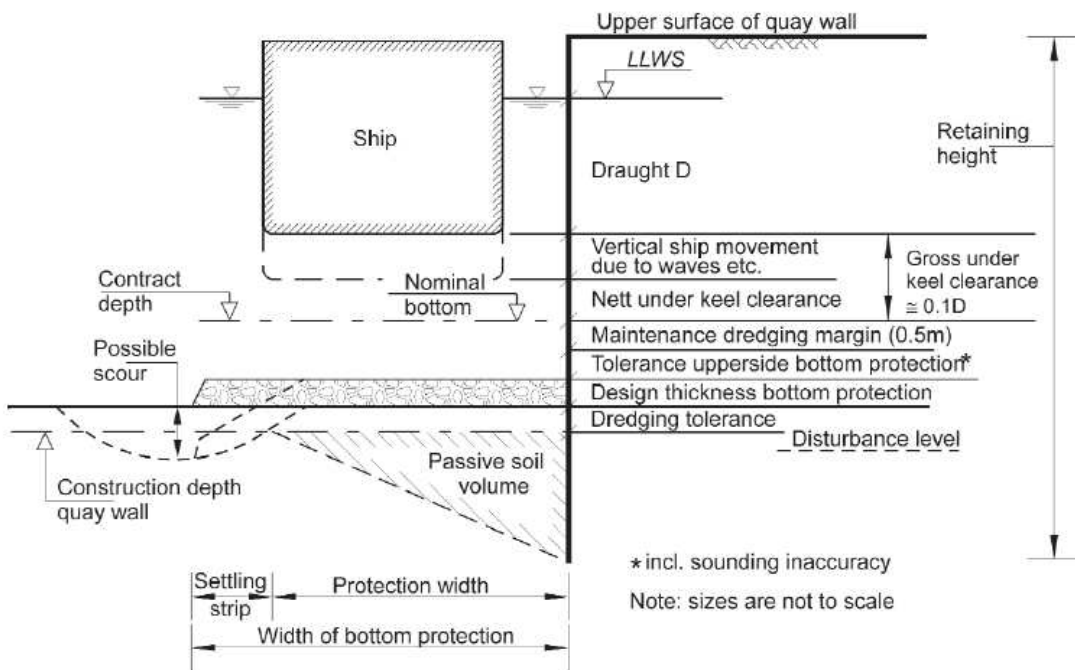
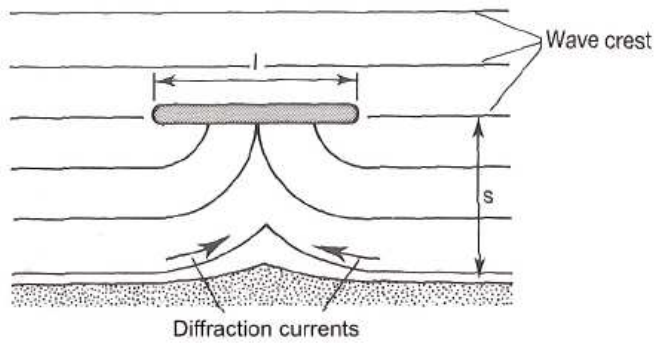
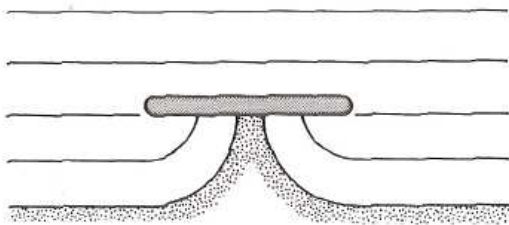

Figure 6.40



Development of depositional feature behind offshore breakwater,  $l/s < 2$ , salient formed



Equilibrium depositional feature behind offshore breakwater,  $l/s > 2$ , tombolo formed

Figure 6.51

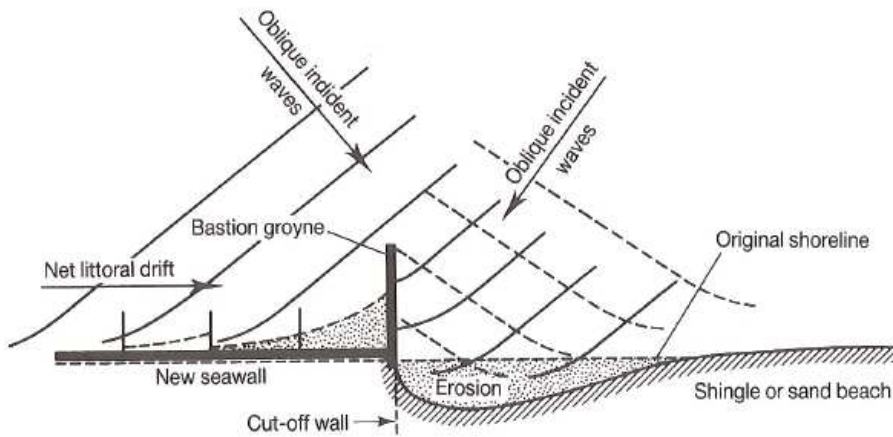

Figure 6.67

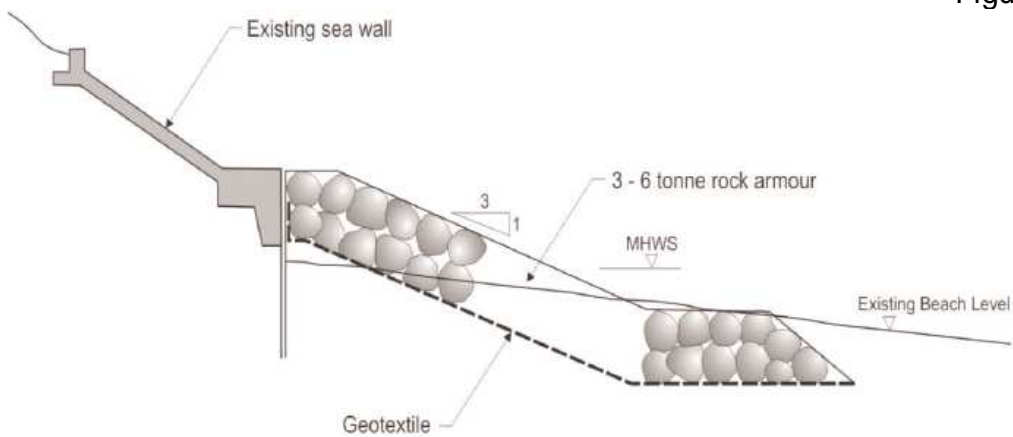

Figure 6.70

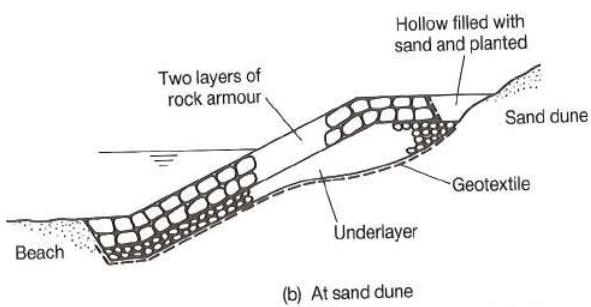
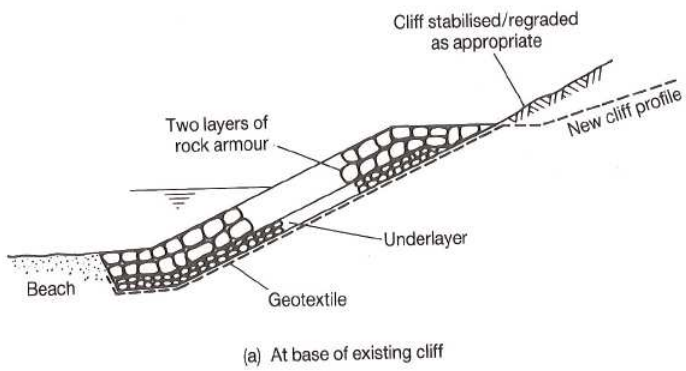

Figure 6.72

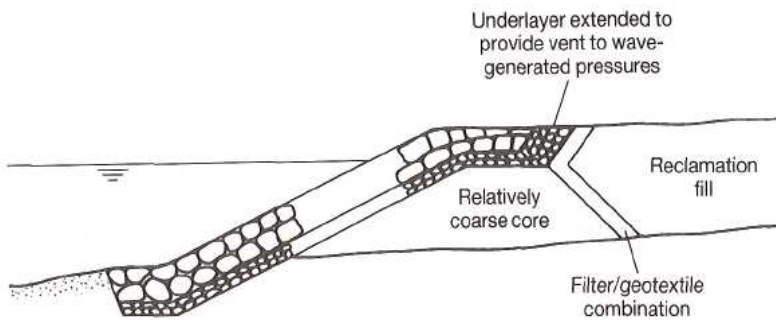

Figure 6.74

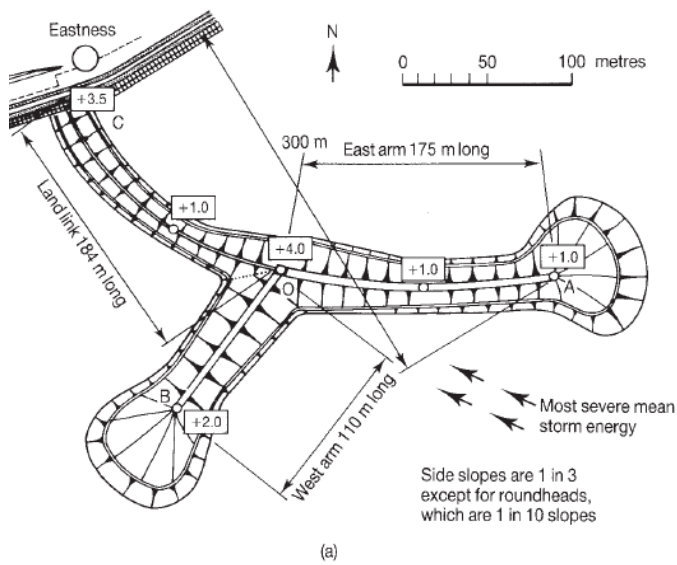

Figure 6.78

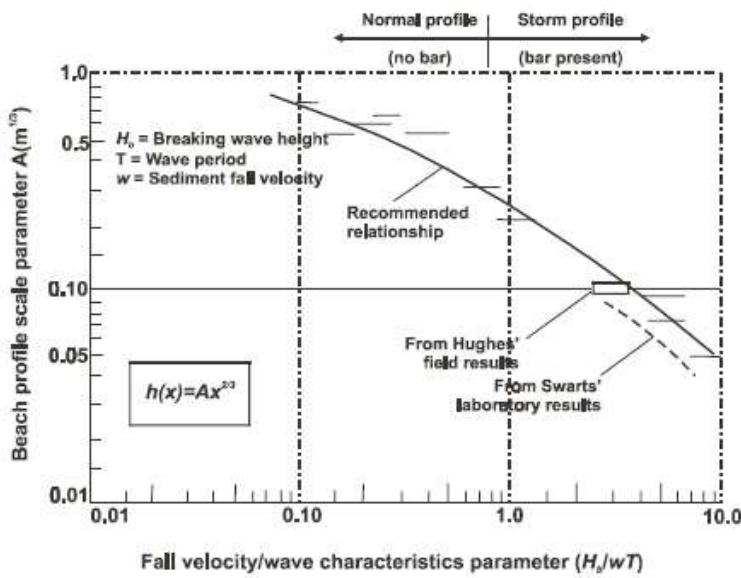
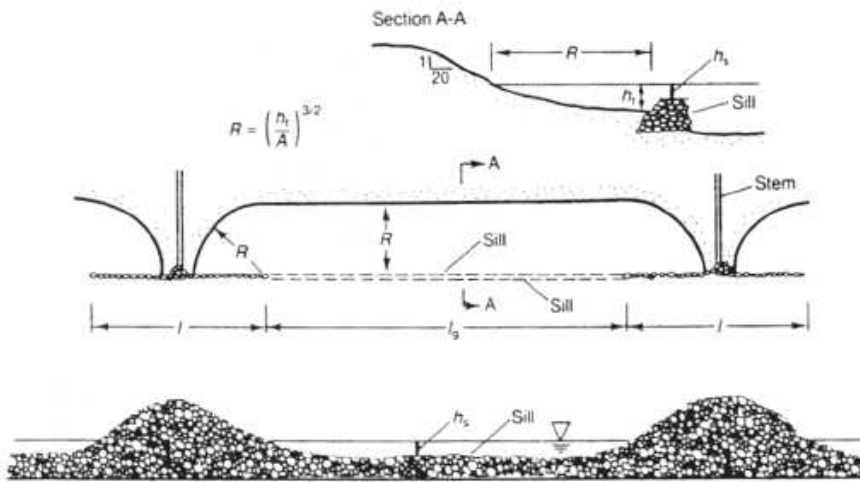

Figure 6.80

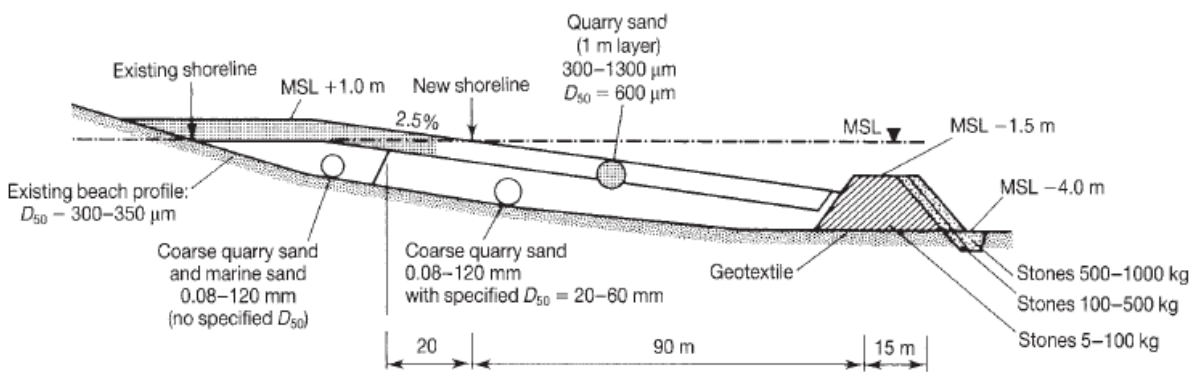

Figure 6.81

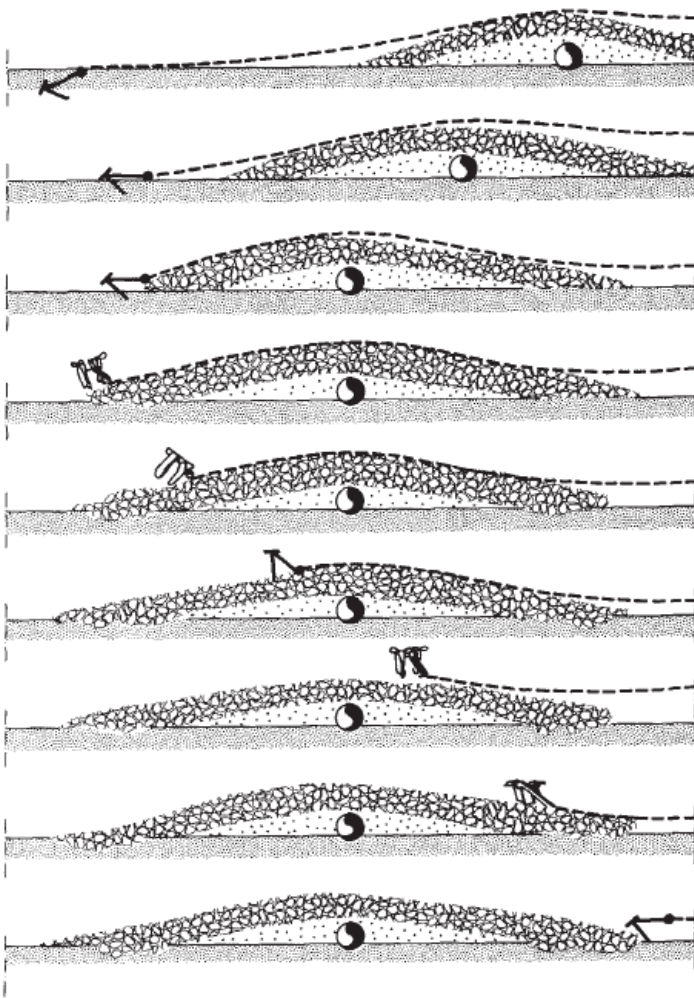

Figure 6.85

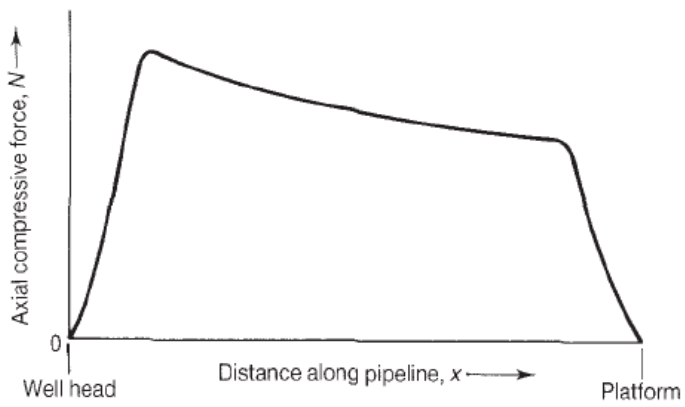

Figure 6.86

Figures from Chapter 7:

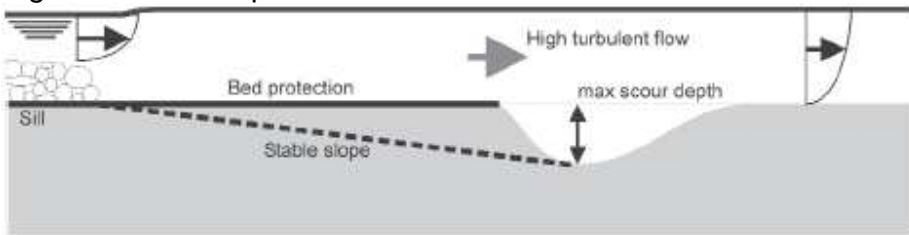

Figure 7.10

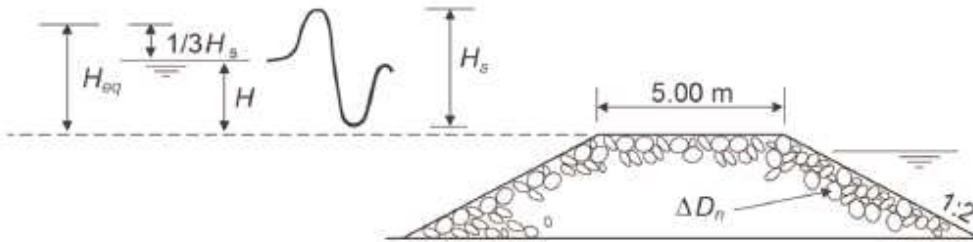
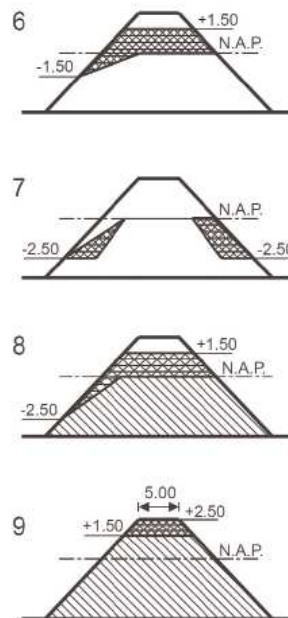
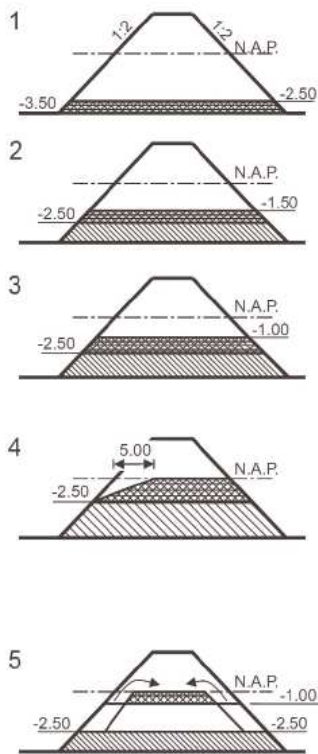
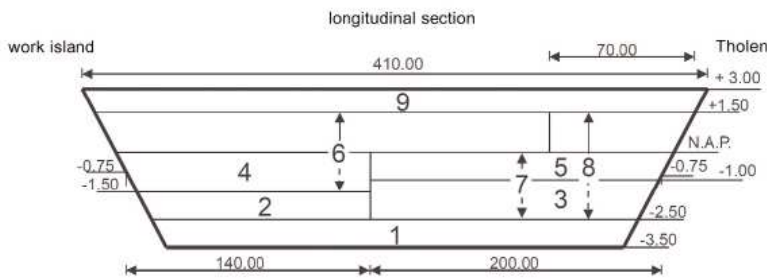

Figure 7.13



armourstone 300-1000 kg

Figure 7.14

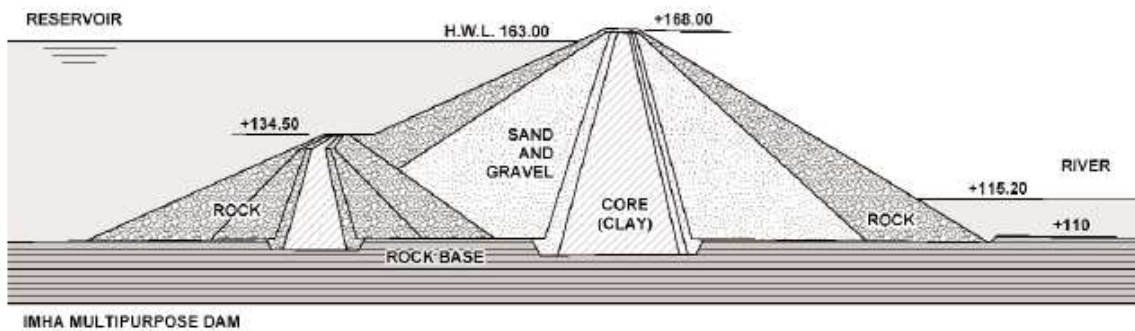

Figure 7.26

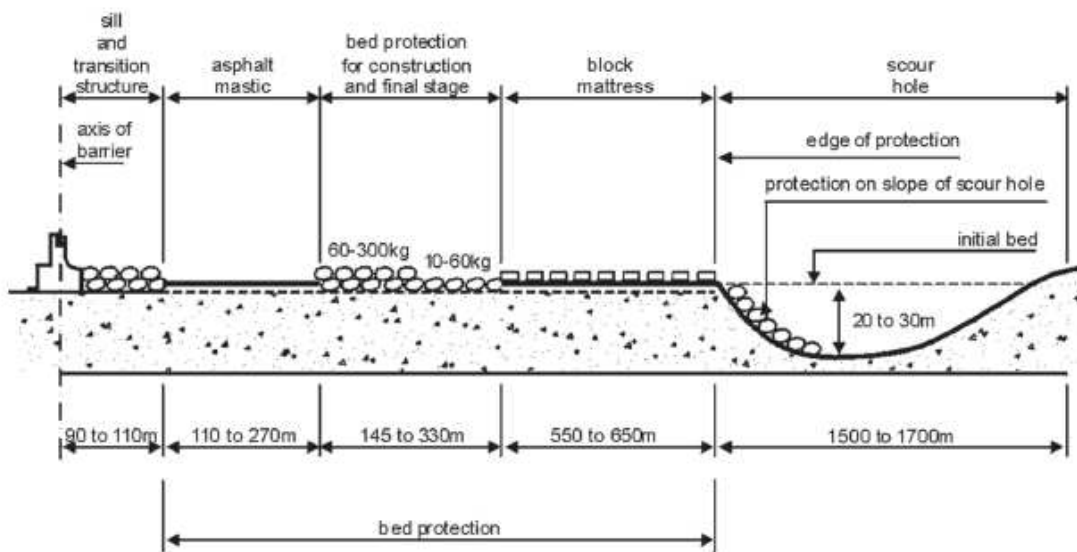

Figure 7.27



Figures of Chapter 8:

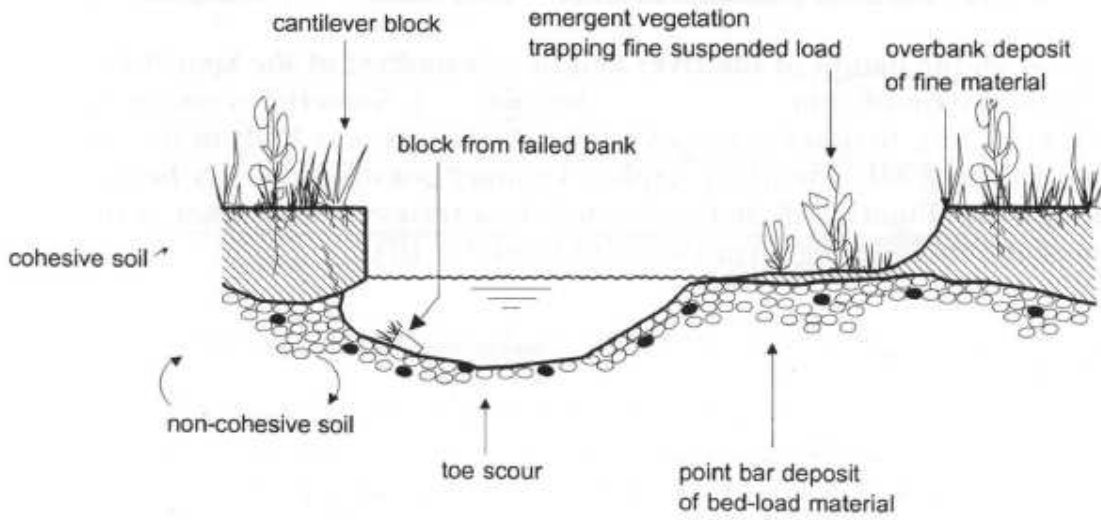

Figure 8.8

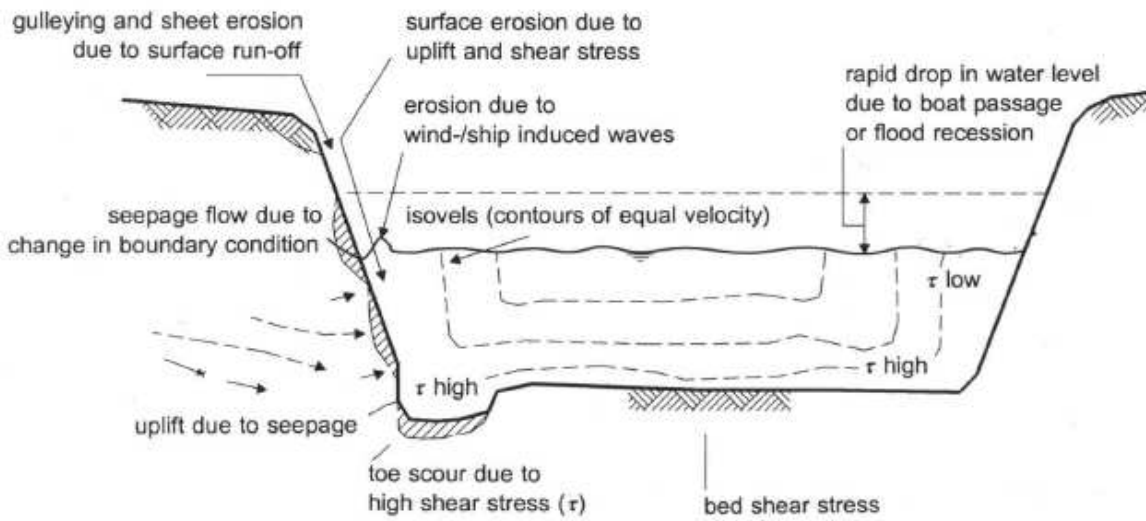

Figure 8.9

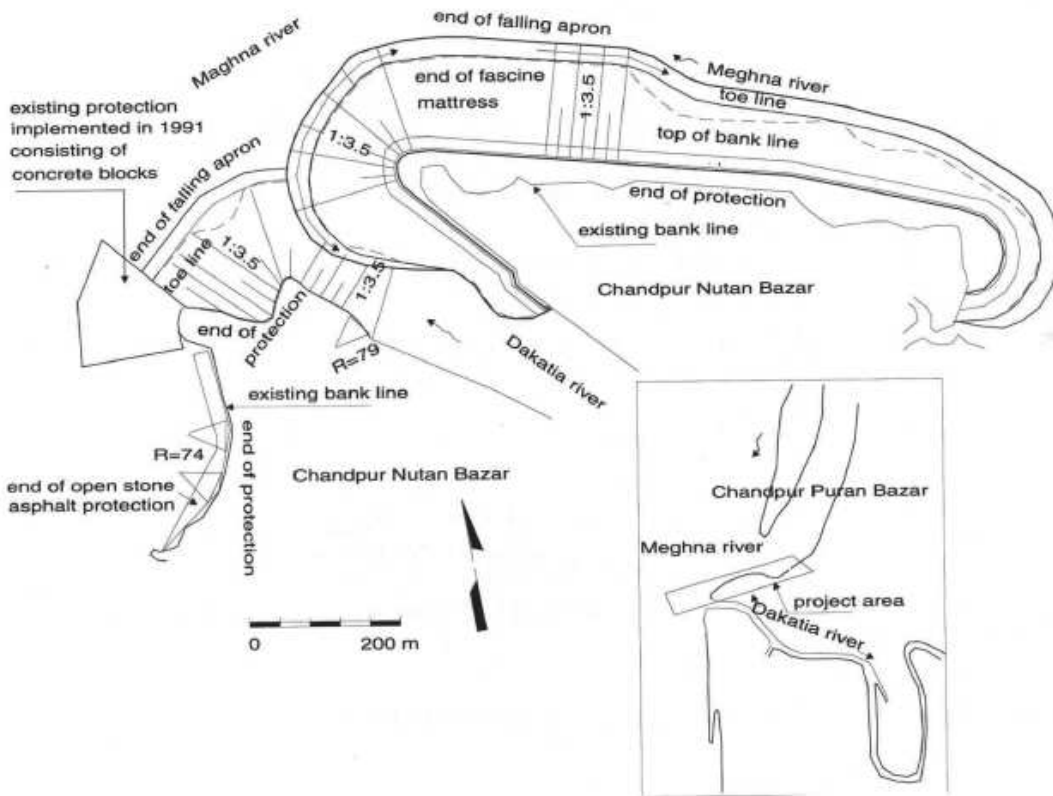

Figure 8.15

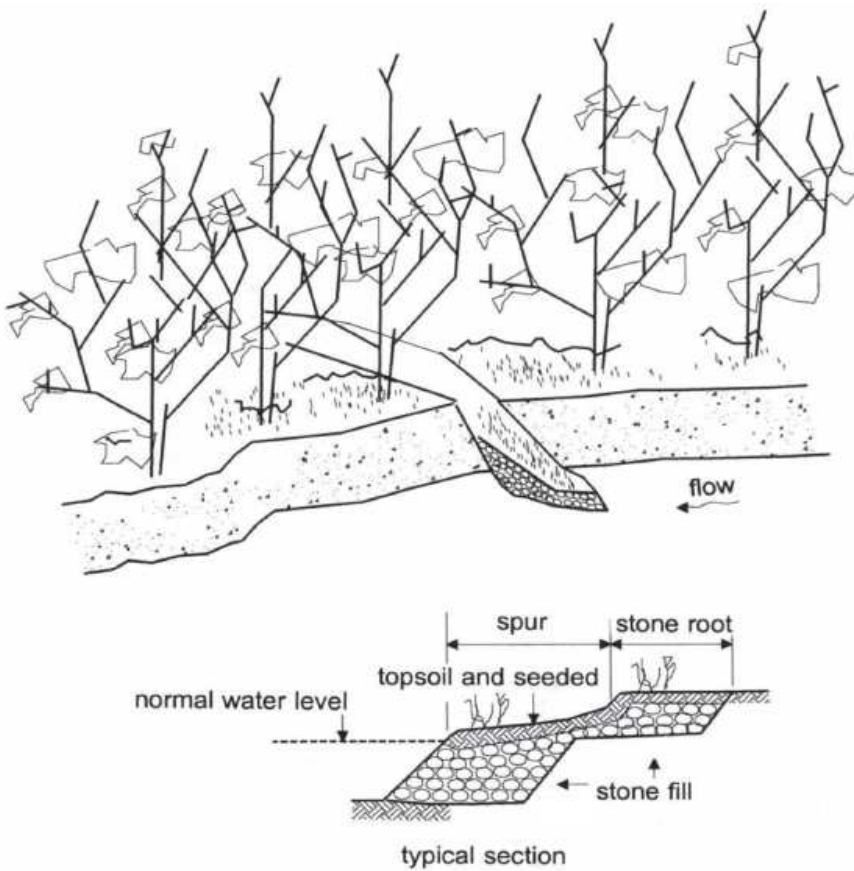

Figure 8.16

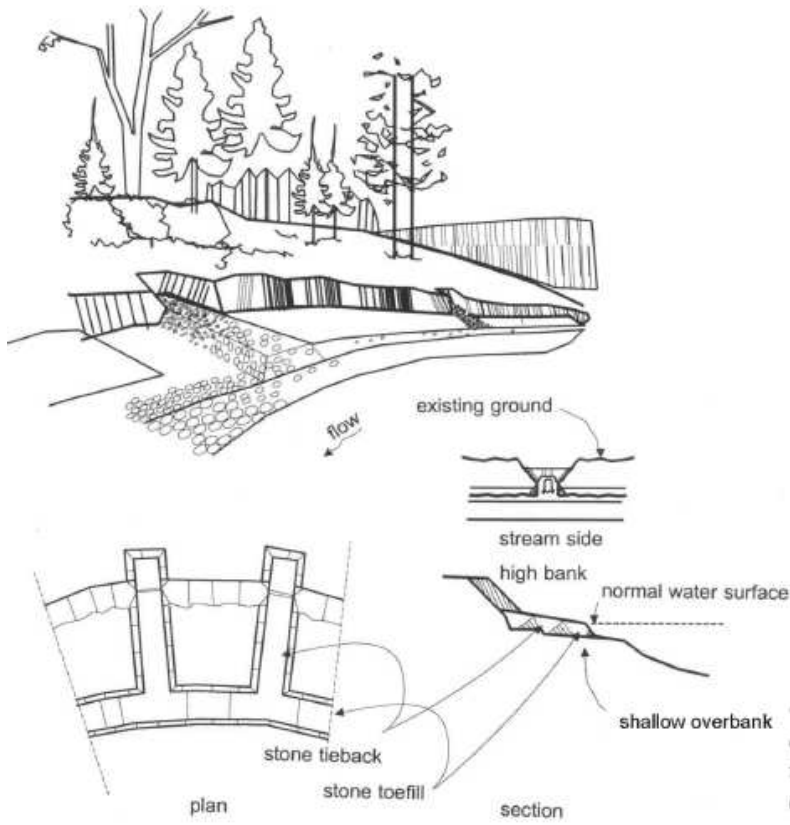

Figure 8.19

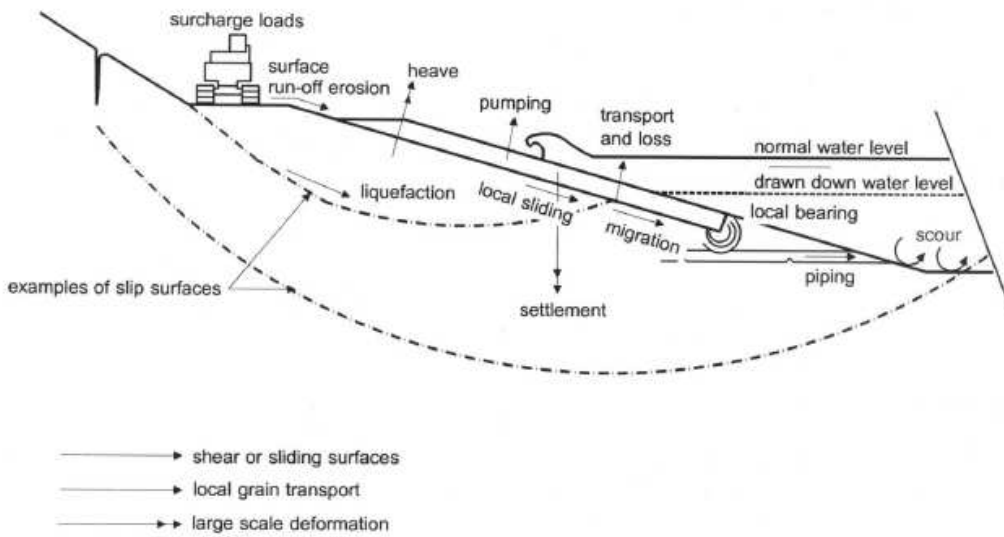
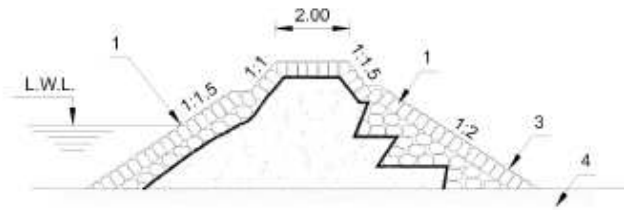
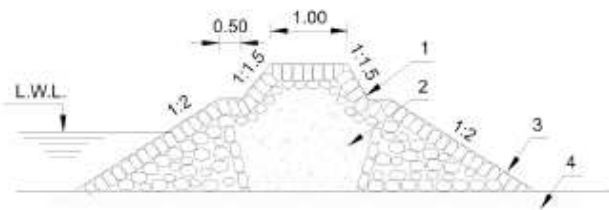

Figure 8.22



(a) High spur or longitudinal dike



(b) High spur or longitudinal dike

- 1 Cover layer (loose, pitched or grouted stones)
- 2 Gravel
- 3 Rip-rap
- 4 Sub-soil or coarse-broken stone

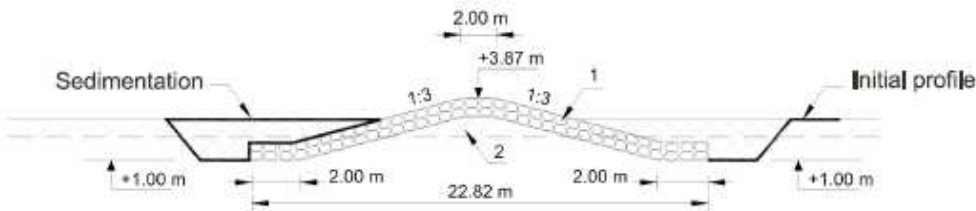

(c) Low spur-dike

Figure 8.23

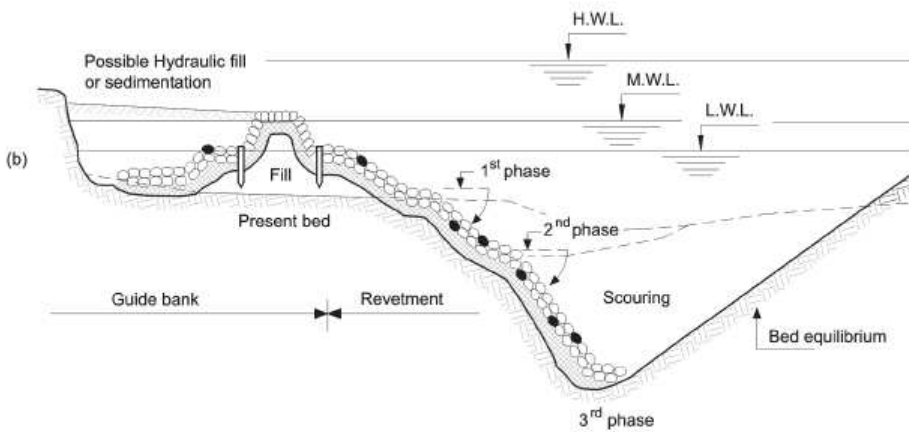
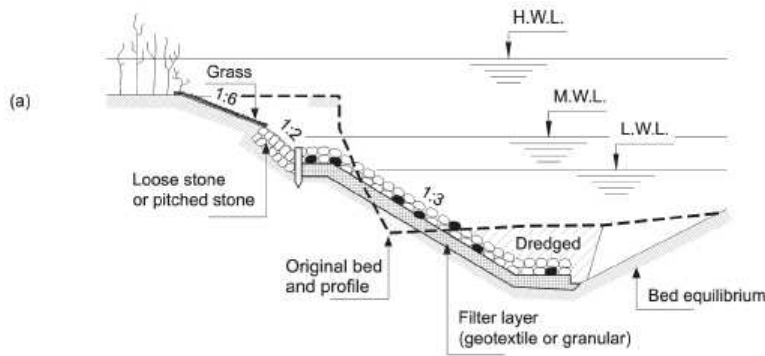

Figure 8.24

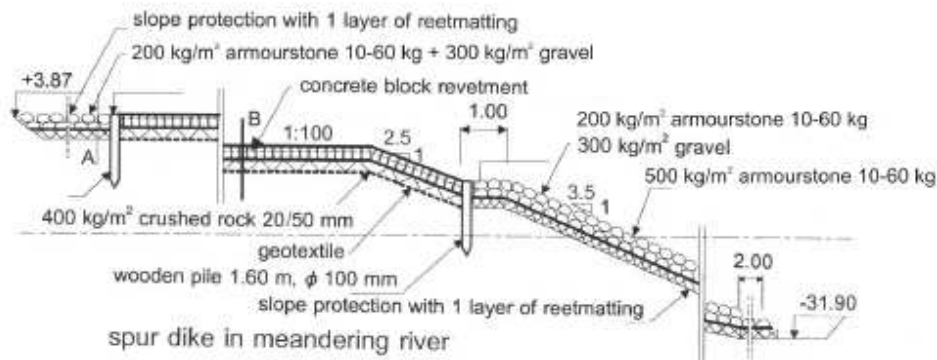
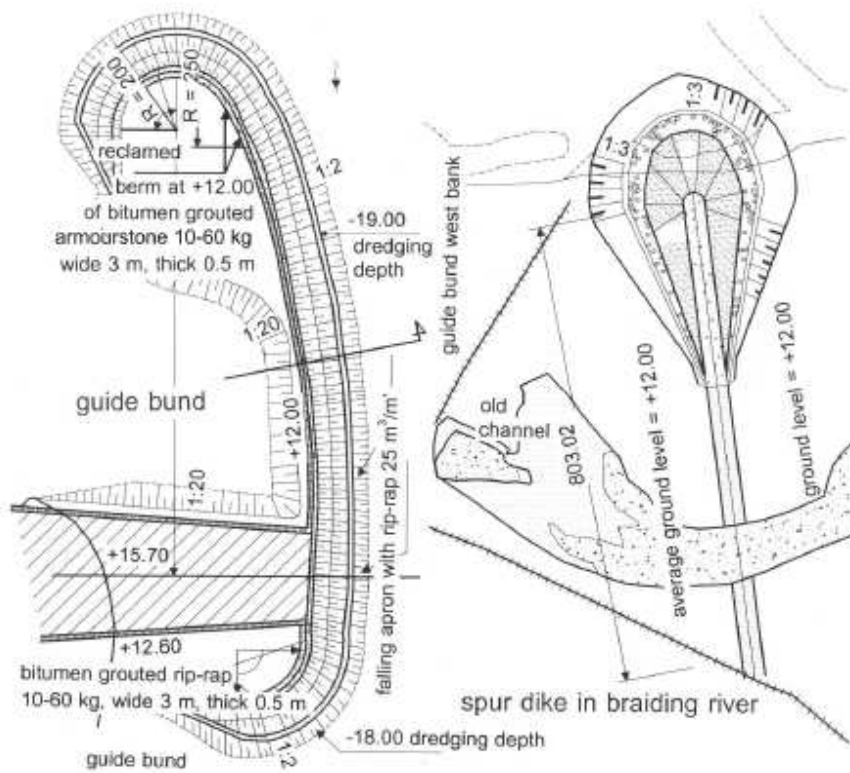

Figure 8.25

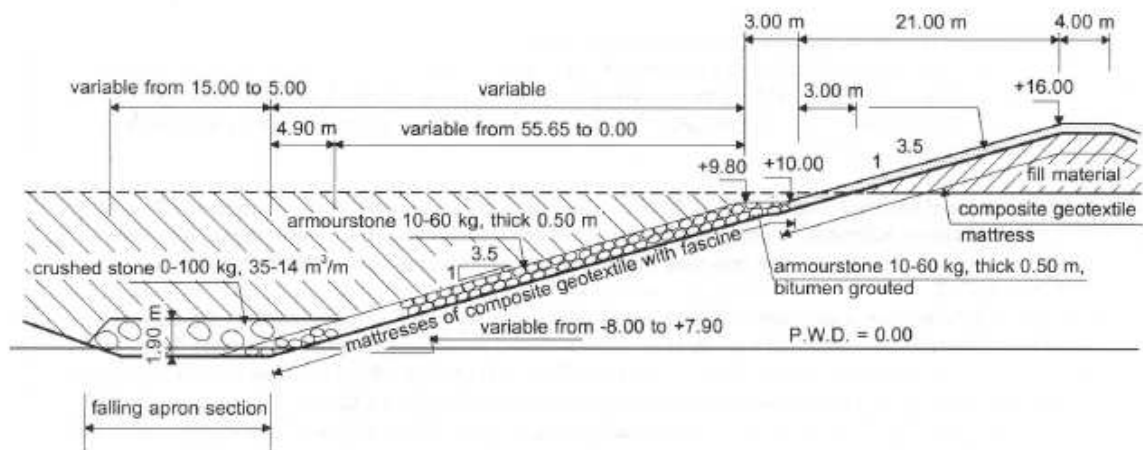

Figure 8.27

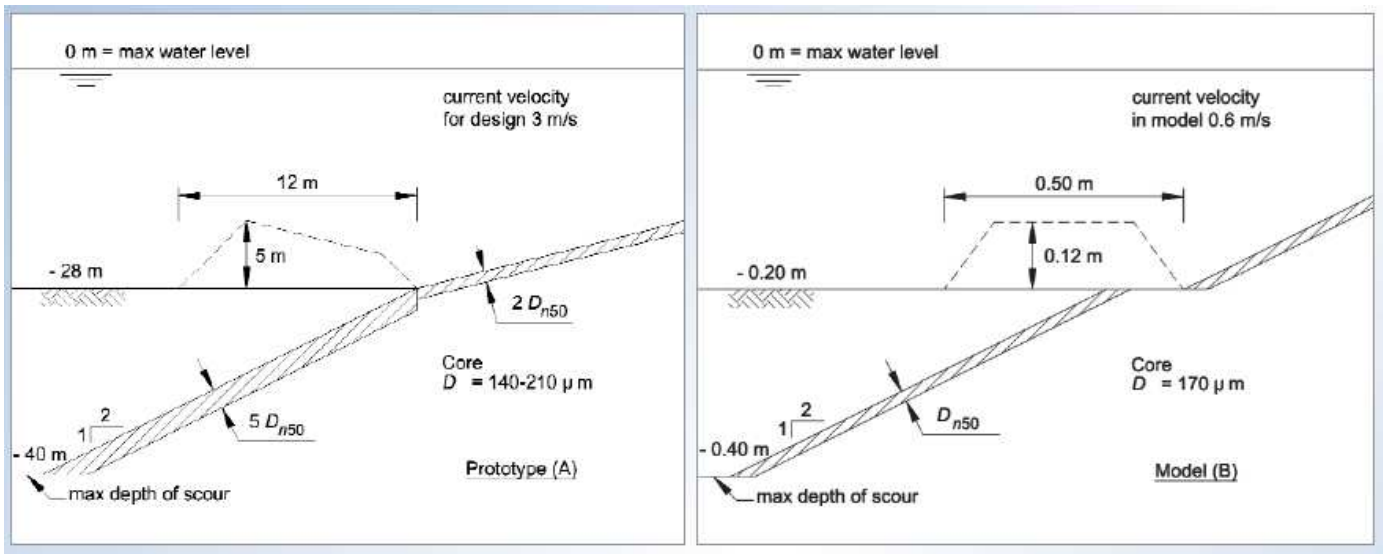

Figure 8.28

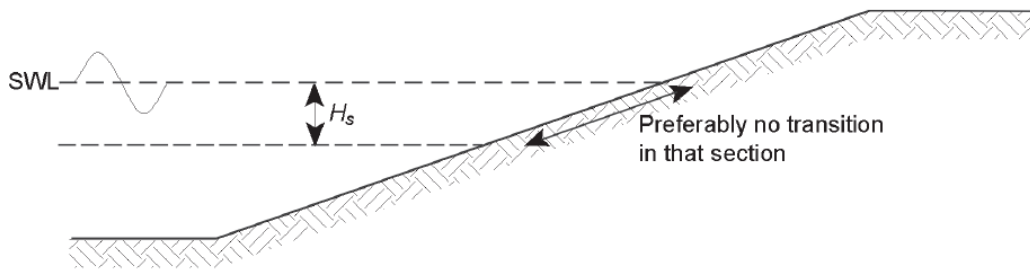

Figure 8.31

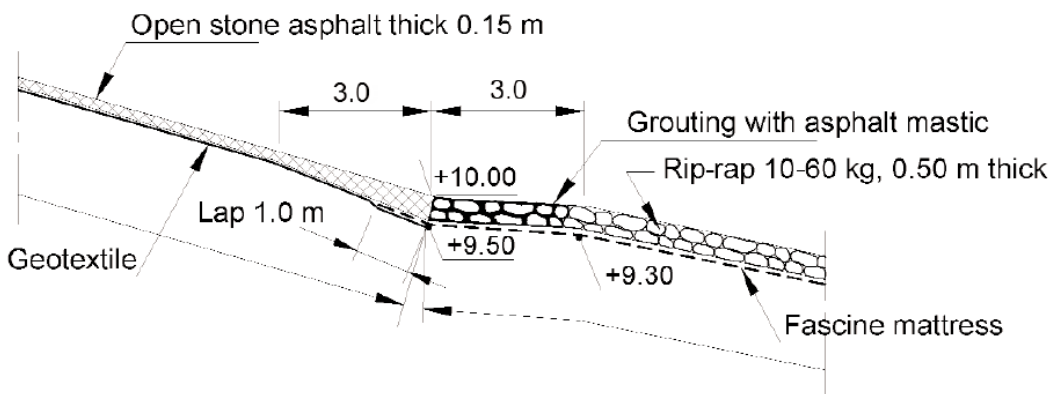

Figure 8.32

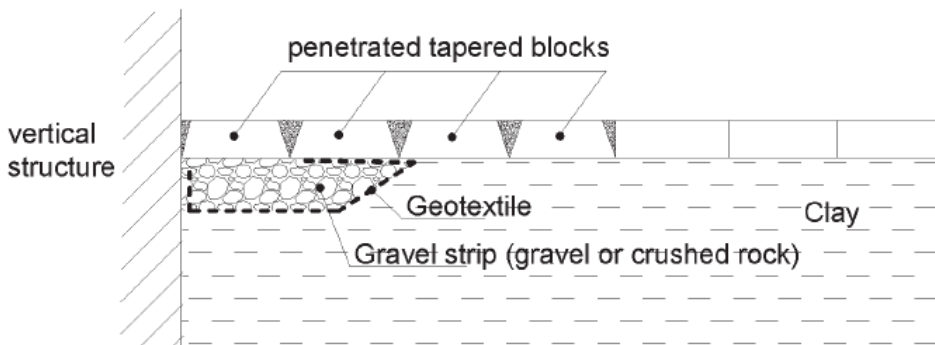

Figure 8.39

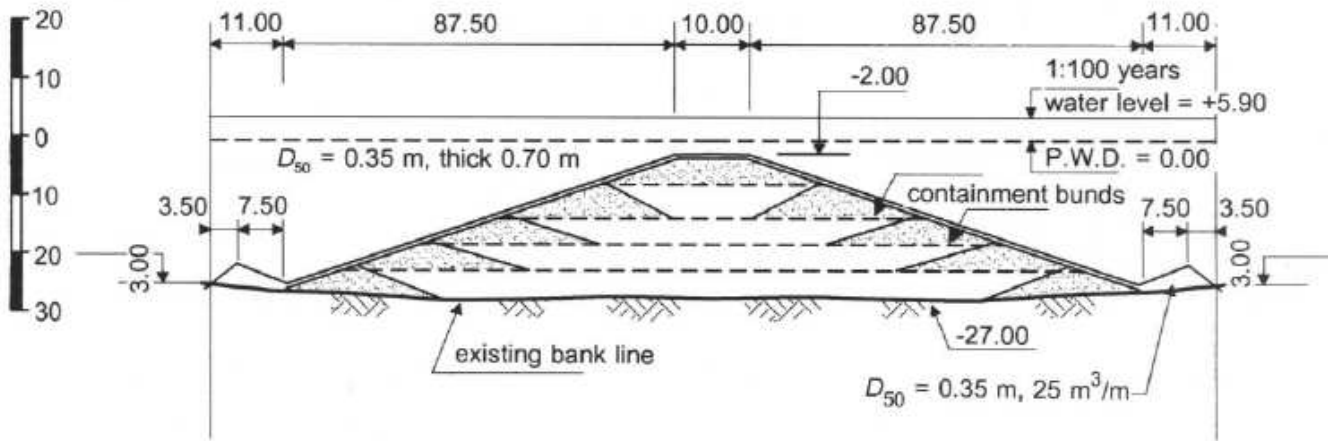

Figure 8.41

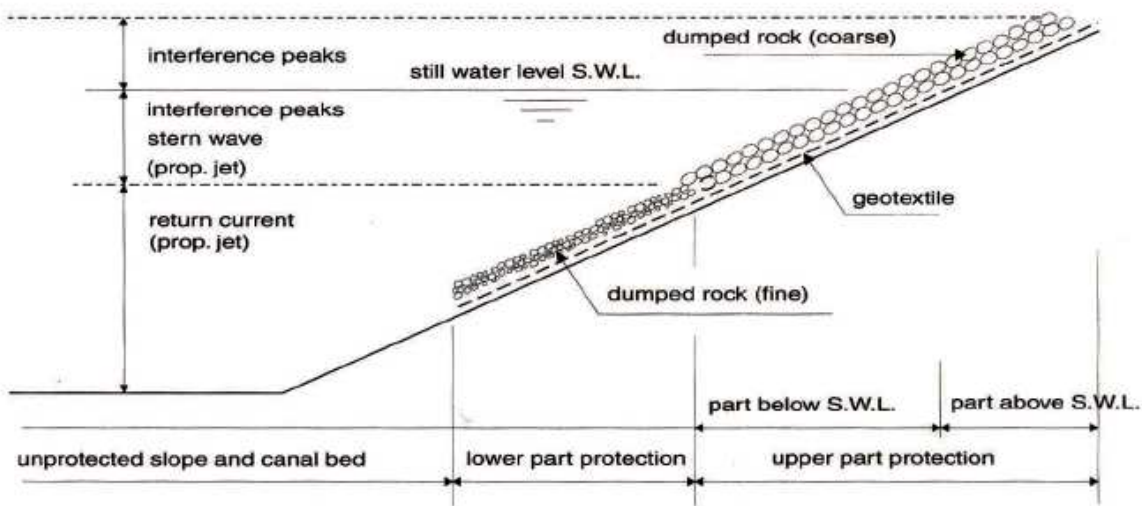

Figure 8.42

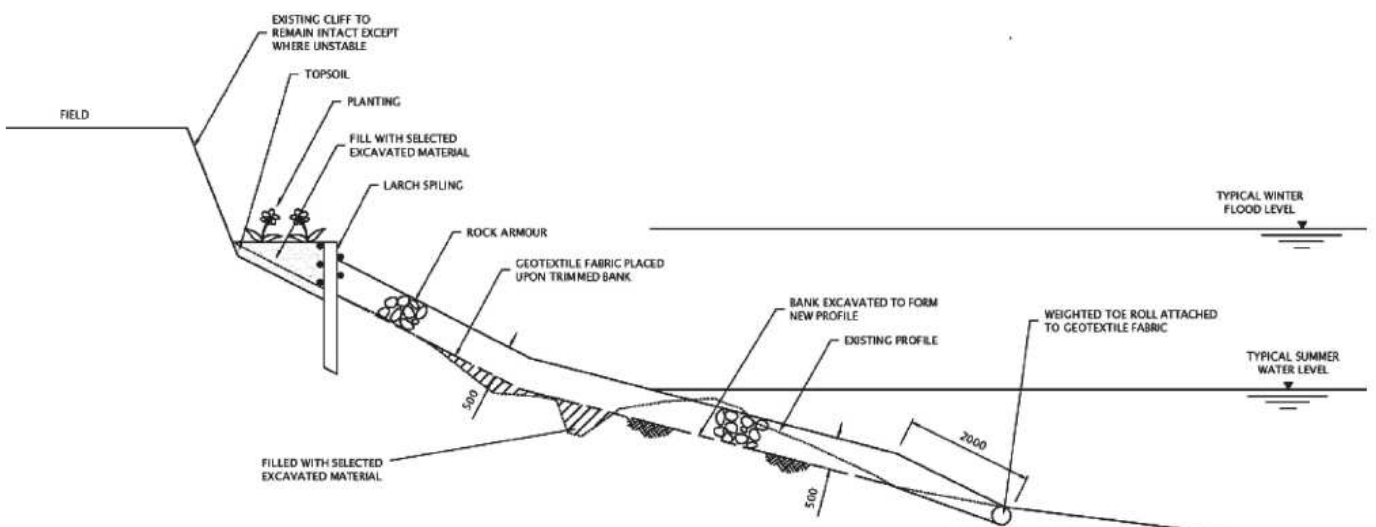

Figure 8.45

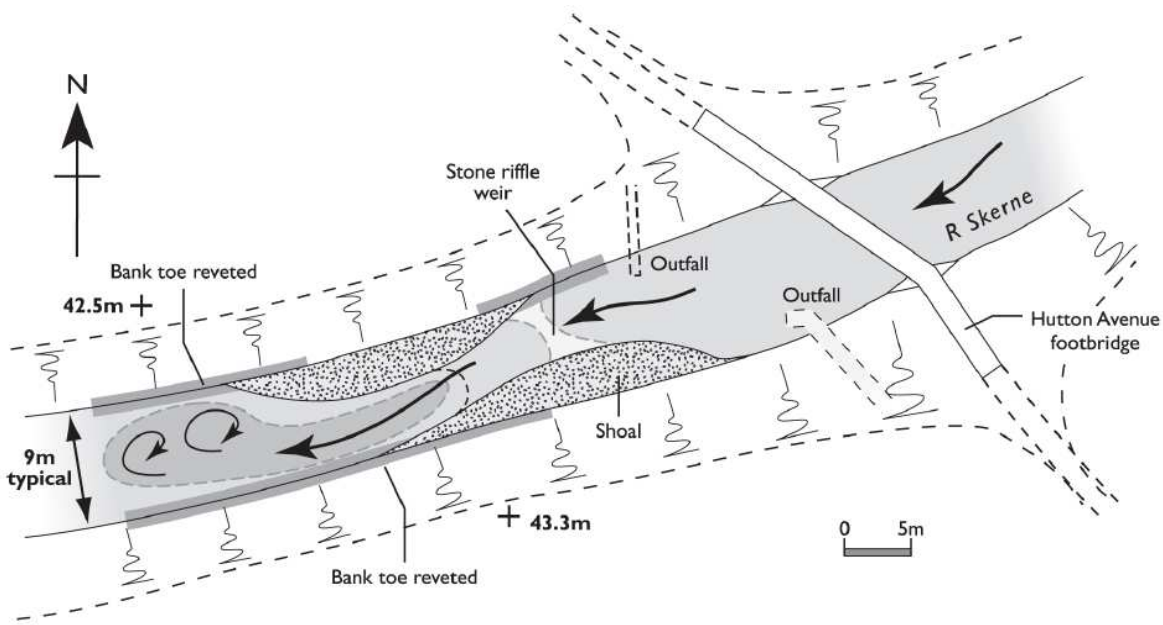

Figure 8.46

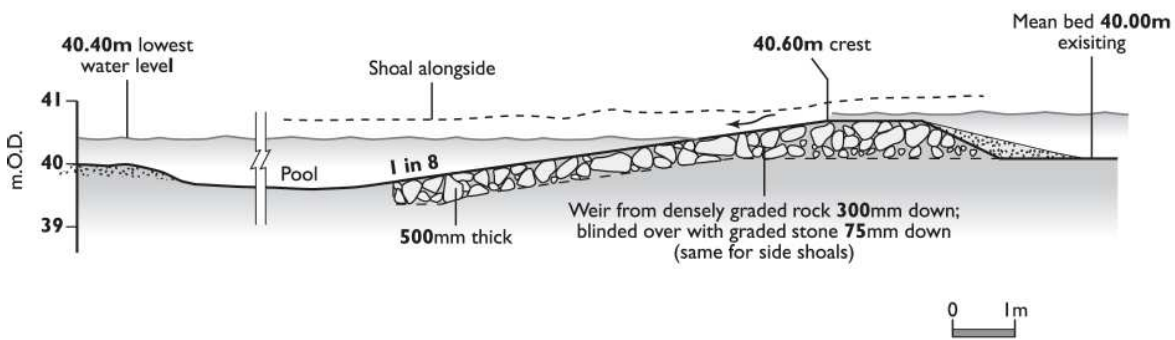

Figure 8.47

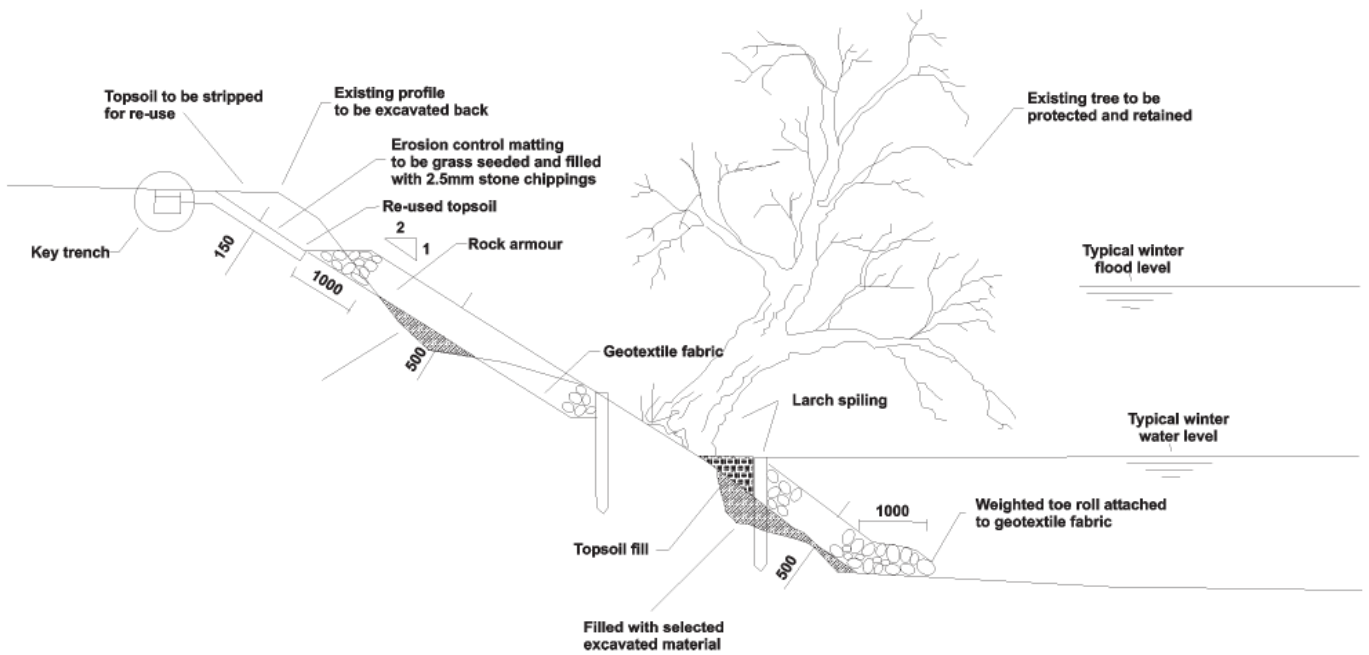

Figure 8.48



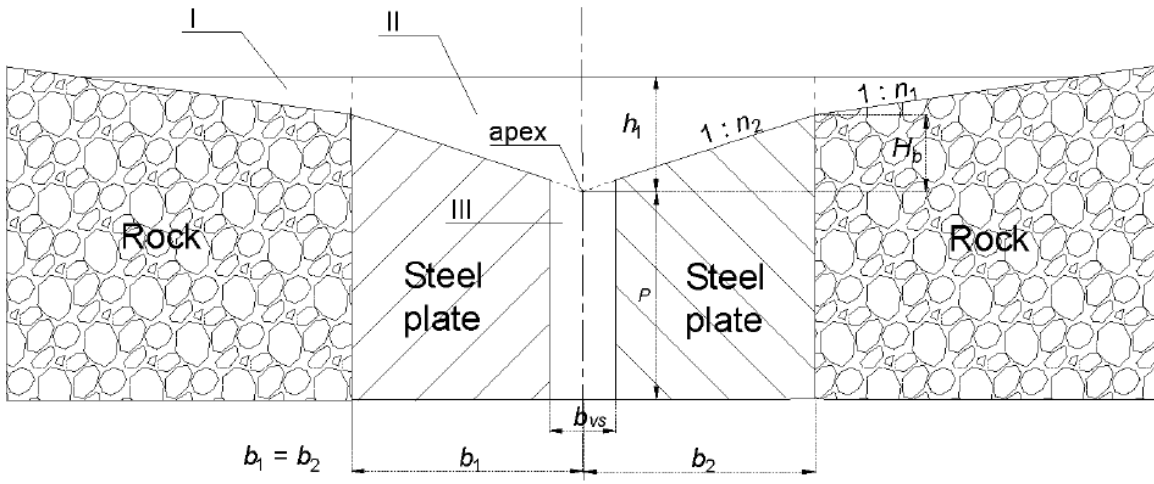

Figure 8.50

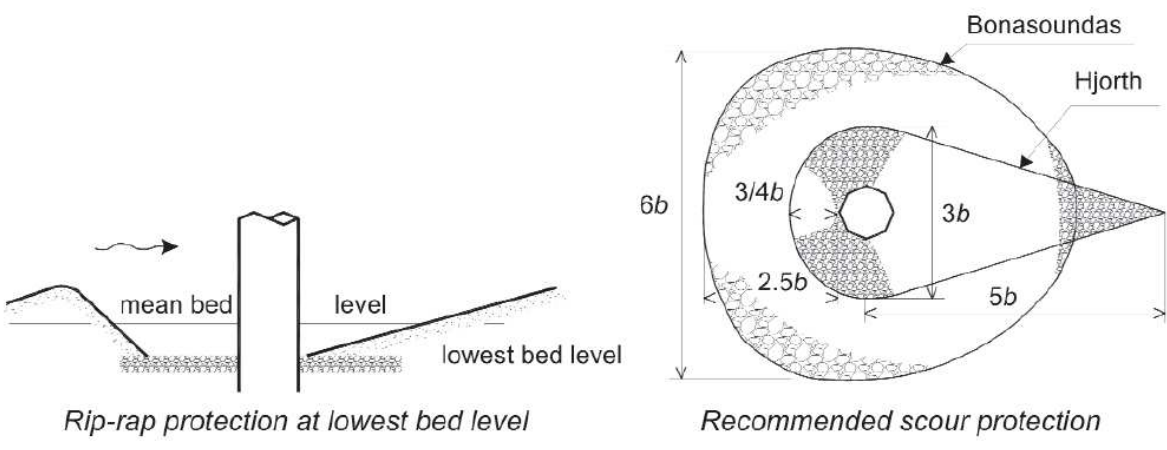

Figure 8.51

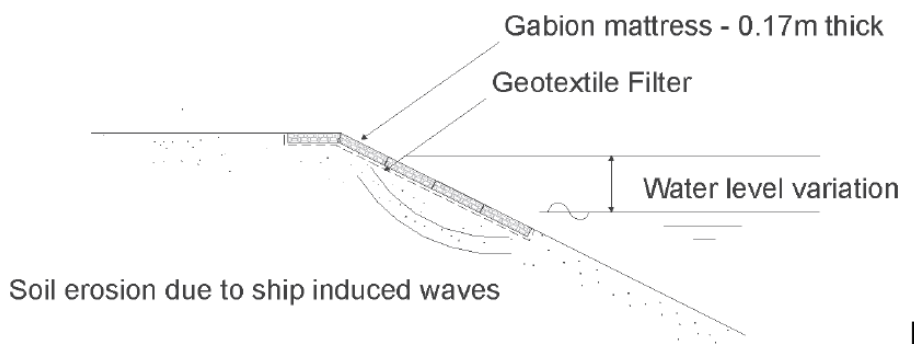
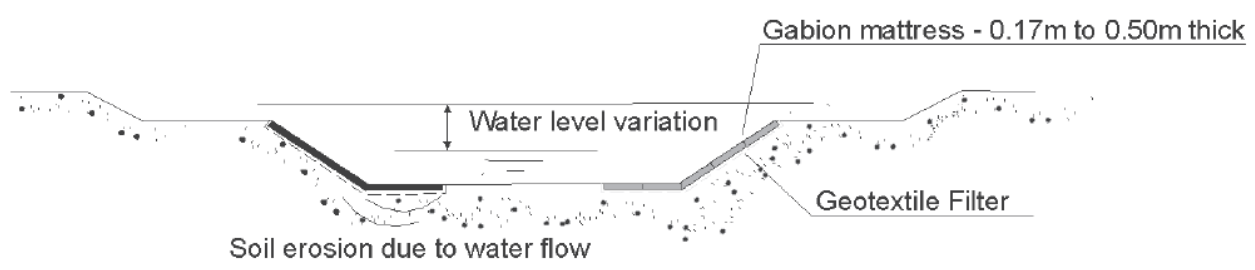

Figure 8.52



Figure

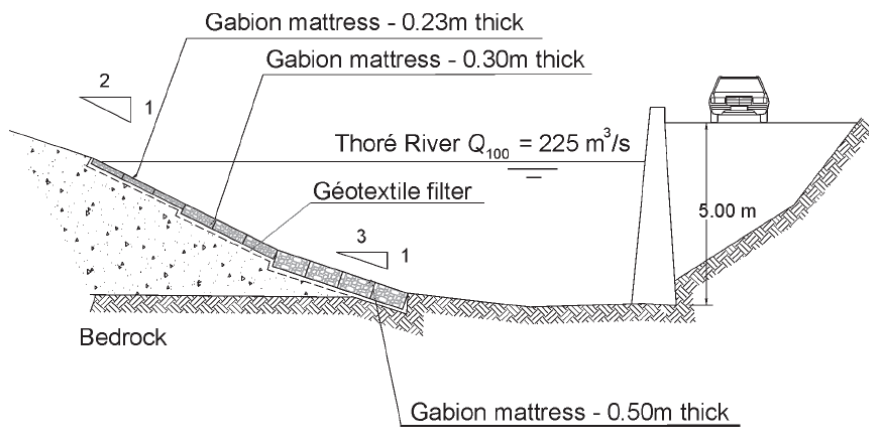

Figure 8.54

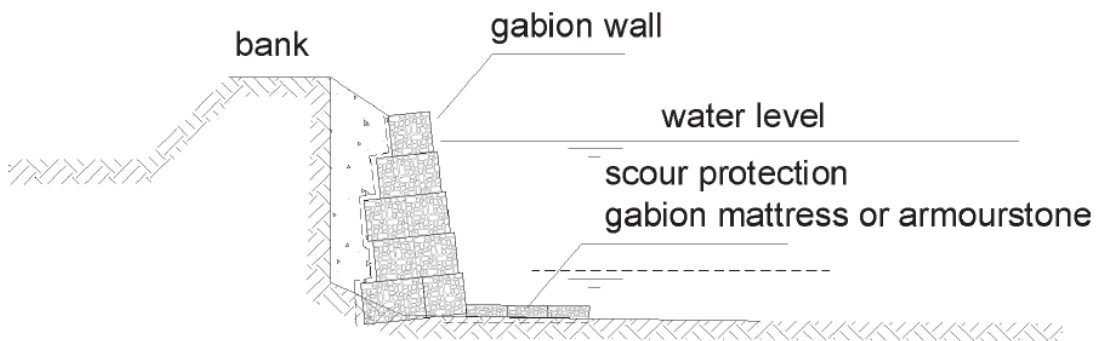

Figure 8.55

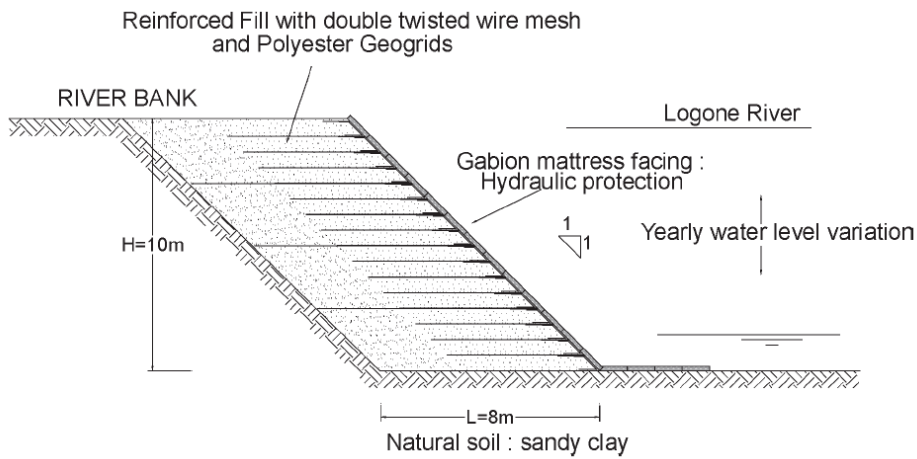

Figure 8.56

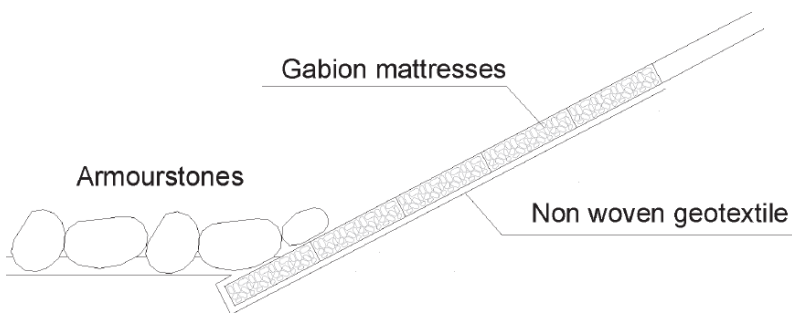

Figure 8.57

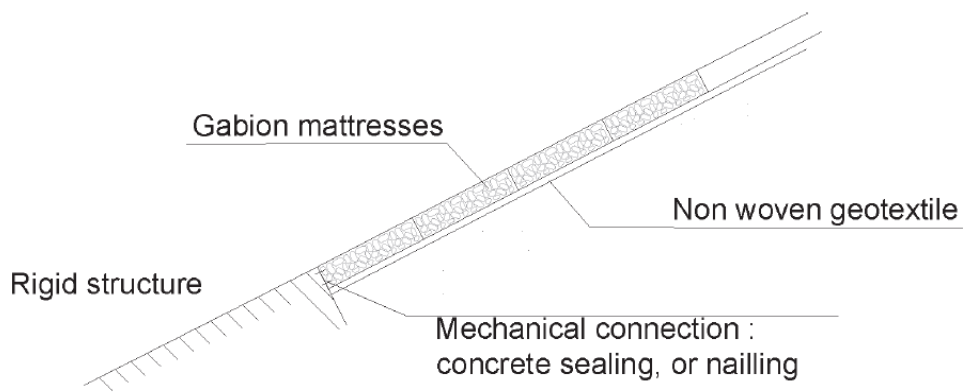

Figure 8.58

Figures of Chapter 9:

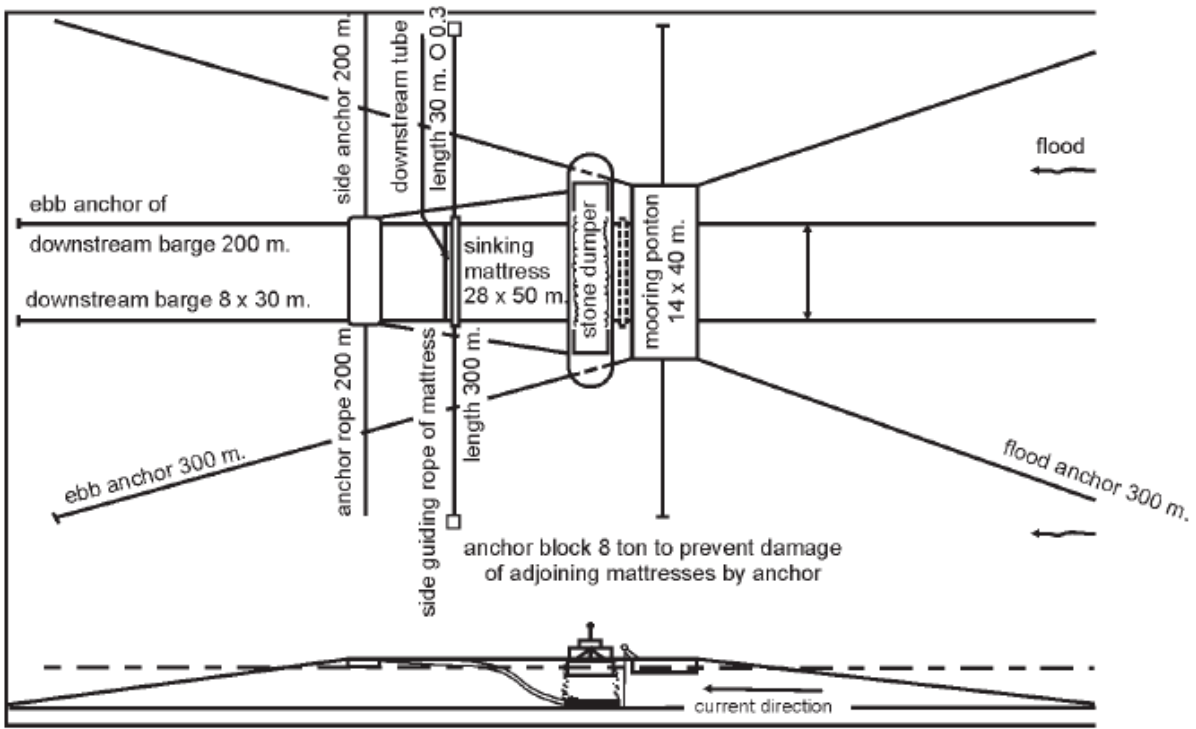

Figure 9.44

Figures of Chapter 10:

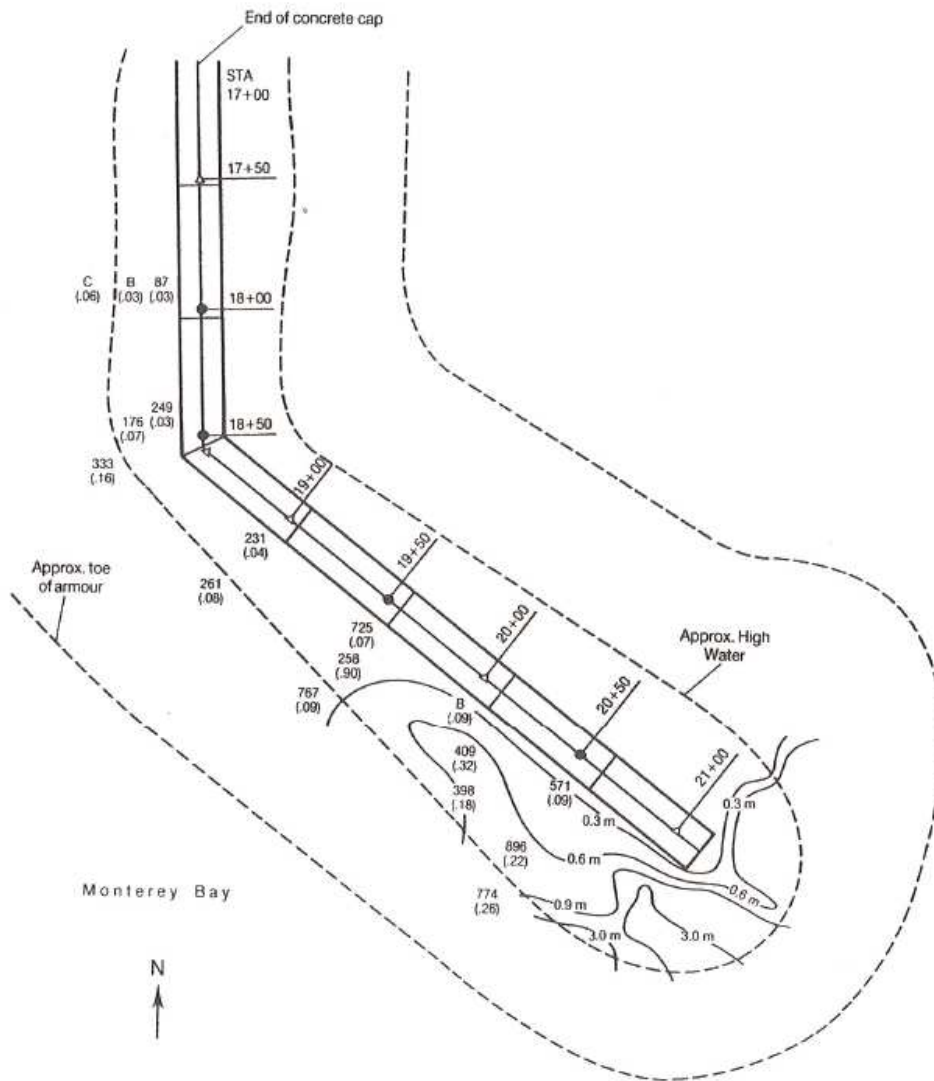

Figure 10.8

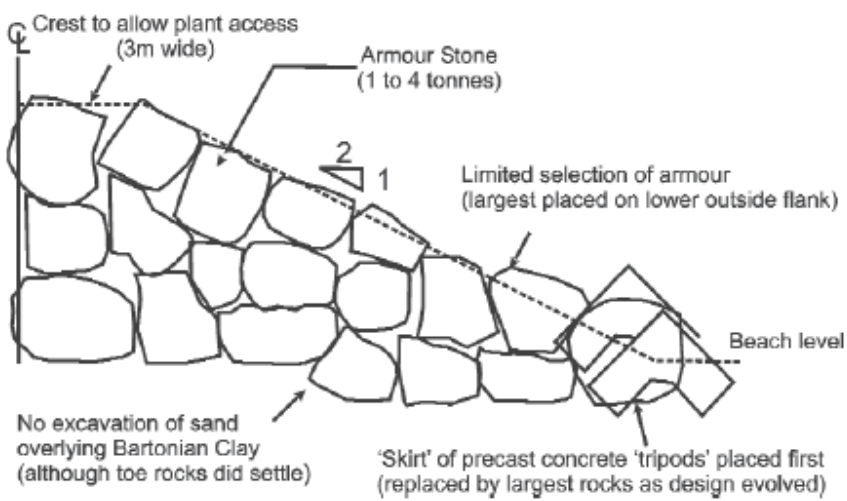
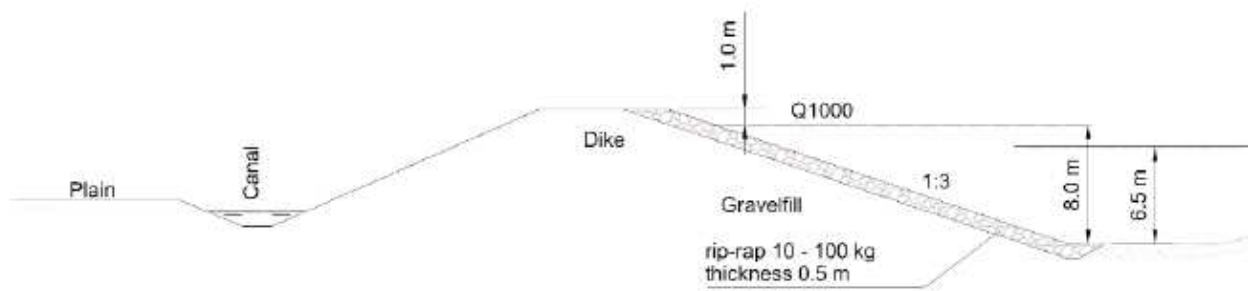
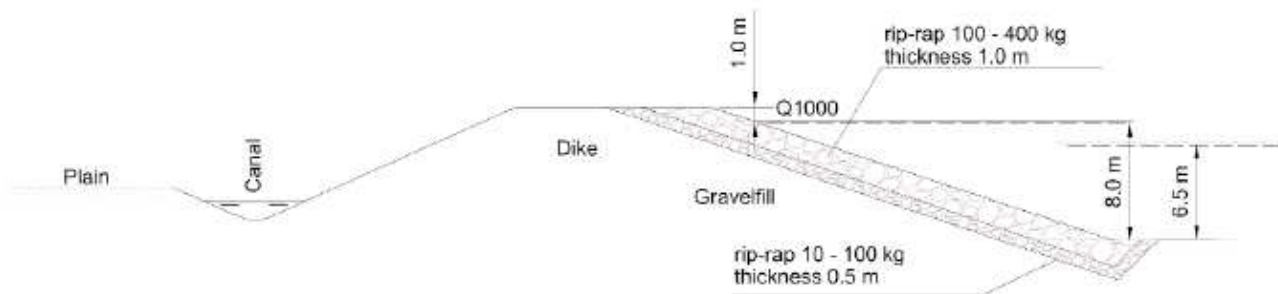

Figure 10.17



Normal exposure



High exposure

Figure 10.20